

Multi-objective Optimization of Plug-in Hybrid Electric Vehicle (PHEV) Powertrain Families Considering Variable Drive Cycles and User Types over the Vehicle Lifecycle

by

S Ehtesham Al Hanif

BSc, Bangladesh University of Engineering and Technology, 2010

A Thesis Submitted in Partial Fulfillment
of the Requirements for the Degree of

MASTER OF APPLIED SCIENCE

in the Department of Mechanical Engineering

© S Ehtesham Al Hanif, 2015
University of Victoria

All rights reserved. This thesis may not be reproduced in whole or in part, by photocopy or other means, without the permission of the author.

Supervisory Committee

Multi-objective Optimization of Plug-in Hybrid Electric Vehicle (PHEV) Powertrain Families Considering Variable Drive Cycles and User Types over the Vehicle Lifecycle

by

S Ehtesham Al Hanif
BSc, Bangladesh University of Engineering and Technology, 2010

Supervisory Committee

Dr. Curran Crawford, (Department of Mechanical Engineering)
Supervisor

Dr. Zuomin Dong, (Department of Mechanical Engineering)
Departmental Member

Abstract

Supervisory Committee

Dr. Curran Crawford, (Department of Mechanical Engineering)
Supervisor

Dr. Zuomin Dong, (Department of Mechanical Engineering)
Departmental Member

Plug-in Hybrid Electric vehicle (PHEV) technology has the potential to reduce operational costs, greenhouse gas (GHG) emissions, and gasoline consumption in the transportation market. However, the net benefits of using a PHEV depend critically on several aspects, such as individual travel patterns, vehicle powertrain design and battery technology. To examine these effects, a multi-objective optimization model was developed integrating vehicle physics simulations through a Matlab/Simulink model, battery durability, and Canadian driving survey data. Moreover, all the drivetrains are controlled implicitly by the ADVISOR powertrain simulation and analysis tool. The simulated model identifies Pareto optimal vehicle powertrain configurations using a multi-objective Pareto front pursuing genetic algorithm by varying combinations of powertrain components and allocation of vehicles to consumers for the least operational cost, and powertrain cost under various driving assumptions. A sensitivity analysis over the foremost cost parameters is included in determining the robustness of the optimized solution of the simulated model in the presence of uncertainty. Here, a comparative study is also established between conventional and hybrid electric vehicles (HEVs) to PHEVs with equivalent optimized solutions, size and performance (similar to Toyota Prius) under both the urban and highway driving environments. In addition, breakeven point analysis is carried out that indicates PHEV lifecycle cost must fall within a few percent of CVs or HEVs to become both the environmentally friendly and cost-effective transportation solutions. Finally, PHEV classes (a platform with multiple powertrain architectures) are optimized taking into account consumer diversity over various classes of light-duty vehicle to investigate consumer-appropriate architectures and manufacturer opportunities for vehicle fleet development utilizing simplified techno-financial analysis.

Table of Contents

| | |
|--|-----|
| Supervisory Committee | ii |
| Abstract | iii |
| Table of Contents | iv |
| List of Tables | vi |
| List of Figures | vii |
| Acknowledgments..... | ix |
| Dedication | x |
| Chapter 1: Introduction | 1 |
| 1.1 Research Motivation | 1 |
| 1.2 Research Outline | 5 |
| 1.3 Organization of Thesis | 7 |
| Chapter 2: Literature Review | 9 |
| 2.1 History of Electric-drive Vehicles | 9 |
| 2.2 Benefits of Vehicle Hybridization or Electrification | 12 |
| 2.3 Degrees of Powertrain Electrification | 15 |
| 2.3.1 Hybrid Electric Vehicles (HEV) | 15 |
| 2.3.2 Plug-in Hybrid Electric Vehicles | 17 |
| 2.3.3 Electric Vehicles (EV) | 18 |
| 2.4 Hybrid Powertrain Architecture..... | 19 |
| 2.4.1 Series Architecture | 20 |
| 2.4.2 Parallel Architecture | 21 |
| 2.4.3 Split Architecture | 22 |
| 2.5 Technology Roadmaps of PHEV in the Market | 23 |
| Chapter 3: Vehicle Model Development and Simulation | 20 |
| 3.1 Significance of Computerized Simulation Model..... | 21 |
| 3.2 Advanced Vehicle Simulator (ADVISOR)..... | 22 |
| 3.3 Baseline Vehicle Platform | 25 |
| 3.4 Powertrain Component Selection | 27 |
| 3.4.1 Internal Combustion Engine (ICE) | 27 |
| 3.4.2 Electric Motor and Generator | 28 |
| 3.4.3 Energy Storage System (ESS) | 29 |
| 3.5 Drive Cycles..... | 31 |
| 3.5.1 Urban Dynamometer Driving Schedule (UDDS) | 32 |
| 3.5.2 Highway Fuel Economy Test (HWFET) | 32 |
| 3.6 Control Strategies (CS)..... | 33 |
| 3.7 Utility Factors (UF)..... | 36 |
| 3.8 Simulation Model Validation..... | 38 |
| 3.9 Simulation Run | 40 |
| Chapter 4: Cost Modeling..... | 42 |
| 4.1 Powertrain Component Cost Modeling | 43 |
| 4.1.1 Engine Cost..... | 43 |
| 4.1.2 Electric Motor Cost..... | 44 |

| | |
|---|-----|
| 4.1.3 Battery Pack Cost..... | 45 |
| 4.2 Battery Replacement Cost..... | 46 |
| 4.3 Powertrain Cost..... | 47 |
| 4.4 Operational Cost | 48 |
| 4.5 Total Cost of Ownership (TCO) | 49 |
| Chapter 5: Methodology | 52 |
| 5.1 Overview of Methodology..... | 52 |
| 5.2 Optimization Approach..... | 53 |
| 5.2.1 Objective Functions | 54 |
| 5.2.2 Design Variables..... | 54 |
| 5.2.3 Design Constraints | 56 |
| 5.2.4 Pareto Search Multi-Objective Optimization Algorithm..... | 58 |
| 5.3 Linking of MATLAB Optimization Routine and ADVISOR Vehicle Model | 62 |
| Chapter 6: Results and Discussion..... | 64 |
| 6.1 Paper 1 – Optimization of Hybrid Electric Vehicles | 64 |
| 6.1.1 Effect of Driving Cycle on Component Sizing..... | 65 |
| 6.1.2 HEV Powertrain Optimization: Single vs. Multiple Driving Cycle | 70 |
| 6.1.3 Effect of Sensitivity Analysis on Powertrain Cost | 71 |
| 6.1.4 HEV vs. CV Selection Decision | 75 |
| 6.2 Paper 2 – Optimization of Plug-in Hybrid Electric Vehicles | 78 |
| 6.2.1 Impact of Driving Cycle on Component Sizing | 79 |
| 6.2.2 Effect of Sensitivity Analysis on Total Cost of Ownership (TCO)..... | 84 |
| 6.2.3 Breakeven Point (BEP) Analysis over Lifecycle Cost | 90 |
| 6.2.4 Future Potential of Plug-in Hybrid Electric Vehicle (PHEV) | 95 |
| 6.2.5 Comparison of CV, HEV, and PHEVs | 100 |
| 6.3 Paper 3 – Electric Vehicle Class Optimization..... | 102 |
| 6.3.1 PHEV – Light Duty Vehicle Class Optimization | 102 |
| 6.3.2 Single Platform with Multiple Electric Drivelines | 107 |
| Chapter 7: Conclusions and Future Work..... | 115 |
| 7.1 Conclusions..... | 115 |
| 7.2 Contribution of Thesis Work | 117 |
| 7.3 Limitations and Future Work..... | 119 |
| Bibliography | 122 |
| Appendix A. Determination of All Electric Range (AER)..... | 132 |
| Appendix B. Aggressiveness of Drive Cycles..... | 133 |
| Appendix C. PHEV Family data for various Combination of Powertrain Components | 134 |

List of Tables

| | |
|---|-----|
| Table 1 Basic parameters of the 2012 Toyota Prius PHEV [68] | 26 |
| Table 2 General characteristics of drive cycles [70], [74] | 33 |
| Table 3 Validation Results – UDDS drive cycles during both CD and CS modes [81]... | 39 |
| Table 4 All Electric Mode – Energy and Capacity Usage Validation [66] | 40 |
| Table 5 Upper and lower bound of design variables | 55 |
| Table 6 Parameter levels for sensitivity analyses | 72 |
| Table 7 Sensitivity analysis of key cost parameters | 85 |
| Table 8 Gasoline savings and powertrain incremental cost based on baseline CV | 97 |
| Table 9 Light-duty passenger vehicle classification by US EPA [115]..... | 103 |
| Table 10 Light-duty passenger vehicle classification by US NHTSA [116], [117] | 103 |
| Table 11 Vehicle attributes of light-duty vehicle classes [113], [118], [119] | 104 |
| Table 12 Comparative powertrain component sizing of various light-duty vehicles | 105 |
| Table 13 Vehicle choice scenario for Class A user based on lifetime savings..... | 109 |
| Table 14 Vehicle choice scenario for Class B user based on lifetime savings | 110 |
| Table 15 Vehicle choice scenario for Class C user based on lifetime savings | 111 |
| Table 16 Vehicle choice scenario for Class D user based on lifetime savings..... | 112 |
| Table 17 Comparison among PHEV family optimum configurations..... | 113 |
| Table 18 BEV family data for various combination of powertrain components | 135 |
| Table 19 PHEV family data for various combination of powertrain components | 136 |
| Table 20 HEV family data for various combination of powertrain components..... | 136 |

List of Figures

| | |
|--|----|
| Figure 1 Energy consumption in North America by sector [4], [5]..... | 1 |
| Figure 2 Greenhouse Gas (GHG) emissions in Canada for Energy Sector [7] | 2 |
| Figure 3 Development trend of Alternative Vehicle Technology [11]..... | 4 |
| Figure 4 Application of renewable sources in vehicle charging..... | 14 |
| Figure 5 Operational modes of hybrid powertrain components | 16 |
| Figure 6 Aspects of Plug-in Hybrid Electric Vehicle (PHEV) [58] (Source: Toyota) | 18 |
| Figure 7 Various size of Electric Vehicles (EV) [59]..... | 19 |
| Figure 8 Series Hybrid Powertrain Architecture | 20 |
| Figure 9 Parallel Hybrid Powertrain Architecture | 21 |
| Figure 10 Split (Series – Parallel) Hybrid Powertrain Architecture | 23 |
| Figure 11 Annual light-duty vehicle sales by technology type [65]..... | 23 |
| Figure 12 ADVISOR model definition employs linked library architecture [67] | 23 |
| Figure 13 Flow chart of a backward, and forward facing modeling approach | 24 |
| Figure 14 ADVISOR/Simulink block diagram of a Toyota Prius PHEV | 24 |
| Figure 15 Structural design of baseline vehicle platform | 27 |
| Figure 16 Toyota Prius engine efficiency map [71] | 28 |
| Figure 17 Motor/Generator efficiency map [72] | 29 |
| Figure 18 State of charge of a PHEV battery pack..... | 30 |
| Figure 19 UDDS driving cycles..... | 32 |
| Figure 20 HWFET driving cycle | 33 |
| Figure 21 Control Strategy SOC Behaviour | 34 |
| Figure 22 Simplified engine ON/OFF logic | 35 |
| Figure 23 Utility factor calculation method [78]..... | 36 |
| Figure 24 Utility Curve of Canadian fleet data for 150,000 user [80]..... | 37 |
| Figure 25 Explanation of Utility Factor (UF)..... | 37 |
| Figure 26 Interactive powertrain simulation window | 41 |
| Figure 27 Engine cost as a function of engine power [83] | 43 |
| Figure 28 Theoretical and practical energy density of various batteries [84]..... | 45 |
| Figure 29 Total cost of ownership calculations | 50 |
| Figure 30 Driveability constraints | 56 |
| Figure 31 Pareto optimal solution searching technique..... | 60 |
| Figure 32 Iterative process of NSGA-II..... | 60 |
| Figure 33 Linking of Optimization routine and ADVISOR vehicle model..... | 62 |
| Figure 34 Pareto Solution of HEVs on City (UDDS) drive cycle | 65 |
| Figure 35 Pareto Solution of HEVs on Highway (HWFET) drive cycle | 66 |
| Figure 36 Pareto Optimized solution over UDDS driving conditions..... | 67 |
| Figure 37 Pareto Optimized solution over HWFET driving conditions | 68 |
| Figure 38 Vehicle acceleration performance on UDDS driving condition..... | 69 |
| Figure 39 Vehicle acceleration performance on HWFET driving condition..... | 69 |
| Figure 40 Pareto Optimized solution over City + Hwy driving conditions | 70 |
| Figure 41 Powertrain Costs distribution among components (Nominal) | 71 |
| Figure 42 Sensitivity Analysis over UDDS drive cycle | 73 |

| | |
|--|-----|
| Figure 43 Sensitivity Analysis over HWFET drive cycle | 74 |
| Figure 44 Tipping point calculation on TCO w/o battery replacement | 77 |
| Figure 45 Tipping point calculation on TCO with battery replacement | 77 |
| Figure 46 Powertrain vs. Operational cost over UDDS drive cycle | 79 |
| Figure 47 Powertrain vs. Operational cost over HWFET drive cycle | 80 |
| Figure 48 Pareto solution of powertrain component sizing over UDDS drive cycle | 81 |
| Figure 49 Pareto solution of powertrain component sizing over HWFET drive cycles ... | 81 |
| Figure 50 Powertrain cost for different drive cycles | 82 |
| Figure 51 Operational cost for different drive cycles | 82 |
| Figure 52 AER ranges for the optimal spectrum of PHEVs | 83 |
| Figure 53 Powertrain cost with respect to charge sustaining and depleting mode | 83 |
| Figure 54 Lifecycle equivalent annualized cost under different drive cycles | 86 |
| Figure 55 Sensitivity Analysis of key cost parameters over TCO of Split PHEV | 87 |
| Figure 56 Sensitivity Analysis of key cost parameters over TCO of Series PHEV | 88 |
| Figure 57 Sensitivity Analysis of key cost parameters over TCO of Parallel PHEV | 89 |
| Figure 58 BEP analysis for the cost of CV and HEV by altering gasoline price | 91 |
| Figure 59 BEP analysis for the cost of CV and PHEVs by altering gasoline price | 93 |
| Figure 60 BEP analysis for the cost of CV and PHEVs by altering electricity price | 94 |
| Figure 61 Daily mileage distribution of Canadian motorists | 95 |
| Figure 62 Powertrain costs and reduction of gasoline consumption for PHEVs | 96 |
| Figure 63 TCO over vehicle lifetime without ESS replacement | 98 |
| Figure 64 TCO over vehicle lifetime with ESS replacement | 99 |
| Figure 65 Comparison of powertrain and operational cost among different PHEVs | 101 |
| Figure 66 Light-duty vehicle classification | 104 |
| Figure 67 Comparative operational cost analysis over different light-duty vehicles | 106 |
| Figure 68 Comparative powertrain cost analysis over various light-duty vehicles | 106 |
| Figure 69 User classification with respect to daily driving distance [80], [122] | 107 |
| Figure 70 AER capable PHEV operating over a FCT | 132 |
| Figure 71 Aggressiveness of driving cycle | 133 |
| Figure 72 Powertrain vs. Operational cost of single platform of PHEV classes | 135 |

Acknowledgments

First and foremost, I would like to thank my supervisor Dr. Curran Crawford, for his invaluable guidance, patience, and persistent support throughout this learning process. I thank him for involving me in this project and having confidence in my abilities to handle such an intricate research topic. Without his supervision and motivation, it was not possible for me to dive into the depth of the theoretical aspects of the research work while developing computational engineering approach in solving the technical problems simultaneously.

I am grateful to Dr. Zuomin Dong, for sharing expertise, valuable suggestions and encouragements extended to me during this research. I would also like to extend my thanks to John Jancowski-Walsh, Jian Dong, Joshua Yin and all my other colleagues at the Institute for Integrated Energy Systems at the University of Victoria's (IESVic) and the Sustainable Systems Design Laboratory (SSDL). Financial support from ecoENERGY Innovation Initiative (ecoEII) of Natural Resources Canada (NRCan) and BC funding, for this research, is gratefully acknowledged. Finally, I thank my parents (Dr. Abu Hanif Sheikh, Shahina Pervin), parent-in-laws (Dr. Hamidur Rahman, Dr. Bilkis Begum) and my wife (Himika Rahman), who have always supported me in this journey.

Dedication

I would like to dedicate this work to my parents and beloved wife.

Chapter 1: Introduction

1.1 Research Motivation

As the global economy makes every effort towards using clean and sustainable energy due to climate change concerns, growing eco-friendly awareness and security concerns associated with petroleum energy as sources become progressively scarce, all the technologies that show possible prospective for reducing energy usage are being assessed as an alternative sources of energy. In industrialized countries, most of the petroleum is used for fueling transportation. Whereas North America, which consumes more than one-fourth of the worldwide production of oil (shown in Figure 1), the transportation sector alone is using more than two-third of that petroleum [1], [2]. Moreover, due to the rapid economic growth in places such as Asia like China, India and other developing countries in the rest of the world, road vehicles are projected to be 5 to 6 times more in the next 15 to 20 years' time [3].

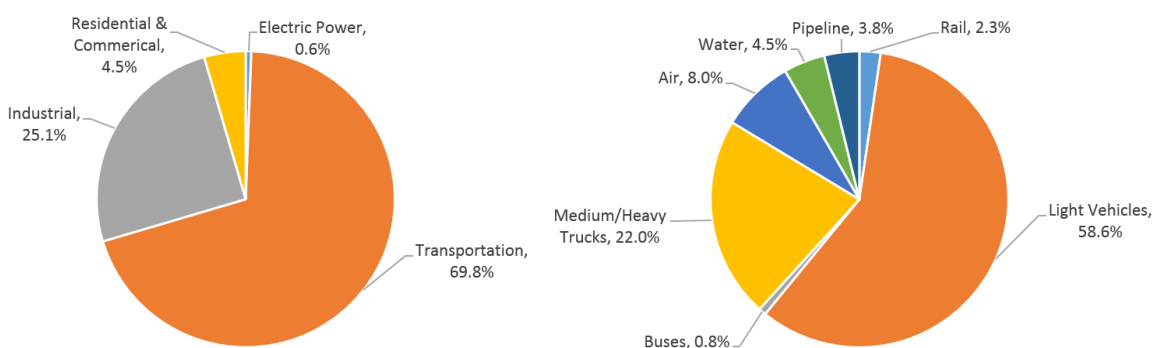

Figure 1 Energy consumption in North America by sector [4], [5]

But, the petroleum is a finite resource and gasoline price currently became unpredictable, and it could be a very expensive energy source in the future. Also, the consumption of hydrocarbon fuels releases CO₂ into the atmosphere, and CO₂ is the most concentrated

green-house-gas (GHG), which is raising concerns with regards to global warming. Since, transportations are currently a key source of air pollution, major automakers and several governments of developed countries are working in partnership to deliver a solution that will result in decreasing vehicle GHG emissions while reducing the consumption of petroleum. Different manufacturers currently research various forms of fossil fuel reduction methods and alternative energy sources. One such new technology is a hybridization of powertrain technology that means it has a secondary power source to drive that vehicle. Once in an interview, the president of Toyota Motor Sales of USA, Mr. Jim Press was asked about the future of vehicle powertrain electrification, at that time he mentioned the Press, “I think eventually everything will be either a hybrid or electric. It will be either a gasoline hybrid, a full battery electric vehicle or a fuel-cell hybrid” [6]. However, according to a recent greenhouse gas inventory survey in the province of British Columbia (BC), Canada estimated that over 20 % (shown in Figure 2) of the total emissions came from the use of light-duty or passenger vehicle [7] which is also true for North America; such as it is over 35 % in the US.

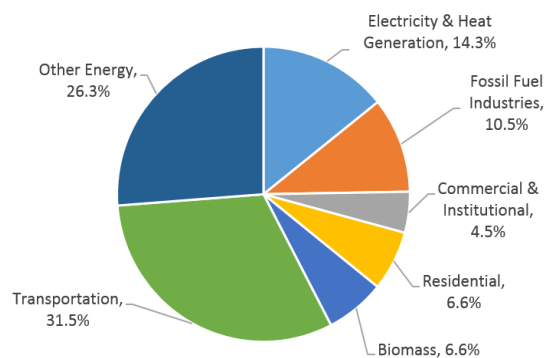

Figure 2 Greenhouse Gas (GHG) emissions in Canada for Energy Sector [7]

The vast majority of these vehicles derived energy from either gasoline or diesel, with little or no alternative to the type of fuel used. These scenarios influence most of the

major automobile manufacturers to design either plug-in hybrid electric vehicle (PHEV) or battery electric vehicle (BEV, also known as only EV). While there are some vehicle technologies and drivetrain arrangements that are considered by the manufacturer. Therefore, this thesis will focus on both near and long-term benefits of PHEV technologies.

A PHEV is a vehicle powered by a combination of internal combustion engine (ICE), one or more electric motors/generators (M/G) with an energy storage system (ESS) that can store energy by plugging into the electric grid. The advantages of a plug-in hybrid electric vehicle are evaluated based on their competence to displace gasoline energy for transportation with electrical energy produced by multiple sources. Moreover, the PHEV would be much more beneficial compared to a gasoline driven Conventional Vehicle (CV) if the electrical energies are coming from renewable sources like a wind turbine, solar power, etc. It can also travel using two separate kinds of energy sources; such as petroleum and electricity. Due to the hybrid drivetrain architecture, it has numerous extra benefits in terms of improving the operational efficiency of a vehicle. Such as [8], [9]:

- (1) The motor assists the internal combustion engine to run mostly at maximum efficiency load point by operating the batteries to fulfill the required power demand.
- (2) Due to the presence of supplementary power source in the form of the electric motor that empowers powertrain designers to choose the smaller engine with lower torque and higher efficiency.

- (3) The PHEV powertrains are able to capture the energy that is typically lost during coasting to re-charge the battery and shutting off the engine rather than idling.
- (4) The PHEVs are reducing the dependency on petroleum by utilizing energy from the electric grid instead of burning gasoline.

Therefore, a PHEV has lower fuel consumption consequently lower operational costs and green-house-gas emission (GHG) benefits of an EV and does not have a range anxiety issue like CV, but at a higher retail price than a typical CV due to the integration of more powertrain components. However, many vehicle manufacturers have already started working on the development of PHEVs like Toyota Prius, Chevy Volt, Ford Fusion, Ford C-Max, Mitsubishi MiEV, BMW i8, etc. [10].

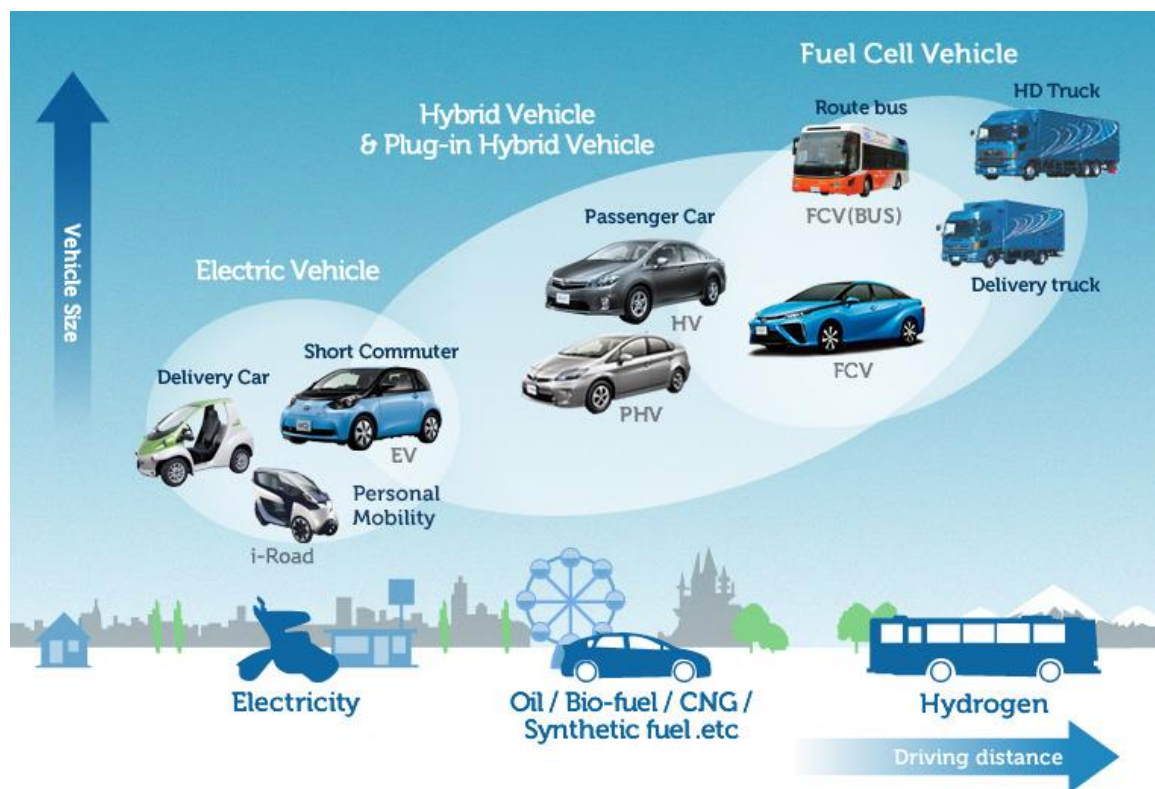

Figure 3 Development trend of Alternative Vehicle Technology [11]

Since their introductions in world-market, buyers' acceptability, the potentiality of vehicle technology, and commercial benefits of PHEVs are not well established for the vehicle user. A numerous research studies are conducted under the sponsorship of automobile manufacturers or government agencies in order to evaluate the market potential of hybrid and plug-in hybrid vehicles with respect to fuel economy and incremental vehicle costs [12]–[18]. The conclusion of all of those studies is to reduce the manufacturing cost difference in between conventional and hybrid vehicles through technological advancements in order to gain consumers acceptance in terms of socio-economic viability. For a user, it becomes difficult to select an ideal vehicle that would be most cost-effective during its lifetime just only based on the incremental cost difference. Thus the necessity of total cost of ownership pops up [19]–[21]. Moreover, most of the studies do not consider any detail component wise simulation models of vehicle powertrain system in order to enable high fidelity vehicle incremental cost estimation.

1.2 Research Outline

The following tasks have been accomplished in this research study:

- a) to develop an optimization process to synthesize a PHEV powertrain optimization by focusing on the operational and the powertrain cost with simultaneous powertrain component (engine, motor/generator and battery) sizing through the utilization of a Pareto front based multi-objective optimization algorithm
- b) to identify optimal hybrid drivetrain performance from a pool of combinations (involving batteries, permanent magnet electric motors and engines), by

simulating PHEV vehicles with respect to CV and HEV based on the Toyota Prius platform under two different drive cycles: US EPA – Urban Dynamometer Driving Schedule (UDDS) and Highway Fuel Economy Test (HWFET) using ADVISOR

- c) to conduct sensitivity and breakeven point analysis of the simplified total cost of ownership (TCO) for various vehicle configurations over the vehicle lifetime under different scenarios including driving patterns and consumer acceptability
- d) to observe the potential of PHEV technology across the vehicle classes (light-duty class and level of powertrain electrification) by integrating consumers diversity and the fleet data of daily driving distance with their utility factors (UF) without sacrificing vehicle performance

This research utilizes a simplified PHEV design optimization model in terms of cost and drivetrain components. This model may be utilized to estimate a preliminary vehicle powertrain design including HEV, PHEV and EV with respect to energy source selection and drivetrain component sizing, driving patterns, as well as evaluating and improving performance through modifications of control strategy. Innumerable driving cycles, comprehensive TCO (including maintenance cost, government rebate program, carbon-tax, GHG emissions), utilizing different combinations of drivetrain components, and vehicle charging pattern with utility factors can be employed to better understand the limitation of each powertrain system during a specific driving cycles.

1.3 Organization of Thesis

Chapter 2 provides a literature review of the related studies that include various configurations of plug-in hybrid electric vehicles (PHEV) and also provides an overview of existing PHEV designs available on the market.

Chapter 3 presents the PHEV modeling and simulation techniques used to model Toyota Prius in this study. In this chapter, at first the Toyota Prius 2012 vehicle model is described, second the drivetrain configurations and components used for modeling using ADVISOR vehicle simulator are outlined, and finally the simulation setup and running process for both US Environment Protection Agency (EPA) UDDS and HWFET drive cycles are defined.

Chapter 4 mentions the development of the cost models for powertrain components, the operational and total cost of ownership based on available manufacturing information.

Chapter 5 describes the hybridization and multi-objective optimization models used for this research. In addition, the model variables, multi-objective functions, and constraints for the optimization are defined. The optimization algorithms used for battery sizing and motor and engine sizing are outlined. The Pareto search techniques used for multi-objective optimization is also described. Comparison of simulation results obtained from MATLAB/SIMULINK simulation platform and ADVISOR will be presented.

Chapter 6 discusses the comparative analysis of PHEV with respect to conventional, hybrid and electric vehicle. All the simulations are based on the MATLAB/ADVISOR powertrain model. City and highway drive cycles are used to simulate the performance and the fuel efficiency of the plug-in hybrid, hybrid and conventional vehicles.

However, this research proposes a multi-objective optimization process through PHEV classes. Furthermore, a comprehensive sensitivity analysis is done over a simplified TCO model to assess the potentiality of PHEV both in short-term and long-term scenarios to satisfy consumers and vehicle architectural diversity.

Finally, Chapter 7 concludes the modeling and simulation of the PHEV model, contribution and application of this research; finally, provide recommendations for further research in this area.

Chapter 2: Literature Review

2.1 History of Electric-drive Vehicles

A significant amount of research has been conducted on electric vehicle technology in the last few years. However, this type of vehicle has been first introduced in the 1830s [22], [23] and later on patented by H. Piper in 1905 [24]. But the simultaneous development of conventional vehicle (CV) technology such as, ability to go longer ranges with easy refueling techniques and reduction of manufacturing cost associated with CV etc. eliminated the necessities of vehicle electrification or hybridization. However, in the early 1970s, due to the climate change, security concerns associated with the oil crisis, and technological developments, electrified vehicle regained attention. Moreover, in beginning of the 1990s, the government of United States (US) launched the Partnership for a New Generation of Vehicles (PNGV) association [25], consisting of giant automakers like General Motors, Ford, and Chrysler along with hundreds of smaller R&D firms. The PNGV had very promising goals regarding vehicle electrification, they also established minimum performance requirements and attributes for the automakers, and otherwise automakers will get a hefty penalty. In early 2000, Japan and Europe also joined in this journey of vehicle drivetrain electrification. Recently, due to California Zero Emission [26] mandate, worldwide oil price fluctuation and government regulations to reduce the global warming, all the attention of automakers gone over the electrification of vehicle powertrain system which includes mass marketization of HEV, PHEV and EVs. Argonne National Laboratory (ANL), University of California Davies, Natural Resources Canada are the current frontiers in PHEV or EV research along with automakers like GM, Ford, Tesla, Mercedes-Benz, BMW and Nissan, etc. Earlier

research by various universities and small firms demonstrated that PHEV can displace oil consumption and greenhouse gas (GHG) emissions by reducing dependency over gasoline. Meanwhile, several comprehensive vehicle powertrain simulators like Powertrain Systems Analysis Toolkit (PSAT) [27], Advanced Vehicle Simulator (ADVISOR) [28], Autonomie [29], GREET [30] etc., are being developed by ANL under the sponsorship of DOE which has allowed for computer based model and the ability to test various kinds of vehicle without even manufacturing and building prototypes.

After the launch of the computerized tools, numerous research is conducted on Plug-in Hybrid Electric Vehicle (PHEV) focusing on either fuel economy or greenhouse gas emissions (GHG). These mainly depend on vehicle powertrain component sizing, control strategy and availability of vehicle technologies. Therefore, a front of PHEV research is concentrating on PHEV design, Energy Storage System (ESS) and control strategy optimization that allows for improved performance of PHEVs. Advancements in technologies such as energy density, durability and electrochemical composition of the energy storage system have enhanced performance and reduced retail price of PHEVs. The focus of research has, therefore, shifted to powertrain component sizing that optimizes the vehicle control strategy [31]. Currently, there is no established procedure to determine the optimal powertrain component sizes for different types of configurations. It's believed to be fuel economy of PHEVs that could be substantially improved by concurrent optimization of control parameters and component sizing. The elementary design process for a PHEV includes a diversity of vehicle powertrain architecture (VPA), the cost function of powertrain components, energy trade-off strategy, charging patterns and grid connections [32].

The studies related to PHEV design mostly focused on vehicle architecture. However, it has been found that weight of the vehicle was a major aspect influencing CO₂ emissions because heavier vehicles need more energy as they need to move an extra weight, so more fuel is consumed, thereby resulting in increased emissions [33], [34]. In order to test the All Electric Range (AER) capacity and performance of PHEVs over full-charge (FCT), model-based design tool have been developed for different architecture selection, component sizing, and control algorithms [35], [36]. Rousseau et al. studied the control strategy parameter optimization of a Parallel PHEV model using PSAT [37], [38]. A non-gradient based optimization algorithm was used to optimize the critical parameters of the control strategy. They also highlighted the necessities of powertrain component optimization such as engine size, motor or generator size, battery chemical composition, and energy capacity to evaluate the least cost vehicle design that meets a certain performance index. Wang et al. proposed a multi-objective optimization algorithm based on stochastic search strategy for optimal design parameters of HEVs [39]. It has been found that the stochastic nature of the evolutionary algorithm can prevent convergence upon local sub-optima and is capable of seeking out the optimal solutions for multiple objectives in an efficient fashion. Whereas, Golbuff developed a novel methodology to optimize plug-in hybrid vehicle through minimizing powertrain cost to determine the optimum designs for AER of 10, 20, and 40 miles for a baseline vehicle platform resembling the characteristics of a mid-sized sedan [2]. All the optimal vehicle designs are determined through PSAT by simulating vehicle architecture utilizing MATLAB optimization routine to reduce fuel consumption and carbon emission. Shahi et al. optimized motor and engine sizes by meeting gradeability and acceleration constraints

while the battery size is determined to provide a certain AER based on minimizing the cost of the powertrain [31],[40].

All the above studies do not concurrently vary all the powertrain component sizes. Moreover, most of the preceding studies consider either a Series or Parallel architecture. In this thesis, PHEVs are optimized by varying all the powertrain component sizes concurrently and finding Pareto optimal combinations for desired objectives where the design has to meet certain energy and power requirements. However, the lifecycle cost is also a concern, and this provides the motivation for the study of optimal component sizing in all possible powertrain architecture. Optimal controllers for different objectives, such as GHG emissions, fuel and electricity cost are investigated in [41], [42]. Several references for algorithms that could be used for powertrain optimization are evaluated in [43]. Gao et al. [44] discuss different non-gradient algorithms and explains the pros and cons. Moreover, some studies are based on simple inventory and summation of up-front and recurring costs to assess costs associated with the lifetime of plug-in hybrid vehicles [45]–[49], while other studies are estimating longer future scenarios by assuming advancement in battery technology and manufacturing processes at scale to determine how costs will have evolved [18], [50].

2.2 Benefits of Vehicle Hybridization or Electrification

The hybridization of vehicle powertrain leads to several promising improvements in operational efficiency. First, the addition of powertrain electrification allows the engine to run at higher efficiency range with a greater amount of time. Usually, an internal combustion engine (ICE) operates at higher efficiency with a higher load near wide open throttle. While cruising and idling, the power requirements of a conventional vehicle

(CV) are small enough that the engine is being forced to operate at a lower load than the optimal. But, due to a hybrid powertrain configuration, the engine can operate most of the time at its maximum efficiency level, and utilized the surplus energy to re-charge the energy storage system. Whenever, the ESS are charged fully, then the motor can propel the vehicle by providing the small amount of power required while the engine remains completely off.

Moreover, due to the secondary power source such as an electric motor or battery as supplementary, it becomes possible to reduce the engine size. Typically, engines have high torque at higher rpm while electric motors are exactly opposite. However, using this principle, it's become more efficient to use the combined power of electric motor and engine than a large size equivalent torque engine to overcome torque or power requirements during either acceleration or climbing uphill. In addition, a small size engine minimizes the vehicle braking load, so that more energy can be recovered through the regenerative braking system.

Although, the secondary power source also allows the vehicle to shut completely off its engine instead of being idle. The electric motor can start the engine and move the vehicle simultaneously. By eliminating engine idling while sitting at a red traffic light considerably decreases fuel consumption in urban driving conditions. In addition, there are environmental benefits of powertrain hybridization. Typically, the engine/generator system (known as Genset) is operating at a predetermined and constant higher efficiency region where it would achieve lower fuel consumption per unit of output (the area of lowest BSFC) and produce minimal emissions. On the other hand, a PHEV gets its fuel economy benefits because of drivetrain electrification. But, the reduction of GHG

emissions only happen if the upstream emissions from the power plants are cleaner than the gasoline it is displacing [51]. Several studies [52]–[55] conducted regarding the PHEV integration into the grid, where all of them are proposed towards the application of renewable energy (such as: solar, wind vs. coal) during charging battery of either PHEV or EV in order to take the full benefits of vehicle powertrain electrification.

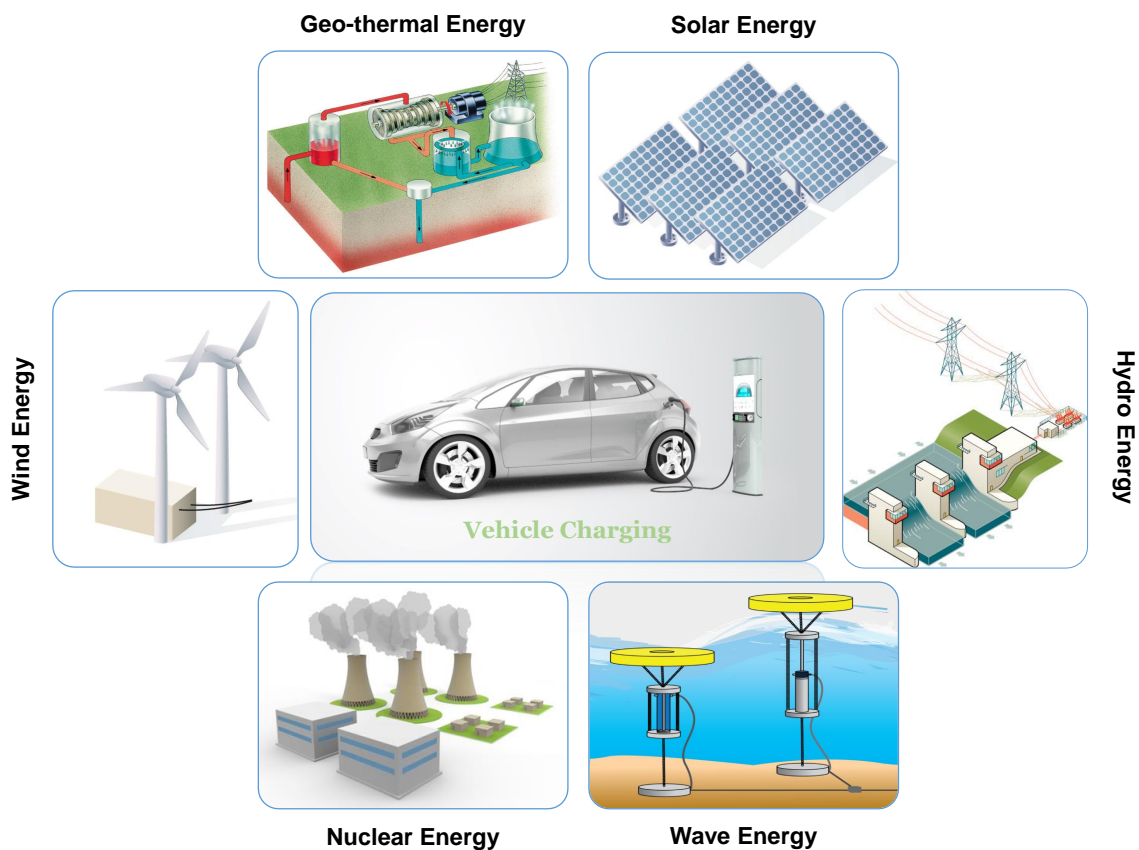

Figure 4 Application of renewable sources in vehicle charging

Finally, the powertrain electrification allows for regenerative braking. For a conventional vehicle, friction occurs in between wheel rotors and brake pads due to deceleration and all the kinetic energy generated due to braking or coasting are dissipated in the form of heat. But, with the assistance of electric motor, this energy can be recovered through

regenerative braking and is used to re-charge the battery pack. During this operation, the electric motor behaves like a generator. It has been found that up to 60% of the energy of braking can be recovered as useful energy by the regenerative braking system.

2.3 Degrees of Powertrain Electrification

It is convenient to distinguish the various levels of electrified vehicles currently at different stages of development. Depending on the degree of electrification, the electric powertrain architecture is classified into three broad groups.

Those are:

- (i) Hybrid Electric Vehicle (HEV)
- (ii) Plug-in Hybrid Electric Vehicle (PHEV)
- (iii) Electric Vehicle (EV)

In this section three types of vehicles described above generally, are extensively explained.

2.3.1 Hybrid Electric Vehicles (HEV)

A hybrid electric vehicle (HEV) is a form of vehicle that combines of a primary source of torque with its fuel source, one or more electric motor and a battery (also known as energy storage system). The primary source of torque is often a conventional engine, running on gasoline. Moreover, it may be an ICE powered by diesel, hydrogen or biofuel. The integration of electric powertrain is intended to achieve less fuel consumption and increased power than a typical CV or additional power source for electronic modules. However, it runs on fuel alone, and there is no existence of plug-in charging capability

for the battery but it has the ability to re-charge the battery through regenerative braking during coasting. Due to the powertrain hybridization, it can reduce fuel consumption so as GHG emissions. The Toyota Prius is the most popular and widely used HEV, with over 18 million cumulative units sold over the last 18 years [56].

A hybrid electric vehicle can operate in several modes. Figure 5 shows some of the typical operational modes of hybrid powertrain configurations.

- (a) **Electric Only:** during this mode, the engine is completely off, and only the battery provides required electrical energy to power electric motor. However, the electric only mode is only effective during idling and whenever the state of charge (SOC) of the battery is higher than a certain level.

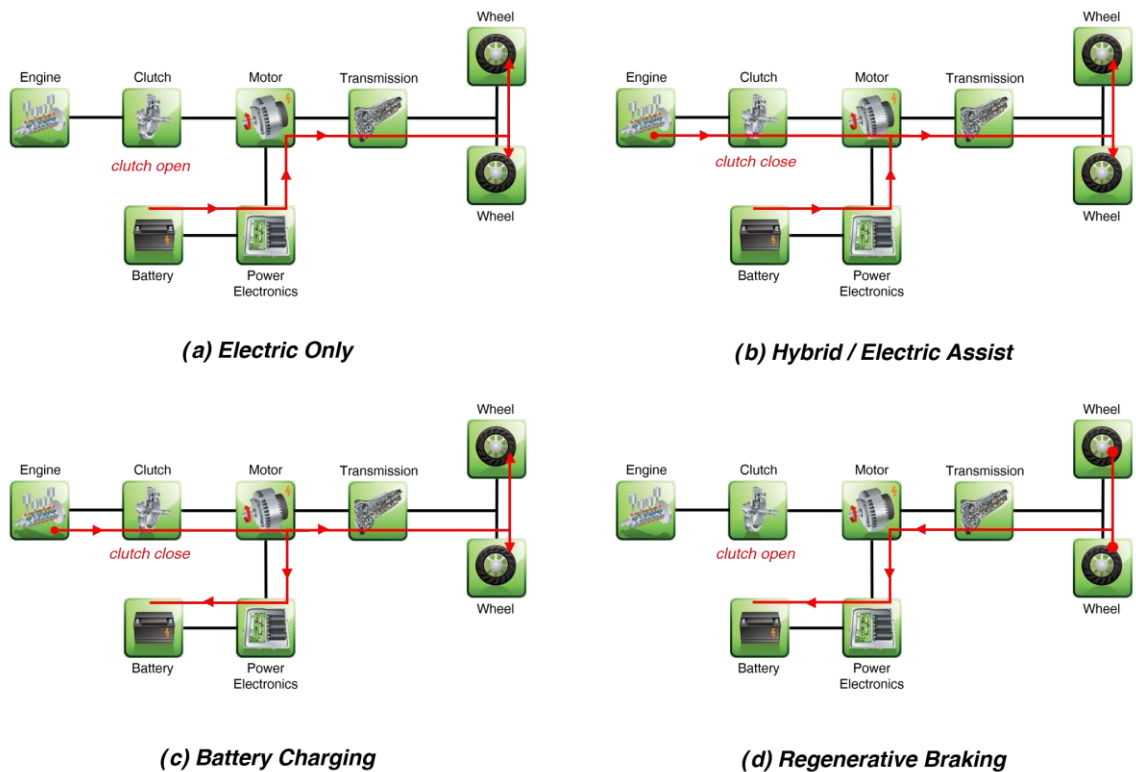

Figure 5 Operational modes of hybrid powertrain components

- (b) **Hybrid / Electric Assist:** whenever the engine alone fails to meet-up the required level of power demand due to the road condition, then the battery is turned on to provide a boost to the engine power through powering the electric motor.
- (c) **Battery Charging:** whenever the level of battery state of charge (SOC) becomes low and also during idling, the engine, and generator recharges the battery. Typically also powering the wheels; i.e. not just running a generator that would defeat the electrification savings
- (d) **Regenerative Braking:** the driving motor becomes a generator and recovers potential and kinetic (inertial) energies through its conversion to electric energy, a process which in turn is able to slow the vehicle and thus preventing wasteful transfer of this energy as thermal losses within the friction brakes [57].

2.3.2 Plug-in Hybrid Electric Vehicles

The new generation of the vehicle that are relatively new to the roads of Canada, and they are a unique approach by automakers in responding to more stringent greenhouse gas regulations are known as Plug-in Hybrid Electric Vehicles (PHEVs). They're commonly known for their instincts to respond to consumer demands for cleaner, quieter, technology when they're behind the wheel. Basically, a PHEV is having the similar kind of powertrain architecture like HEV but its most promising feature is the ability to re-charge the battery by plugging into the electric grid that consequently result in the necessity of higher battery capacity. Moreover, if the battery of a PHEV is not plugged-in to charge the battery then it would fail to perform at its maximum efficiency consequently fail to

reach its maximum driving range or optimal fuel economy scenario due to lack of battery charge.

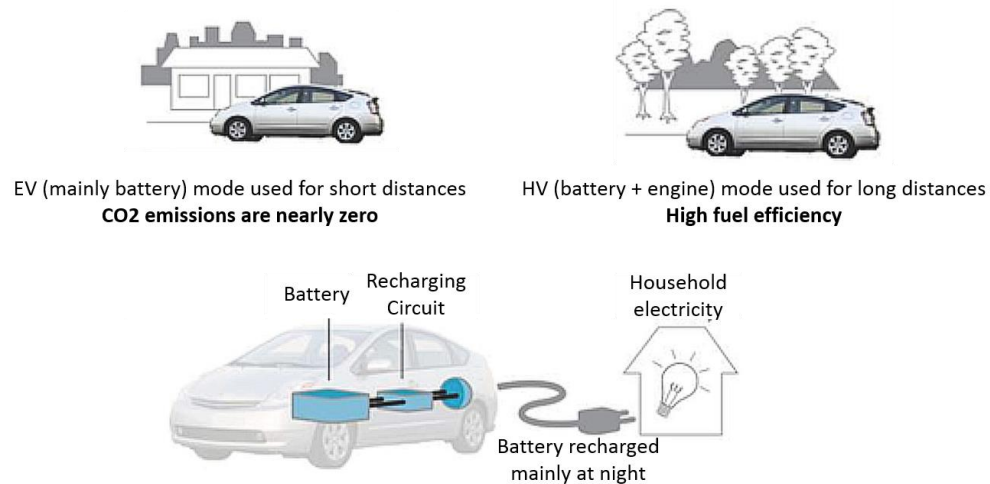

Figure 6 Aspects of Plug-in Hybrid Electric Vehicle (PHEV) [58] (Source: Toyota)

However, the operational cost of PHEV is lower than conventional vehicles because of lower electricity price. Since, its reducing dependability over gasoline, so as the emissions of greenhouse gas could be decreased but that totally depends on the place and at the time where the batteries are charged through the electric grid. Other advantages include a fewer number of fill-ups at the filling station, improved energy security and the convenience of home charging, opportunities to provide emergency backup power in the home, and vehicle-to-grid (V2G) applications. Currently, the Ford Fusion Energi, Toyota Prius Plug-in, BMW i3 range extender and Chevrolet Volt compete to be the best selling PHEV in the worldwide transportation market.

2.3.3 Electric Vehicles (EV)

Electric vehicles (EV), also known as pure battery electric vehicles (BEV) are driven only by an electric motor that draws electricity from on-board rechargeable energy

storage system. No other fuel source is used, and there is no internal combustion engine. Whenever, the batteries are running low, they must be plugged in to recharge. Otherwise, the battery will be degraded quickly.

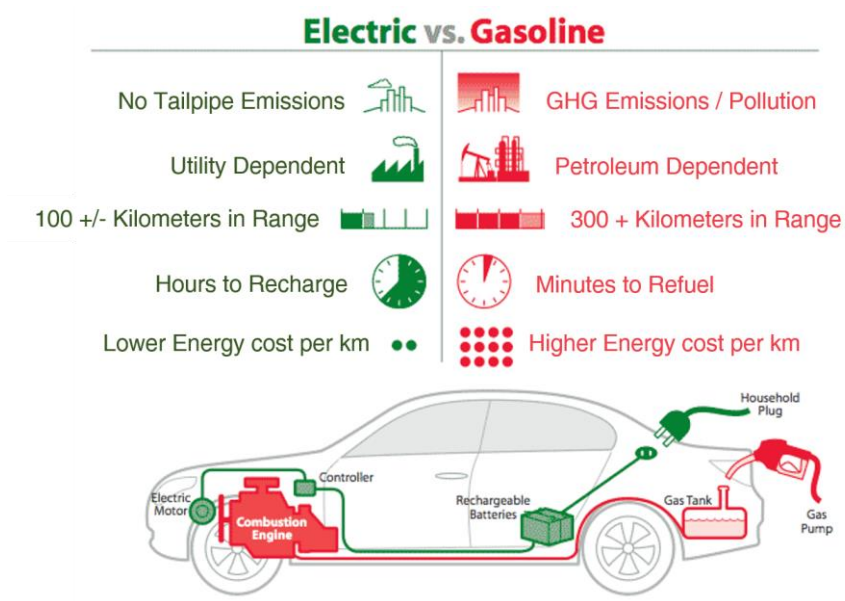

Figure 7 Various size of Electric Vehicles (EV) [59]

Furthermore, it is much more energy efficient as electric motor has the ability to convert energy with more than 75% efficiency whereas engine can do maximum up to 40%. Electric vehicles produce no tailpipe emissions, although the power generation plants producing the electricity may have emitted GHGs. Nissan Leaf, Tesla Model S, and Model X leads the worldwide electric vehicle market.

2.4 Hybrid Powertrain Architecture

There is few vehicle powertrain architecture exist as hybrid powertrain; those are series, parallel and split VPA. Another alternative is an entirely mechanical drivetrain where a flywheel is used instead of a battery, as energy storage device [60]. From now on, the focus is going to be in parallel, series and split hybridization because they are the three

most common powertrain architectures that are being in the development and studies so far.

2.4.1 Series Architecture

A series hybrid architecture uses the engine to drive the generator to produce electricity in order to supply charge to the battery. Then, the electrical energy from the battery is transferred to electric motor, which in turns drives the wheels to propel the vehicle. The advantage of series hybrid is whenever the battery is fully charged, the engine turns off and turns on again when the SOC is reached lower than a certain threshold. This process enables the engine to run at an optimum combination of torque and speed. Hence, no mechanical connection is needed between chassis and engine. Figure 8 illustrates the system configuration of a Series HEV. Also, the engine of the series hybrid system can be replaced by a fuel cell to convert it into a pure electric vehicle with zero emissions.

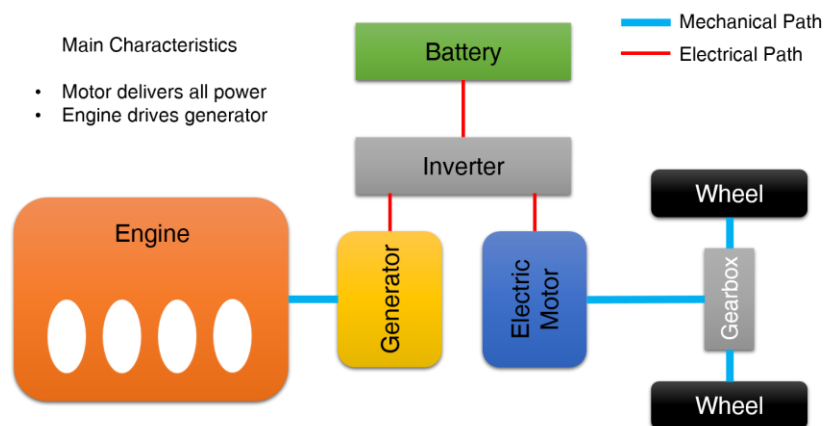

Figure 8 Series Hybrid Powertrain Architecture

The drawback of series hybrid system is the multiple level of energy conversions that are happened while transporting energy from the engine to wheels via the generator. During

energy transportation, a portion of energy is dissipated as a form of heat through each conversion due to friction and internal resistances. At the beginning of the hybrid vehicle revolution, most of the large automotive manufacturers focused preliminary on the potentiality of series hybrid architecture. Among those development, the most promising vehicle is BMW 3 series [60],[61]. Regardless of the early research and prototype development, the weight and cost of the vehicle is increased due to the necessity of two electric motors and large size internal combustion engine. The size of the power electronics unit is also excessive.

2.4.2 Parallel Architecture

The parallel hybrid architecture switches power sources between the internal combustion engine and the electric motor to operate in higher efficiency zone. Here, the vehicle can be driven by either engine, electric motor or even by the combination of both as they are mechanically connected to wheels. However, the control strategy can be developed in such a way that one can determine how the motor and engine is going to support each other to meet the required torque.

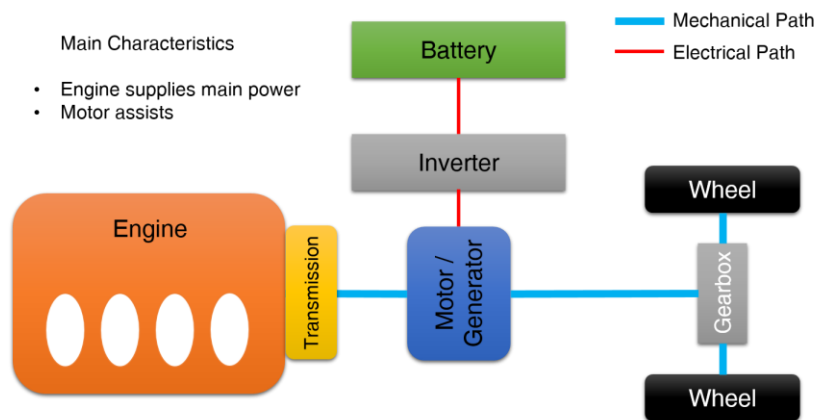

Figure 9 Parallel Hybrid Powertrain Architecture

As a result, both of the engine and the motors can be downsized, making the parallel architecture more appealing with lower costs and higher efficiency. Some early developments of parallel hybrid vehicles include the Daimler-Chrysler ESX 3, Fiat Multipla, etc. [62]. Depending on the driving condition, both power sources can also be used simultaneously to achieve the maximum power output. Figure 9 shows how the system configuration of a parallel PHEV works. The advantage of a parallel hybrid vehicle is that the system can offer higher efficiency during highway driving, as the vehicle speed does not vary significantly. The electric motor can be used reversely as like a generator to recharge the battery, therefore only the engine propels the vehicle. Although, the amount of energy loss is relatively smaller as there are fewer number of energy conversion. Typically, the electric driving mode is primarily used while driving in the urban condition to avoid the cold starts as it is mainly responsible for the higher level of emissions.

2.4.3 Split Architecture

In a split powertrain architecture, a vehicle can behave like a parallel, or series or even like a combination of both simultaneously due to the presence of power splitting device (PSD) which construct the mechanical bonding in between electric motors and the engine. The design depends upon the presence of two motors/generators and the connections between them (can be both electrical and mechanical). One of the most promising advantages of split architecture is the ability to decouple engine speed from the vehicle speed. This aspect is partially offset by the additional losses during conversion between mechanical power from the engine and electrical energy [63], [64]. A most well-

known configuration is the Toyota THS design that was first used on a Toyota Prius (illustrated in Figure 10).

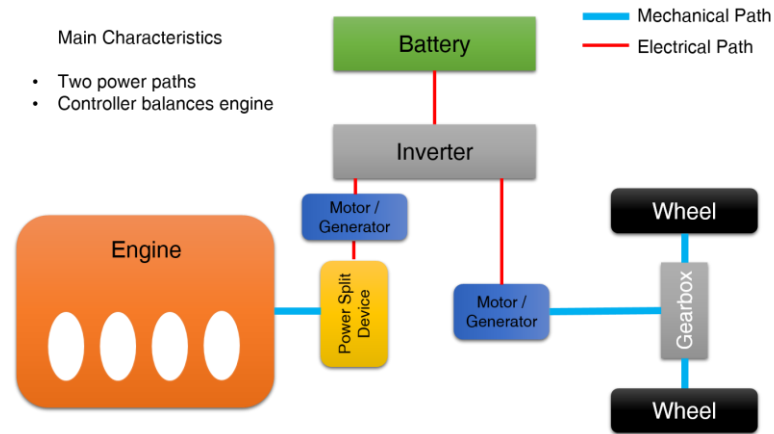

Figure 10 Split (Series – Parallel) Hybrid Powertrain Architecture

2.5 Technology Roadmaps of PHEV in the Market

Over the preceding few years, major automakers, and a few academic institutions have publicized their future plans in the development of PHEV models. There are already many mass-production of HEVs in the market, and PHEVs or EVs are getting consumer publicity or popularity in the global market day by day. Figure 11 shows the roadmap targets of hybrid, plug-in hybrid and electric vehicles up to 2050.

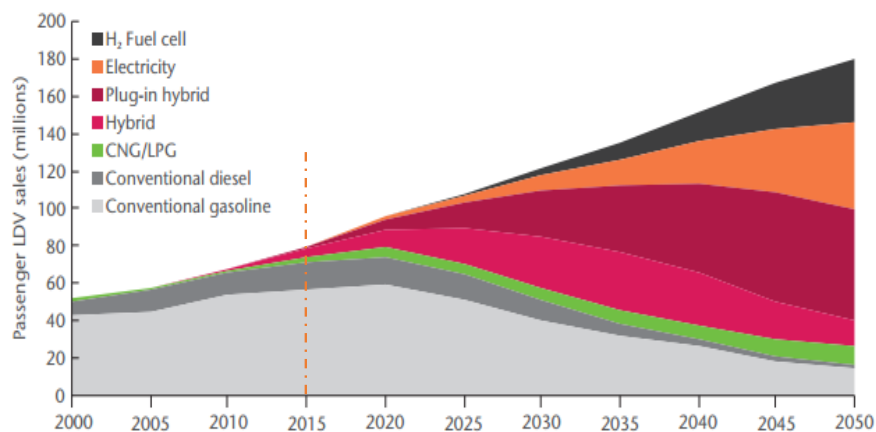

Figure 11 Annual light-duty vehicle sales by technology type [65]

Despite the recent revolution in the field of vehicle powertrain hybridization and electrification, this technology needs to overcome numerous barriers. The main barriers are the limitation in the all-electric range (AER) and high manufacturing cost due to the limitations of the prevailing battery chemistries [45].

To overcome all of these barriers, at first the technological advancement needs to be accomplished like material research for the chemical composition of batteries, development of more efficient control strategy, reducing vehicle weight, etc. However, the limitations of vehicle powertrain electrification are maintained since it was first introduced to propel a vehicle has proven challenging to overcome thus far, and the range anxiety of electric vehicles (both plug-in and fully electric models) that are now becoming accessible are being considered as interim or second-best solutions. But, the consumer needs to consider the desirability of these the potential technological alternatives, in terms of both the cost and emissions standpoint. Therefore, to reduce the volume of this study, the Fuel Cell Hybrid Electric Vehicle (FC-HEV) architectures are excluded, even though they may become more prevalent and can replace the IC engine if costs can be reduced enough.

Chapter 3: Vehicle Model Development and Simulation

Modeling and simulation are promising ways to develop a case study or research without spending time, workforce and money in constructing prototypes. However, there are a number of computer-based tools available for evaluating the influence of evolving technologies in regards of performance, efficiency, cost, and powertrain configurations of conventional, hybrid, plug-in hybrid, all-electric, fuel-cell hybrid and other alternative fuel vehicles.

In this study, ADVISOR has been utilized to carry over the technical analyzes of various powertrain combination to determine cost-effective solutions that simultaneously maximize energy savings and optimizing the component sizing of the baseline vehicle platform.

At first the significance of the computerized simulation model is discussed. Then, the details of baseline vehicle model are explained next. After that, the control and vehicle platform parameters are modeled using ADVISOR where the simulated model in ADVISOR being used as a black-box. The powertrain hybridization of baseline vehicle is optimized using multi-objective Pareto search optimization approach for the most efficient performance with respect to powertrain cost, operating cost, and fuel economy over two different established drive cycles, Urban Dynamometer Driving Schedule (UDDS) and Highway Fuel Economy Test (HWFET) drive cycle. These are representing city and highway driving conditions respectively. The vehicle modeling and simulation on ADVISOR for two different drive cycles, UDDS, and HWFET follows afterward.

3.1 Significance of Computerized Simulation Model

Since the design of PHEV is greatly depended upon the commercially available powertrain components, it is obvious to recognize these elements initially during the vehicle development stage. In addition, preliminary design calculations need to be performed with the available specifications supplied by the manufacturer. The outcomes of these calculations should indicate the level of acceptability of the designs, and also provide the hints if there are any necessities to make changes in component selections or design specifications. However, it is still uncertain about the design acceptability, and how they will react together as a single system. But, with a proper computer-based simulation tools, it is very much possible to evaluate whether the objectives are achievable or not under the certain design constraints and also suggest possible modifications that need to be done. This process of simulation is very prominent, flexible, and affordable than by constructing multiple physical prototypes and conducts trials over that. Due the level of complexity regarding modern world vehicles, the simulation tools are a quite advanced piece of software. Even though, there are a few publically available tools, which have been developed primarily by either government organizations or educational institutes; such as: PSAT, ADVISOR, FASTSim, GREET, Autonomie, which have been developed by US Department of Energy (DOE) at Argonne National Laboratory (ANL) or National Renewable Energy Laboratory (NREL).

In this study, ADVISOR is selected as vehicle powertrain simulation tool because of its numerous advantages. These include: (a) the steady state modeling nature makes it fast computational tool to perform parametric and sensitivity analysis; although unable to represent transient scenarios; (b) the combined backward-forward facing simulation

attributes allow it to simulate powertrain system more accurately; however the backward modeling approach is selected in order to faster calculation; (c) it is open-sourced and flexible enough to operate within MATLAB/SIMULINK environment; (d) it has component scaling and building functions which enable it for customizing components, vehicle configurations and control strategies [66].

3.2 Advanced Vehicle Simulator (ADVISOR)

The ADvanced VehIcle SimulatOR (ADVISOR) is developed in the mid 1990s by NREL but publically released in 1998 for analyzing vehicle powertrain in order to support US Department of Energy (DOE) in the technological development of hybrid electric vehicle through electrified drivetrain architecture by establishing agreements with Ford, General Motors, and Daimler Chrysler [67]. The primary objective is to provide the inter-component interactions of hybrid and electric vehicle powertrain components with their influences over the fuel economy and performance. The majority of ADVISOR users are either automakers or OEM component manufacturer while the rest of them are the members of academia or government entities. It is a model based system generated within the SIMULINK/ MATLAB environment where MATLAB is responsible for providing a convenient and flexible, yet robust matrix-based programming environment for performing complex mathematical analysis, while Simulink represents a sophisticated graphical system through block diagrams.

It has three key graphical user interface (GUI) windows to guide the application user either by GUI or without GUI through the simulation process. But, it becomes more flexible whenever it's being used without GUIs. However, the tool users able to determine the influences of various parameters (such as: vehicle attributes or control

strategy) and driving cycle requirements as a function of fuel consumptions, vehicle performance index or emissions through GUIs. The MATLAB workspace is used to provide inputs to a system and also represent all the outcomes from any system; however, this process is facilitated by the GUIs through the interactions in between input and output. The vehicle model is illustrated graphically through Simulink block diagrams to outline the interconnections among the components. During simulation, the vehicle model reads the inputs from the MATLAB workspace and outputs data as a result to the workspace in order to make it accessible. Finally, the actual vehicle model is composed of a combination of component models.

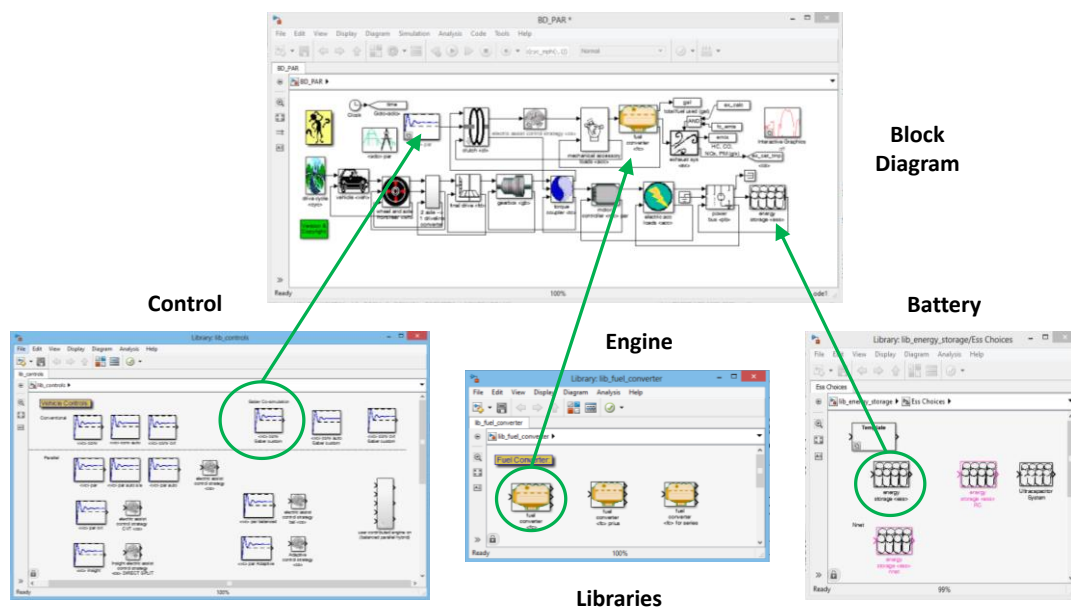

Figure 12 ADVISOR model definition employs linked library architecture [67]

ADVISOR employs an exclusive combination of forward and backward-facing simulation attributes. This behavior allows it to represent the operation of a vehicle accurately under a multitude of operating states without the doing any iteration, whereas it is mandatory for other models. A purely backward-facing approach propagates a high-

level requirement linearly backward through a series of systems; such as, it starts from a given driving cycle at the wheels, and traces back the needed power flow through the powertrain model to find out how much each involved component has to perform [28]. A control flow chart of a backward model is shown in Figure 13.

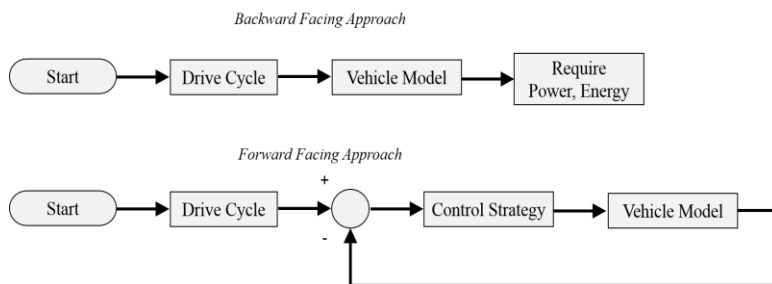

Figure 13 Flow chart of a backward, and forward facing modeling approach

In contrast, a forward-facing approach adjusts components individually and iteratively via control commands in various vehicle subsystems in order to determine the arrangement that diminishes the error between the actual response of the system and the driver demands to the control commands. Figure 14 shows the Simulink block diagram of a Toyota Prius plug-in model. The simplified function of this diagram is explained using the flow chart shown in Figure 13, as a so-called backward computer model.

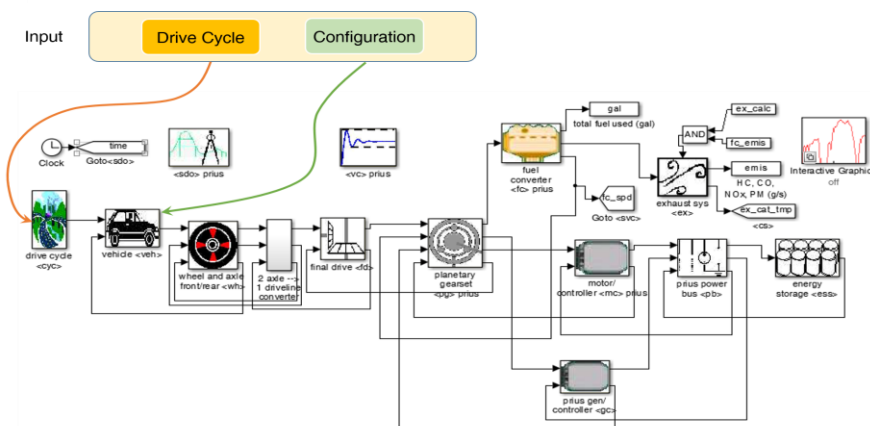

Figure 14 ADVISOR/Simulink block diagram of a Toyota Prius PHEV

However, the ADVISOR is still available as open sourced powertrain simulator (latest version: 2003), but with older components outside the validated Prius due to efforts shifting to proprietary software e.g. Autonomie and AVL (advanced vehicle dynamics simulator). Moreover, in order to establish similar kind of vehicle platform and control strategy, scaling functions are being used extensively.

3.3 Baseline Vehicle Platform

Currently, several models of PHEV are available on the market, and according to the sales data of light-duty vehicles this sector is getting popularity over conventional vehicles in the upcoming years. However, the Toyota Prius is the vehicle that actually brought public attention. That's why, this vehicle is considered for this study as the baseline platform to resemble a typical compact sedan.

Moreover, the baseline vehicle is validated in ADVISOR simulator (for details, see section 3.8). The following characteristics of the vehicle (mentioned in Table 1), taken from a 2012 Toyota Prius platform.

In this platform, it is a split architecture plug-in hybrid automobile equipped with a 1.8 liter SI gasoline engine with Atkinson cycle that is chosen as fuel power device. It has a 1.3 kWh 6 Ah rated Li-Ion battery with 25 modules that are used as the energy storage system by replacing the Nickel Metal Hydride (NiMH) battery package from original vehicle model. It consists one 75 kW electric motor and one 42 kW generator. The electric motor transforms energy from electrical to mechanical, and the generator transforms energy from fuel to electric.

Table 1 Basic parameters of the 2012 Toyota Prius PHEV [68]

| Powertrain Components | Description | Specifications |
|------------------------------|-------------------------------|-------------------------------|
| Engine | Size | 1.8 liter, 4 cylinder |
| | Power | Atkinson Cycle, 73 kW |
| | Efficiency | Gasoline 39% |
| | Torque | 142 Nm at 5200 rpm |
| Motor | Power | 75 kW |
| | Efficiency | Permanent Magnet 92% |
| | Torque | 272 Nm |
| Generator | Power | 42 kW |
| | Efficiency | Permanent Magnet 84% |
| | Torque | 272 Nm |
| Battery | Energy | 1.3 kWh |
| | Ah Rating | Lithium 6.5 Ah & 650 V max |
| | No of Module | Ion 25 |
| | No of Cell per Module | 3 cells (3.6 V each) |
| Vehicle Attributes | Description | Specifications |
| Vehicle | Coefficient of Drag | 0.25 |
| | Frontal Area | 2.081 sq. m |
| | Cargo Mass | 136 kg |
| | Net Power | 2012 100 kW (134 HP) |
| | Fuel Consumption | Toyota Prius 4.7 L/100 km |
| | Drive Control | Front Wheel Drive |
| | Electrical Accessory Load | 500 W |
| | Mechanical Accessory Load | 700 W |
| | Radius | 0.317 m |
| Wheel | First Coefficient of Rolling | Basic Model 0.007 |
| | Second Coefficient of Rolling | 0.00012 s/m |

Moreover, both the electric machines are permanent magnet categories and the engine is able to deliver its maximum power 73 kW at 5200 rpm whereas the electric motor delivers its maximum power output of 75 kW over the speed range of 4000-5200 rpm. As a result, the overall base vehicle mass is 1627 kg [69], [70]. Together, the engine and electric motor combination possess 100 kW as their max power output. While running condition, the 2012 Toyota Prius plug-in exhibits better fuel economy compared to

conventional vehicles. A model of Prius powertrain architecture is shown in Figure 15, and all the fundamental parameters are given in Table 1.

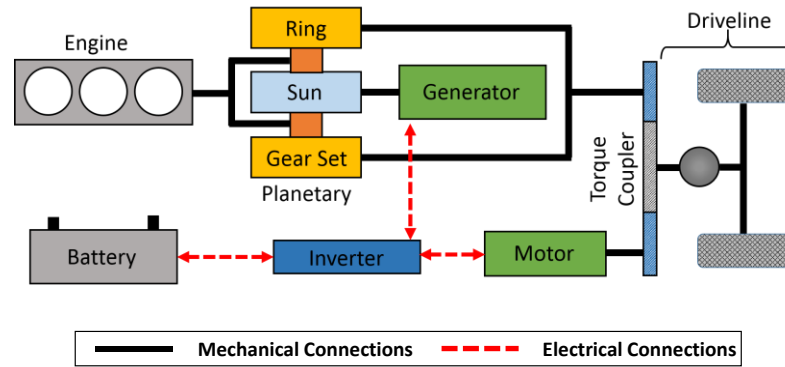

Figure 15 Structural design of baseline vehicle platform

The Toyota Prius uses a gasoline engine and an electric motor either separately or in combination to produce the most fuel-efficient performance. During vehicle start up or at low speeds, the vehicle is powered exclusively by an electric motor to avoid the least efficient and the most polluting operating conditions of an engine. This car also utilizes regenerative braking system with a better fuel economy of about 4.7 L/100 km compares to a typical conventional vehicle.

3.4 Powertrain Component Selection

The list of major powertrain components selected for modeling of baseline vehicle platform includes:

3.4.1 Internal Combustion Engine (ICE)

The engine converts the gasoline energy into mechanical energy to propel the vehicle wheels, and when needed, it operates the electric motor as like a generator to re-charge the energy storage device.

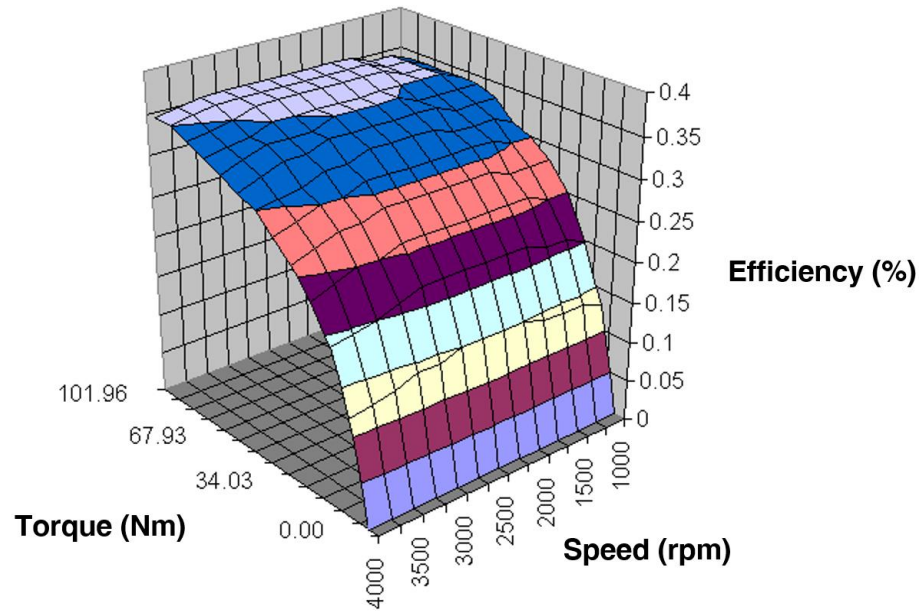

Figure 16 Toyota Prius engine efficiency map [71]

There are various types of engine designs available in the market so as in ADVISOR, but for this study, a scaled version of 1.8 L 73 kW spark ignition 2012 Toyota Prius engine is used. The relevant data for this engine is gathered from ANL and is shown in Figure 16.

3.4.2 Electric Motor and Generator

An electric motor is an electric machine that transforms electrical energy into mechanical energy. In case of Toyota Prius, these energy conversions happen in between battery pack and electric motor via continuously variable transmission, is also called CVT. While charging the battery pack, it transforms mechanical energy into electric energy through regenerative braking. There are two main types of electric motors used in PHEVs.

- (1) **Permanent Magnet Motors:** it needs magnetic field to produce power, and these magnetic fields are generated by permanent magnet

- (2) **Induction Motor:** it utilizes current to generate the magnetic field.

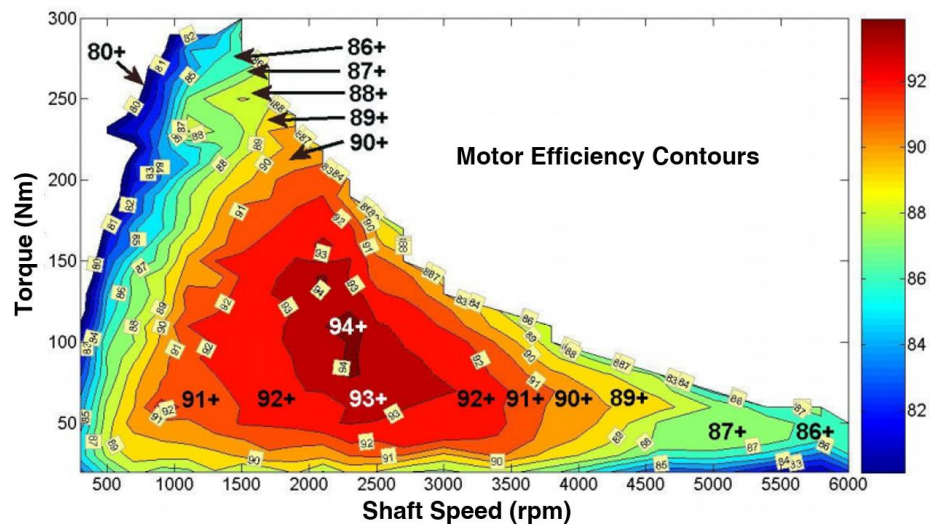

Figure 17 Motor/Generator efficiency map [72]

Figure 17 is illustrating the efficiency map of both the generator and electric motor. In this study, only the permanent magnet motors are investigated, which is commonly used in PHEV applications. A 75 kW permanent magnet electric motor is used during the optimization study. Whenever, the regenerative braking system is active, then the electric motor behaves like a generator by running in reverse mode. As like engine, these are also designed utilizing lookup tables, where the torques are indexed by the shaft speed. Moreover, a three-dimensional lookup table is used to generate the efficiency map where one axis belongs to shaft speed, and another one is a range of torque [73].

3.4.3 Energy Storage System (ESS)

The battery pack is also known as Energy Storage System (ESS); it is mainly used as an electrical energy storage device. Usually, the battery is made by a number of modules, and each module consists of a number of cells. Moreover, all of those modules are connected either in series or combined series-parallel to provide required voltage range

through summing up each cell's open circuit voltages. The range of voltage could be 100 to 600 volts depending upon the vehicle requirements. The battery packs can have various electrochemical compositions, but Lithium Ion (Li-Ion), Lead Acid (Pb Acid), and Nickel Metal Hydride (NiMH) are the most common ones. Hence, only the Li-Ion battery is considered for this study as nowadays it is the most widely used and one of the most efficient battery type in the automotive industry. The battery pack's energy capacity is usually given in Ah rating and its state of charge (SOC) is defined as:

$$SOC = \frac{C_{\max} - C_{\min}}{C_{\max}}$$

where, C_{\max} represents the nominal rated capacity of the battery pack in A-h and C_{\min} represents the capacity of the battery pack in A-h that has been used since the pack was fully charged. Typically, the safe operating range of SOC varies based on battery compositions but it is primarily forced to stay more than 0.2 as most of the battery pack begins to be damaged at an $SOC \leq 0.2$.

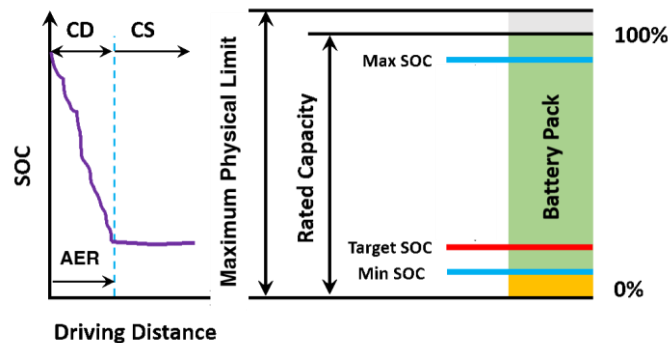

Figure 18 State of charge of a PHEV battery pack

Figure 17 illustrates a typical battery SOC curve which consists of two parts; (i) charge depleting (CD) represents the all-electric mode and (ii) charge sustaining (CS) represents

the conventional vehicle mode of a hybrid vehicle. The energy capacity of a battery is calculated by multiplying the rated capacity (6.5 Ah) and the rated voltage (266V) of the Toyota Prius battery. However, the ESS used in PHEVs are supposed to operate at a large state-of-charge (SOC) window.

3.5 Drive Cycles

A drive cycle (DC) is a series of collected data points representing the speed profile of a vehicle with respect to time. Typically, drive cycles are produced by different countries (like: US, Japan, European) and organizations (EPA, ANL, NREL) to assess the vehicle performances such as: fuel consumption, operating efficiency, and GHG emissions. Primarily, the fuel economy and emission tests are performed on chassis dynamometers. At first, the data of tailpipe emissions are gathered and then it is being measured to indicate the performance of the vehicle. Another use for driving cycles is used in propulsion system simulations to predict the performance of engines, electric motors, batteries, and similar components. However, the European Union derives drive cycles theoretically, while other directly measure the driving patterns through collecting fleet data. In this study, optimization is carried over the two different standard driving conditions: (a) UDDS and (b) HWFET.

In this study, UDDS and HWFET are selected because it's (a) standardized by EPA for any light-duty vehicle performance calculation (b) widely used to represent both city and highway driving conditions to evaluate vehicle driveability performances (c) mandatory in order to calculate "All Electric Range" of a PHEV or EV by both EPA and CARB. According to Appendix B, the level of aggressiveness belongs to mid categories (also UDDS is more aggressive driving cycles compared to HWFET in terms of acceleration

and deceleration) among the all established driving cycles that are available to represent different driving conditions including real-world scenarios. However, due to their wide application, these two drive cycles are being used for this research study.

3.5.1 Urban Dynamometer Driving Schedule (UDDS)

The full abbreviation of UDDS test is urban dynamometer driving schedule which is commonly called the LA-4 and refers to EPA authorized dynamometer test to determine consumption of fuel in order to represent city driving conditions with frequent stops that is utilized to test light-duty vehicle (such as: Sedan, SUV and Trucks). It is also used as a standard to evaluate exhaust emissions of a vehicle.

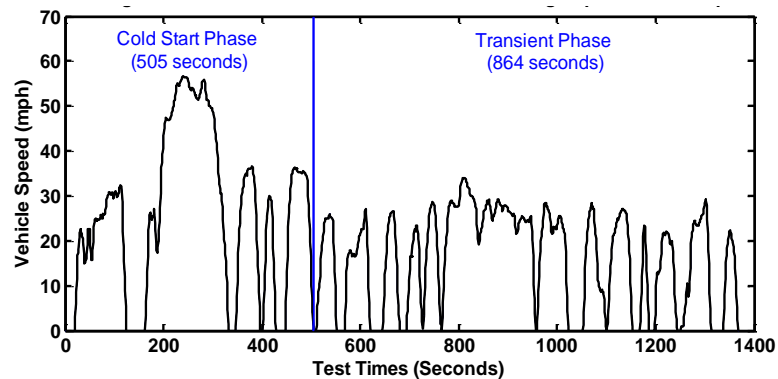

Figure 19 UDDS driving cycles

Moreover, a UDDS cycle has two separate phases: a cold start phase and a hot transient phase. The total drive cycle test time for the UDDS is 1369 sec, and the average speed is approx. 31.5 kph. The distance driven during the cycle is just about 12.1 km.

3.5.2 Highway Fuel Economy Test (HWFET)

The HWFET stands for Highway Fuel Economy Test. It is primarily utilized for simulating the highway driving conditions and estimating fuel economy associated with

highway driving. The EPA certified HWFET drive cycle test consists of a warm-up phase followed by a test phase. However, in ADVISOR the warm up phase is replaced by starting the vehicle with initial hot conditions. Over the 765 sec test time, the average speed is approx. 77.6 km/h over a 16.5 km driving distance [70].

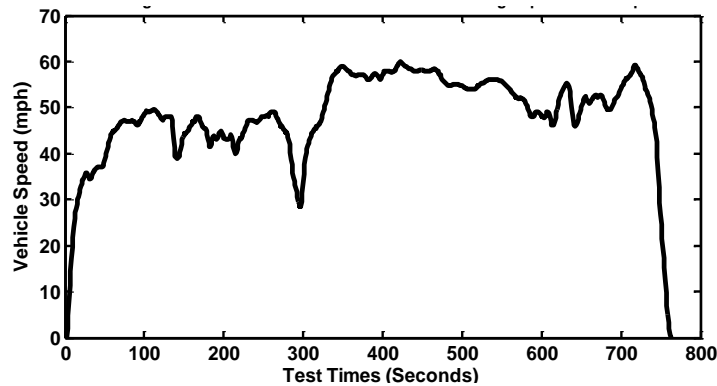

Figure 20 HWFET driving cycle

All the essential attributes of both drive cycles are mentioned in Table 2.

Table 2 General characteristics of drive cycles [70], [74]

| Attributes | UDDS | HWFET |
|--------------------------|-------------------------|-------------------------|
| Trip Type | City | Highway |
| Top Speed | 90 kph | 97 kph |
| Average Speed | 34 kph | 77.7 kph |
| Max Acceleration | 1.47 m/sec ² | 1.42 m/sec ² |
| Simulated Distance | 17.7 km | 16.6 km |
| Time | 31.2 min. | 12.75 min. |
| Stops | 23 | None |
| Idling Time | 18% of time | None |
| Engine Start-up | Cold | Warm |
| Vehicle Air-Conditioning | Off | Off |

3.6 Control Strategies (CS)

The adopted default control strategy of ADVISOR is rule based energy management approach that has two principal modes [75]. Those are:

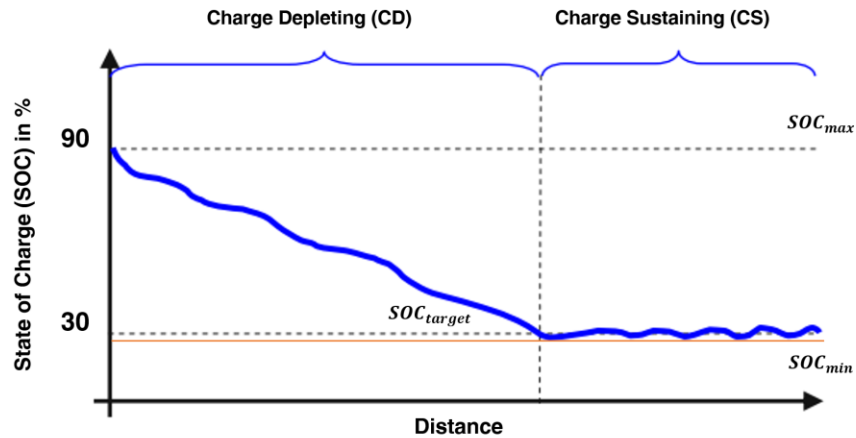

Figure 21 Control Strategy SOC Behaviour

- (a) **Charge-depleting (CD) Mode:** It is also called as an electric-only (EV) mode for a PHEV. Usually, it corresponds to the battery discharge from SOC_{MAX} (full-charged condition) to a SOC_{TARGET} (battery discharged condition), higher than SOC_{MIN} which covers 60% to 80% of total operational SOC window of a battery and known as "Swing". The electrical energy draws from either the grid or the engine are being used during the CD mode.
- (b) **Charge-sustaining (CS) Mode:** It is also known as conventional vehicle (CV) mode or PHEV0 control as during this mode, only the engine is active. It occurs whenever the level of SOC becomes too low and the battery unable to produce enough electrical energy to drive the vehicle. But, some energy can be recovered through regenerative braking and would be useful later on at certain conditions.

The most critical part of the control strategy logics belong to engine ON and OFF criteria. As Figure 22 demonstrates engine's ON and OFF logic that is categorized into following conditions [75], [76]:

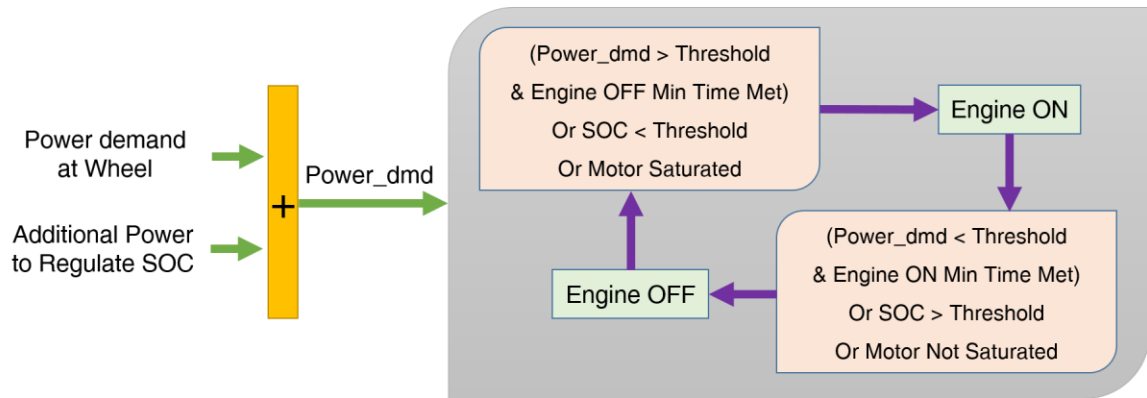

Figure 22 Simplified engine ON/OFF logic

(i) Engine ON conditions:

- a. If SOC of a battery goes down than the lower threshold of SOC and the requested power is positive
- b. If SOC of a battery goes higher than lower threshold of SOC, but the claimed power of the vehicle due to road conditions becomes greater than the maximum power rating of the electric motor

(ii) Engine OFF conditions:

- a. If requested power of the vehicle is negative, and the battery SOC is lower than its upper threshold
- b. If SOC of a battery goes higher than lower threshold of SOC, and the requested power of the vehicle is not only positive but also lower than the maximum power rating of the electric motor

In order to regulate the state of charge of energy storage system particularly during the CD mode, the requested power which is playing the key role in determining the ON/OFF conditions of internal combustion engine by summing up the requested power at the wheel and an additional power that depends on the state of charge of the battery. This

power could be negative or positive depending on the value of the current SOC compared to the target.

3.7 Utility Factors (UF)

As was earlier mentioned, a PHEV is fueled by gasoline and electricity. But, in order to represent the percentage of each ‘fuel’ type, the Society of Automotive Engineers (SAE) has established a method [77] to evaluate the weighting between conventional vehicle mode (gasoline usage or charge sustaining mode) and all-electric mode (electricity from stored energy derived from plugging into the grid or charge depleting mode). The calculation procedure utilizing utility factor is outlined in Figure 24.

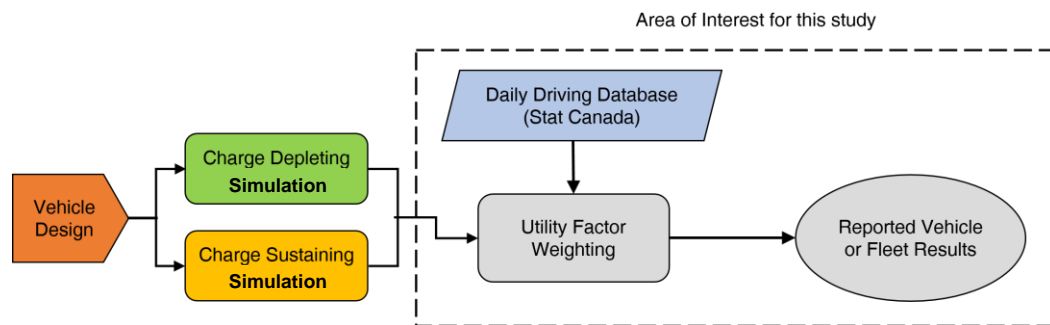

Figure 23 Utility factor calculation method [78]

Typically, Utility factor (UF) is % of population driving less km than a given range [79]. The UF for a particular distance d (in km), represents the cumulative percentage of that distance with respect to a total vehicle traveling distance within the distribution. To explain the scenario and Figure 24 more clearly, a classic example would be: if $d = 50$ km, then the UF would be approximately 60% which means the electric-only mode would cover up to 50 km by a PHEV x or EV x where $x =$ all-electric range = 50 km.

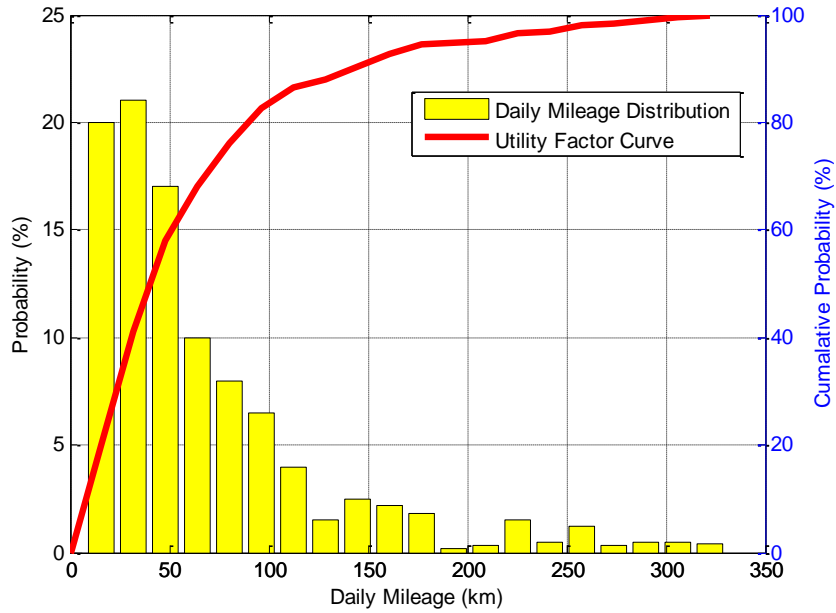

Figure 24 Utility Curve of Canadian fleet data for 150,000 user [80]

In this study, when overall calculating fuel consumption or fuel economy, the utility factor is directly used. For a single travel day (k) covering a distance (d_k), the daily distance UF of a PHEV can be calculated as the ratio of the charge-depleting range to the distance travelled

$\frac{D}{d_k}$ if $d_k < D$, and 1.0 if $d_k > D$. For N travel days, a composite UF

can be calculated as a function of D :

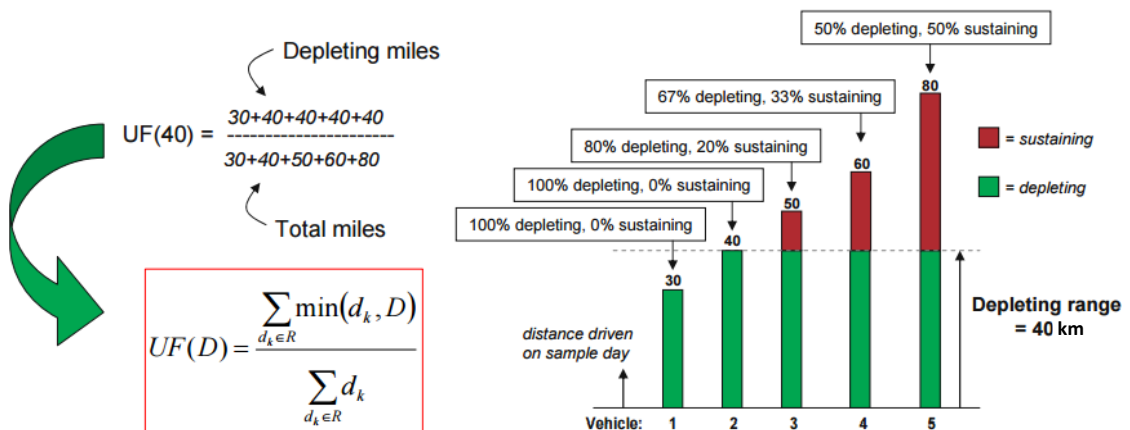

Figure 25 Explanation of Utility Factor (UF)

Moreover, the utility factor weighted fuel economy or fuel consumption of a PHEV fleet over a certain drive cycle can be calculated as:

$$FE_{UF-weighted} = \frac{1}{\frac{UF}{FE_{CD}} + \frac{1-UF}{FE_{CS}}} \quad \text{OR} \quad FC_{UF-weighted} = UF * FC_{CD} + (1-UF) * FC_{CS}$$

where $FE_{UF-weighted}$ and $FC_{UF-weighted}$ is the utility factor weighted fuel economy (100 km/L) and consumption (L/100km) respectively ; UF is the utility factor, FE_{CD} represents fuel economy during charge depleting mode and FE_{CS} represent fuel economy during charge sustaining mode.

Here, the UF data gathered from Stat Canada is integrated inside ADVISOR simulator to calculate a weighted fuel consumption that corresponds to distribution of national daily driving distances.

3.8 Simulation Model Validation

To ensure the simulation accuracy of ADVISOR, several validation studies have been accomplished since 1995 when it was first introduced by NREL. Primarily, the ADVISOR software comes validated with Toyota Prius, Honda Insight and GM Tahoe. Here, the validation examples are just described. The key foundation in a validation process involves the match-up of powertrain components operational conditions, such as the ON/OFF logic of engine, speed, and torque profiles of engine or motor.

Once the appropriate test conditions are established within the simulator, the values corresponding to electrical and fuel consumption should match the real-world test data in order to determine the simulator level of accuracy. The 2000 – 2005 Toyota Prius model

are already being validated based on the data gathered from Argonne National Lab (Vehicle and Engine), Idaho National Lab (re-chargeable batteries) and Ridge National Lab (Power Electronics and Electric Motors/Generators).

The Prius vehicle model has been validated over both the highway (HWFET) and urban (UDDS) drive cycles in [81]. However, only the urban driving cycle (UDDS) is presented in this thesis as these results found to be most deviated from actual data and would be proper representation of validation process. According to engine torque comparison between simulated and tested engine torque over UDDS are indicating good correlation. Moreover, high capacity battery power comparison in [81] illustrates a portion of UDDS cycle with respect to power variation of high-capacity battery. Note that the battery did not take part in the regenerative braking events.

Table 3 summarizes the key outcomes of this comparison study for both Charge Depleting and Charge Sustaining modes during city driving cycles. Both the electrical and gasoline consumption and SOC demonstrate good correlation compared to test-data.

Table 3 Validation Results – UDDS drive cycles during both CD and CS modes [81]

| During Charge Depleting (CD) Mode | | | | | |
|------------------------------------|----------|------|------------|----------------|----------------|
| Parameter | Units | Test | Simulation | Absolute Diff. | Relative Diff. |
| Fuel Consumption | L/100 km | 1.33 | 1.22 | 0.11 | 8.6% |
| Elec. Consumption | Wh/km | 86.3 | 83.8 | 2.5 | 2.9% |
| SOC Initial | % | 0.97 | 1 | 0.03 | 3.0% |
| SOC Final | % | 21 | 21.2 | 0.2 | 0.9% |
| During Charge Sustaining (CS) Mode | | | | | |
| Parameter | Units | Test | Simulation | Absolute Diff. | Relative Diff. |
| Fuel Consumption | L/100 km | 6.64 | 6.52 | 0.12 | 1.8% |
| SOC Initial | % | 21 | 21.2 | 0.2 | 0.9% |
| SOC Final | % | 20 | 19.9 | 0.1 | 0.5% |

Moreover, the energy usage of electrified drivetrain system (battery, power electronics and electric motor) to meet road load in all-electric mode (ZEV mode) is compared in between the Virginia Tech prototype vehicle and ADVISOR model which are mentioned in Table 4.

Table 4 All Electric Mode – Energy and Capacity Usage Validation [66]

| Drive Cycle | Actual | | ADVISOR | | Difference | |
|-------------|--------------|---------------|--------------|---------------|------------|--------------|
| | Energy (kWh) | Capacity (Ah) | Energy (kWh) | Capacity (Ah) | Energy (%) | Capacity (%) |
| FUDS | 2.63 | 8.2 | 2.63 | 8.1 | 0 | -1.2 |

Here the energy usage and capacity of the battery are compared which showed less than 2% variation in vehicle performance. In order to simulate hybrid vehicles (HEV, PHEV or EV) accurately through ADVISOR, this level of high accuracy is highly required in determining fuel consumption and GHG emissions.

3.9 Simulation Run

Figure 26 shows the powertrain simulation run window in ADVISOR. Here, two drive cycles are used over a specified vehicle configuration considering scaled engines, electric motors, and batteries through ADVISOR with different design parameters for modeling the performance of 2012 Toyota Prius. In US-EPA drive cycles, the initial sizing configuration of vehicle powertrain components (batteries, motors, and engines) are randomly selected in the simulation hybridization loop.

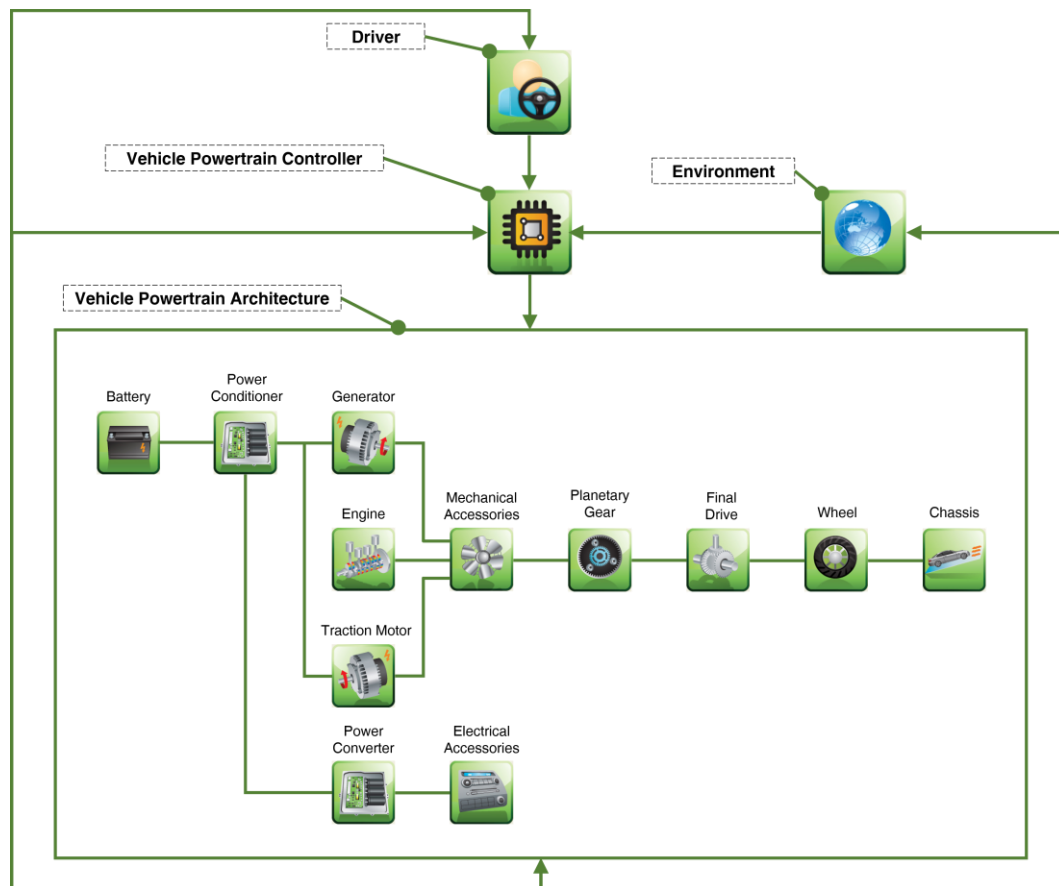

Figure 26 Interactive powertrain simulation window

Chapter 4: Cost Modeling

As PHEVs are gaining popularity in the world market after recent mass market introduction the cost associated with PHEVs is one of the vital factors in determining the consumer acceptability and the potentiality of this technologies for both the near and long-term future. Since most PHEV powertrains utilize emerging technology, tangible cost estimations are challenging to evaluate scientifically. To overcome this issue, the Hybrid Electric Vehicle Working Group (HEVWG) [35], Electric Power Research Institute (EPRI) and Argonne National Laboratory (ANL) [82] are working with automakers and other stockholders by publishing data based on their input. There are two different methodologies established by the WG to estimate the cost associated with vehicle powertrain components and lifecycle cost.

All the cost estimation includes manufacturing materials, the cost of labor and production volumes in considerations. Generally, these estimates are likely to occur by the year 2015 – 2020 assuming mass production. Here, all the component costs are projected for at least a volume of 100,000 units per years. Moreover, all the values were investigated using a Retail Price Equivalence (RPE) model starting with component cost and applying markup that covers both the manufacturer and dealers including development cost. In this chapter, the vehicle powertrain component costs, operating costs and total costs of ownership (TCO) are discussed in details. Moreover, the remainder of the vehicle costs are assumed fixed between powertrain designs.

4.1 Powertrain Component Cost Modeling

Typically, PHEVs are different in numerous ways than the conventional ICEVs. The powertrain components are one of them. A PHEV has a large battery pack, one or more electric motor (s) or generator (s), and a motor controller as part of propulsion system that are not present in an ICEV. Moreover, the internal combustion engine, transmission, climate controls, exhaust systems and even the emission control in a PHEV might be different from those in an ICEV due to the complexity of control strategies. In the following sections, we give emphasis only on the major powertrain component costs that are differentiate PHEVs from ICEVs.

4.1.1 Engine Cost

Typically, the engines are likely to be smaller in size for PHEV than for a CV. Here, the manufacturing cost of engine is collected from a study of EPRI [12],[83] and it is assumed to remain constant whether the OEMs manufacture the engines or purchased from suppliers.

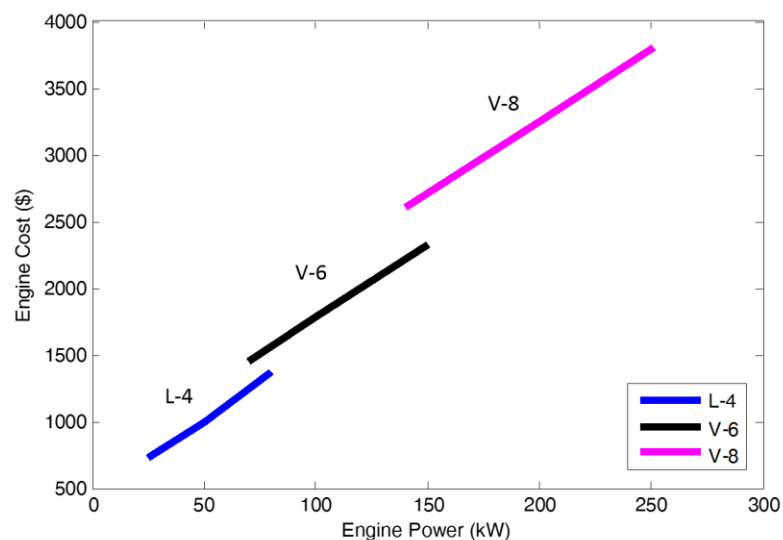

Figure 27 Engine cost as a function of engine power [83]

In Figure 27, engine costs are shown for L-4 (4 cylinders), V-6 (6 cylinders) and V-8 (8 cylinders) engines. However, only a 4 cylinder engine is considered for this study, to maintain the consistency with the ADVISOR simulation model. The cost of the engine C_{engine} is determined using the following formula that is generated based on Figure 27:

$$C_{engine} = 12 \times P_{engine} + 424 \quad (1)$$

where P_{engine} represents the maximum power of the engine in kW. This equation is valid only for an engine with 4 cylinders up to 90 kW as maximum power rating, after that the engine would become a V-6 (six cylinders) or V-8 (eight cylinders) with a different cost function.

4.1.2 Electric Motor Cost

The cost function of the electric motor also comes from the same EPRI research study [12]. This cost includes the cost of the electric motor, motor controller (also known as power-electronics), and a thermal management system. The following equation is used to calculate the cost of the motor, C_{motor} including power electronics:

$$C_{motor} = 21.775 \times P_{motor} + 425 \quad (2)$$

where C_{motor} is the cost of motor and P_{motor} is the maximum power rating of the electric motor in kW. However, this formula is only valid if the volume of manufacturing is at least 100,000 units per year and for a brushless permanent magnet electric motor. As earlier mentioned the cost of electric motor in equation 2 includes both the cost of the motor itself and the power electronics (as a PHEV requires an electronic controller in

order to control electric machines; such as electric motor/generator), here a typical pulse width modulation controller with thermal management system has been considered. The cost of this power-electronics, $C_{power-elec}$ and the motor, $C_{elec-motor}$ separately mentioned below:

$$C_{power-elec} = 8.075 \times P_{motor} + 235$$

$$C_{elec-motor} = 13.7 \times P_{motor} + 190$$

4.1.3 Battery Pack Cost

The cost of the energy storage system consists of the cost of the battery, hardware, mountings, and the thermal management system that is also known as a battery management system (BMS). There are several chemical compositions already available in the market as a rechargeable battery for hybrid vehicle technologies, and some are also in the development phase (shown in Figure 24).

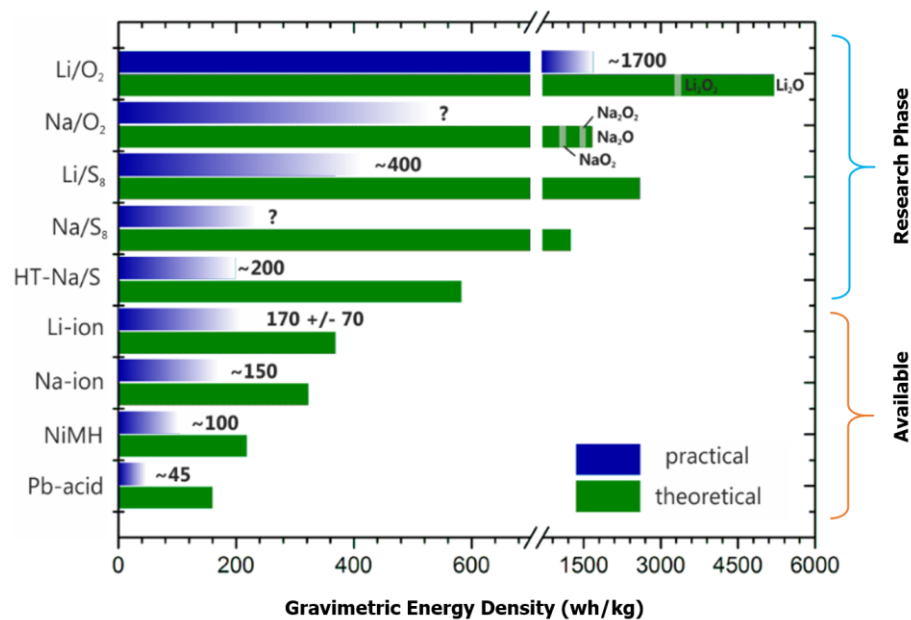

Figure 28 Theoretical and practical energy density of various batteries [84]

The Li-Ion composition is selected and a study of University of California Davis [85], [86] is used to estimate the cost of Li-Ion batteries, as it is the most promising battery technology so far and at the peak of development. However, the available cost function for hybrid vehicles is determined primarily based on small-scale consumer usage. This might be reduced substantially as production volumes increase and technology develops; this justifies the parameters studies later in section 6.2.2.

To determine the cost of Li-Ion batteries, the following equation is used:

$$C_{Batt,Li-Ion} = 651.2 \times E_{battery} + 680 \quad (3)$$

where $C_{Batt,Li-Ion}$ is the cost of the Li-Ion batteries and $E_{battery}$ is in kWh.

Furthermore, the energy of the battery is calculated using the following equation:

$$E_{battery} = \frac{V_{cell} N_{mod} N_{cell} C_{Ah}}{1000} \quad (4)$$

where V_{cell} is the voltage per unit cell, N_{mod} is the number of the module, N_{cell} is the number of cell per unit module and C_{Ah} is the Ah rating of the Li-Ion batteries.

4.2 Battery Replacement Cost

It is a very complex process to evaluate battery life as it's a function of numerous factors such as: charging cycles, discharging cycles, driving patterns, depths of discharge (DOD), climate conditions, composition of batteries, and even varies considerably among different battery pack designs. Moreover, it would be a very complex mathematical formulation to take account of all the factors in determining the lifetime of the battery.

Hence, in this study, to simplify the numerical model, only the influence of a fixed replacement time period is considered but no maintenance or incremental efficiency degradation of the components was included. Moreover, an equivalent vehicle driving mileage is taken into account rather than detailed battery charge-discharge cycle models. Based on review of the literature, an estimation of battery life considering the current level of technology for Li-Ion is approximately 1,200 cycles at DOD of 80% [83]. However, an EPRI study has also evaluated that 2,000 cycles on a PHEV20 roughly translates to 150,000 kilometers as vehicle mileage [87], [88].

The cost of battery replacement is assumed to be discounted with the economic present value equation:

$$BAT_{replacement} = \frac{C_{battery}}{(1+i)^N} \quad (5)$$

where $BAT_{replacement}$ is the present value cost (\$), $C_{battery}$ is the future value cost (\$) (from the battery cost equations), i is the discount rate, assumed to be 7% to estimate inflation, and N is the number of years when the battery is going to be replaced. Based on current battery technology, the lifetime of a battery is about 8 to 10 years [89], [90]. When determining total incremental powertrain cost or cost of ownership, the current cost of future battery replacement is included. However, only the battery cost is considered during future replacement, not the battery accessories.

4.3 Powertrain Cost

To simplify the vehicle powertrain cost model, the overall cost formula only considers the major powertrain component costs. Here, the major components are an internal combustion engine, electric motor/generator and battery pack. Moreover, it is assumed

that all the other components like vehicle chassis, structures transmissions, etc. remain the same as the baseline vehicle. The following equation gives the total powertrain cost of a vehicle:

$$C_{powertrain} = C_{engine} + C_{motor/generator} + C_{battery} \quad (6)$$

where C_{engine} is the cost of the engine, $C_{motor/generator}$ is the cost of motor / generator with power electronics, $C_{battery}$ is the cost of a battery pack including accessories and thermal management system.

4.4 Operational Cost

Typically, the operational costs evaluated including the cost of energy usage, maintenance costs, and battery replacement cost unless the nominal lifespan of the vehicle is less than the lifespan of the battery. In this study, only the cost of energy (gasoline, and in the case of PHEVs, both gasoline and electricity) and the cost of battery replacement are considered. However, two key aspects have to be compared consistently to determine the operating costs, namely: the nominal life of the vehicle and driving patterns.

The driving patterns (daily driving the distance, annual mileage) determine the amount of distance a CV or HEV drives annually and during its lifetime as well as the number of electric-only miles driven by PHEVs. To differentiate the driving range using electricity and gasoline fuel, the distances d_{CD} and d_{CS} traveled in Charge Depleting (CD) mode and Charge Sustaining (CS) mode respectively are needed. For a distance d traveled

between charges or on a daily basis in a vehicle with an all-electric range (AER) of d_{AER} , the distances d_{CD} and d_{CS} are calculated as following [17]:

$$d_{CD} = d \quad \text{If } d \leq d_{AER}$$

$$d_{CD} = d_{AER} \quad \text{If } d > d_{AER}$$

In this study, the fuel consumption (L/100km) and all-electric range (km) results are obtained from ADVISOR during simulation. Then, using the recharging cost of battery (\$/kWh) and gasoline fuel price (\$/L), the average operational cost, C_{op} is calculated as follows:

$$C_{op} = \frac{1}{d} \left(\frac{d_{CD}}{\eta_{CD}} \frac{C_{electricity}}{\eta_C} + \frac{d_{CS}}{\eta_{CS}} C_{gasoline} \right) \quad (7)$$

where η_{CD} is electrical efficiency (km/kWh) in charge depleting (CD mode) and η_{CS} is the fuel efficiency (km/L) in charge sustaining (CS mode) (both are also directly acquired from ADVISOR vehicle simulation results) η_C is the battery charging efficiency in percentage; $C_{electricity}$ represents the electricity cost; and $C_{gasoline}$ represents the gasoline cost; it is assumed that $C_{electricity} = 0.10$ \$/kWh, $C_{gasoline} = 1.3$ \$/litre based on the prices in Canada [91], [92], and $\eta_C = 90$ % [31].

4.5 Total Cost of Ownership (TCO)

Typically, the total cost of ownership (TCO) is comprised of numerous sub-costs; such as initial investment or vehicle purchase cost, yearly usage cost, maintenance cost, and salvage cost.

In this study, a simplified TCO model has been developed which includes:

- i. Powertrain Cost (Initial Investment)
- ii. Maintenance Cost¹
- iii. Energy Cost

$$TCO = C_{powertrain} + \sum_{i=1}^{n_{life}} D_{annual} \times C_{operational} + C_{replacement}$$

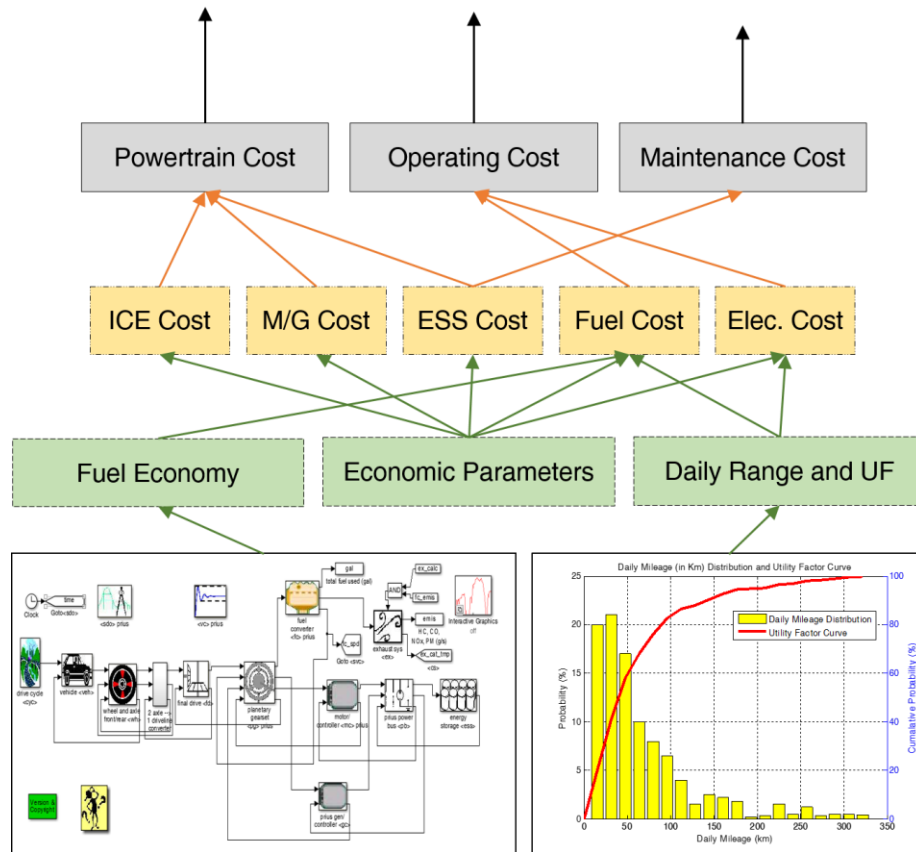

Figure 29 Total cost of ownership calculations

Here, the total cost of vehicle ownership is evaluated by the following equation:

$$TCO = C_{powertrain} + \sum_{i=1}^{n_{life}} D_{annual} \times C_{operating} + C_{batt-replc} \tag{8}$$

¹ Only battery replacements cost is considered as the part of the maintenance to reduce complexity

where n_{life} is the vehicle lifetime in year and D_{annual} is the annual mileage in km.

According to equation 7, the TCO is the function of following parameters:

$$TCO = f(C_{gas}, C_{elec}, I_{discount}, n_{life}, D_{annual}, C_{engine}, C_{motor}, C_{battery})$$

where $C_{gas}, C_{elec}, I_{discount}, n_{life}, D_{annual}, C_{engine}, C_{motor}, C_{battery}$ are gasoline price (\$/L), electricity price (\$/kWh), discount rate (%), vehicle lifetime (year), annual mileage (km), engine cost (\$/kW), motor cost (kW) and battery cost (\$/kWh) respectively.

Chapter 5: Methodology

5.1 Overview of Methodology

In order to evaluate the least energy consumption, operational and powertrain cost based PHEV design that meets a set of performance requirements, the following steps are used to carry out within a single optimization run:

- (1) Initialize MATLAB workspace and ADVISOR simulator to establish a link between both software
- (2) Define all the inputs associated with the problem formulation including vehicle platform with attributes, design variables (powertrain components) with boundaries, design constraints (including performance, and control parameters)
- (3) Define settings of optimizer such as optimization algorithm, population size, number of generations, and relevant characteristics
- (4) Run drive cycle test procedure over both charge depleting and sustaining mode in order to determine AER (for details, see Appendix A) during all-electric mode until it reaches to a particular battery SOC threshold and fuel economy during conventional vehicle mode (here, weighting of UF is applied to determine AER, see Section 3.7 at page 36)
- (5) Run gradeability test to determine the capability of a vehicle configuration to overcome a particular grade threshold

- (6) Compare the estimated vehicle performance with the pre-specified constraints (vehicle acceleration performance, maximum speed, grade, trace of drive cycle)
- (7) Calculate objective functions (powertrain cost, operational cost) if all the constraints are fulfilled otherwise neglect that particular vehicle configuration
- (8) Conduct optimization routine to generate Pareto front with optimized solutions
- (9) Post-process the outcomes that are the resultant of the simulation through optimization to plot specific relations or perform analysis such as breakeven point analysis, total cost of ownership and PHEV family optimization

5.2 Optimization Approach

The overall model is implemented with the combination of MATLAB and ADVISOR/SIMULINK analysis tools. A multi-objective optimization routine is also established to optimize the vehicle powertrain design in ADVISOR for a given driving patterns. The PHEV optimization model goes through several sub-system models to accomplish the optimization process. At first, a data input model collects an array of engine (ICE), motor (M/G) and battery (ESS) sizes based on specified upper and lower bounds. Then, a vehicle performance model evaluates powertrain components through scaling their sizes required to fulfill the performance prerequisites (such as acceleration, maximum speed, gradeability). After that, the generated powertrain configuration is used by a mass balance model to calculate the proper vehicle weight. The mass of each component is defined on the basis of its specific densities. In addition, the consumption of electricity and gasoline is determined with an energy consumption model by simulating the vehicle powertrain over the desired drive cycles. However, the energy and

performance models are coupled with the mass model to determine the mass compounding effect due to powertrain component sizing and then the vehicle cost model utilizes these data as input to evaluate the vehicle cost over the optimized configurations. Finally, the post processing performs calculations to account for the initial powertrain cost, energy consumptions, and operating expenses in a meaningful way and generates a Pareto front based on trade-off solutions.

5.2.1 Objective Functions

The PHEV optimization is a multi-objective research topic due to its complex and non-linear nature. In order to simplify the optimization process, it is assumed that all the components and associated accessories except major powertrain components (engine, motor, and battery) remain the same for all the vehicle designs. In addition, the research objective of this study is to evaluate the minimal operational and powertrain costs of the vehicle by focusing on direct comparison among various powertrain components. Here, the choices of powertrain components are expressed as the summation of the evaluated component costs associated with their sizes (see Equations 1 to 7):

$$f_1(x) = C_{powertrain} \quad (9)$$

$$f_2(x) = C_{operating} \quad (10)$$

5.2.2 Design Variables

The sizes of engines, electric motors, and batteries are considered to be the primary design variables for the PHEV optimization. A baseline vehicle platform is selected based on a 2012 Toyota Prius platform for the engine, battery (energy storage) and electric motor to consider the influences of the powertrain component sizing on the

optimization process. During component sizing, linear scaling of a power curve for individual powertrain components is taken into consideration along with the base model selection. Moreover, ADVISOR has a scaling function to size the component's nominal power, torque or other primary characteristics, as well as weight accordingly based on the scaling value [93], [94]. The scaling ranges of each design variables are shown in Table 5.

Table 5 Upper and lower bound of design variables

| Variables | Unit | Baseline | Lower Bound | Upper Bound |
|-----------------------|-------------|-----------------|--------------------|--------------------|
| Engine | kW | 43 (1.00) | 43 (1.00) | 129 (3.00) |
| Motor | kW | 75 (1.00) | 56 (0.75) | 150 (2.00) |
| Battery Module | # | 25 | 25 | 140 |

While scaling powertrain components, the key assumption regarding the linear scaling is that the torque/speed power loss maps (alike data as in efficiency maps) can be scaled by simply scaling the torque scale on the map. However, this is not the most precise scaling method, but was applied due to lack of an alternative available and reasonable scaling algorithm.

For example, if the value of the scaling function, S is selected as 0.5 for a component model, it means that the particular component is downscaled to 50 percent of its original size. Here, the size could be representative of power, energy, torque, etc. The torque scaling factor of the electric motor/generator ($S_{M/G}$) and the maximum power factor of the IC engine (S_{IC}) are used respectively for adjusting the motor and engine sizes. In order to size the energy storage system, module number (N_{BM}) of the individual battery

modules is varied during the optimization, and the battery module capacity remains constant at 20 Ah. However, in case of battery, power scaling is not considered as battery module primarily represented by its number of module and Ah capacity. Moreover, it is assumed that voltage change with number of modules can be handled by the power electronics.

5.2.3 Design Constraints

In this study, the optimized vehicle is required to meet at least three categories of performance constraints. Among those, some of them are taken directly from PNGV consortium, whereas additional constraints are developed from numerous consumer survey models [95], [96] established to represent consumer requirements while purchasing new vehicles. The driveability constraints are classified into the following (also shown in Figure 30):

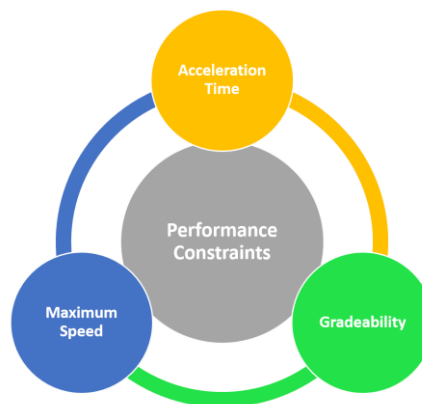

Figure 30 Driveability constraints

i. Acceleration Time:

- a. 0 – 97 kph acceleration time in less than 12 seconds
- b. 64 – 97 kph acceleration time in less than 5.3 seconds

c. 0 – 137 kph acceleration time less than 23.4 seconds

ii. Gradeability:

6.5% grade at 90 kph for 1200 seconds (during the gradeability test, the vehicle is allowed to engage both electric (motor/generator and battery) and mechanical (engine) power.

iii. Maximum Speed:

Top speed at least 145 kph

However, consumers could like to have many more drivability qualities in a single vehicle but if all of those constraints are integrated into the optimization routine, then it becomes significantly more complicated. Moreover, during optimization of PHEVs, each vehicle design must possess an all-electric range (AER) when in CD mode. In order to determine the AER, all the vehicle configurations need to start with SOC level at 100% and must be able to run the pre-specified number of drive cycles without utilizing mechanical power of the internal combustion engine until the battery SOC level reached 20%. Here, the final SOC is set to 0.2 to avoid rapid degradation of energy storage system from deep discharges [1].

In this research study, the engine, battery or electric motor/generator are sized in order to meet the drivability (acceleration, maximum speed and driving cycle load profile) requirements as well as the gradeability requirements.

5.2.4 Pareto Search Multi-Objective Optimization Algorithm

According to earlier sections, it is evident that the optimization algorithm needs to handle several design variables, constraints, and multiple objective functions simultaneously in order to optimize PHEVs. Moreover, the control strategy parameters and vehicle powertrain components are interlinked and also influential on the vehicle performance. The design objectives have conflicting and non-linear relations with design variables and constraints. Therefore, the PHEV optimization process needs to be formulated as a non-linear constrained multi-objective optimization problem.

Based on a literature review, very few optimization algorithms are applied in solving hybrid vehicle technology and these are mainly categorized into two groups:

- (i) Gradient-based (or derivative-based) methods
- (ii) Gradient-free (or derivative-free) methods

The classic example of gradient-based methods are Gauss-Newton, Steepest Descent and Sequential Quadratic Programming (SQP). The gradient method solves a problem utilizing derivative information [97], [98]. The key limitation of this optimization algorithm is that it requires well-structured assumptions to evaluate objective function like differentiability, or continuity. Moreover, these are also weak in determining a globally optimized solution.

In contrast, the gradient-free methods utilizes only the objective function or associated values and does not deal with any derivatives; i.e.: Nelder-Mead downhill simplex method [99], Particle Swarm Optimization (PSO) [61], [100], [101], Genetic Algorithm (GA) [102]–[107], Pareto Set Pursuing (PSP) [31] etc. Due to its derivative-free nature, it

becomes an effective solver for the hybrid vehicle design optimization problem. Although, these methods mostly allocate weights on each design objective and then aggregate all objectives to transform a multi-objective optimization into a single objective optimization problem.

The key disadvantage of this technique is that it generates only one solution after accomplishing the optimization process. To determine a different solution, one needs to restart the optimization process with a different formulation by either varying constraints priorities or by adjusting the coefficients associated with the weights. Moreover, the acquired Pareto solution is not necessarily convex or homogenous or consists of truly non-dominated solutions [108].

Most of these issues are solved if the objectives remain as multiple objective functions. That's why, in order to develop the multi-objective optimization, an elitist non-dominated sorting genetic algorithm (NSGA) [93], [109], [110] with Pareto front has been used. Typically, for any design problem having multiple objectives, it is entirely impossible to have a single solution simultaneously optimizing all the required objectives, particularly if those contradict each other. In many cases, improvement of one objective function may deteriorate another one due to the structure and inter-relation of objective functions. The focus needs to be put on the trade-off solutions in order to balance the objective functions whenever a perfect solution does not exist, and one objective function cannot be improved without worsening another objective function. These feasible solutions are known as Pareto-optimal or non-dominated solutions and are represented through a Pareto-front [109], [111] curve as in Figure 31.

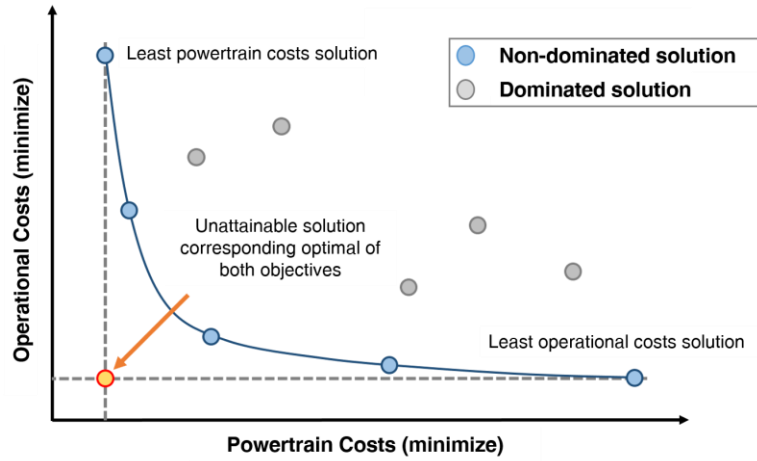

Figure 31 Pareto optimal solution searching technique

Suppose a vehicle needs to be designed with least cost. The least cost could be determined by reducing either operational or powertrain cost.

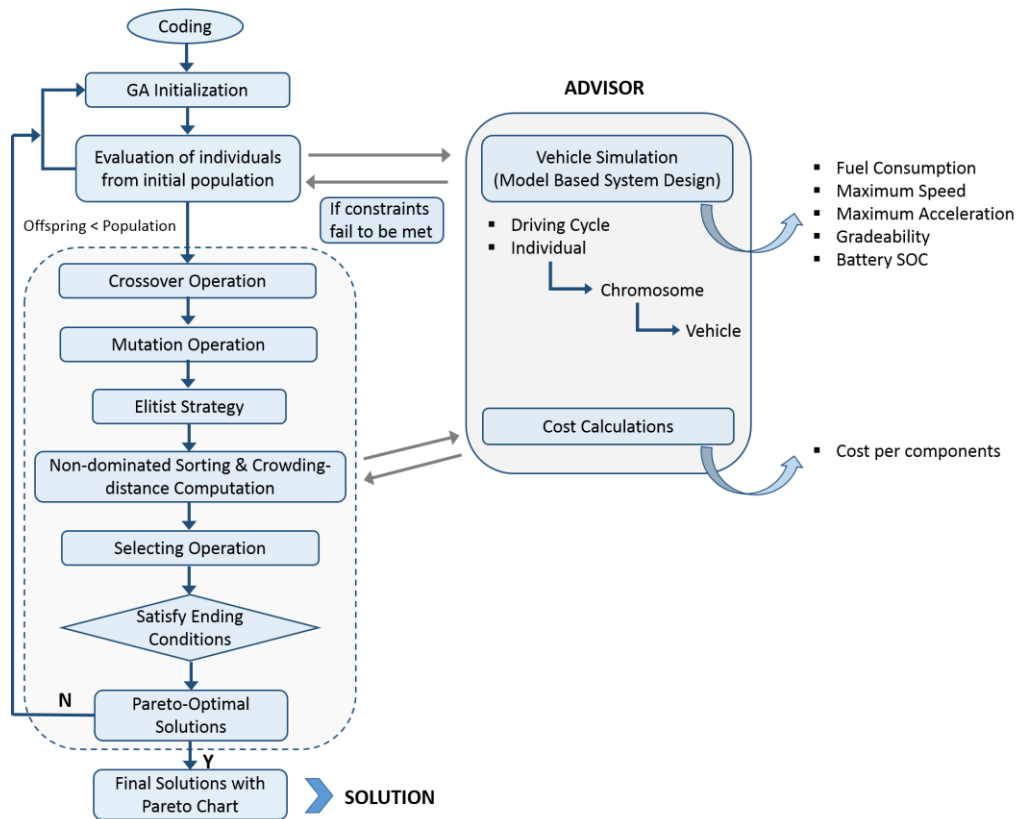

Figure 32 Iterative process of NSGA-II

The standard multi-objective optimization approach towards a problem of this type is to deal with each concern separately and then combine the results. The constrained integrated NSGA proposed in [111] is one of the first such evolutionary algorithms. The overall iterative process of NSGA is outlined in Figure 32.

Here, the Non-dominated sorting algorithm (NSGA-II) is used for this study because:

- a) Parameter optimization in PHEV/HEV is a non-linear constrained multi-objective research topic
- b) Design objectives are discontinuous, discrete and at the same time component models are non-differentiable

Moreover, other classical methods or other contemporary multi-objective evolutionary algorithm (MOEAs) have some limitations such as:

- a) Requiring strong assumptions (artificial fix-ups) for objective function so that appropriate weights associated with objectives can be specified
- b) Single solution for each objective optimization problem is obtained without any other information about trade-off among objectives
- c) Methods works on pre-defined rules and typically unable to evaluate global optimal solutions

The NSGA-II method outperforms these optimization techniques (PAES, SPEA, PSP) in terms of finding a diverse set of solutions and in converging near the Pareto-optimal set.

5.3 Linking of MATLAB Optimization Routine and ADVISOR Vehicle Model

Since ADVISOR is accessible without a GUI through other programs like MATLAB, the optimization routine is developed within MATLAB environment. Here, the MATLAB is used as an input window for initial vehicle configuration, objective functions, design variables and constraints. After getting all the required information, ADVISOR simulates the vehicle design process and returns the achieved data to MATLAB to cross-check with design constraints. The optimization algorithm alters the value of the fitness function parameters and then calculates them over the complete simulation tests (acceleration, drive cycle, and gradeability test).

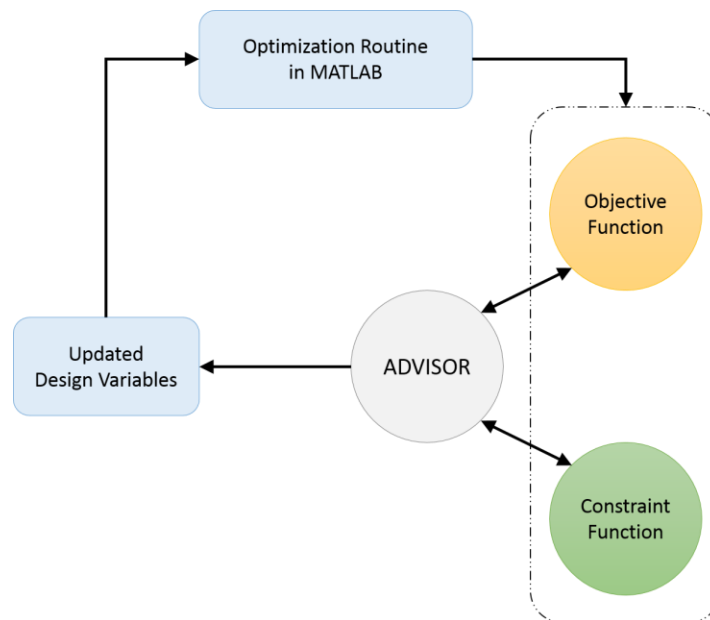

Figure 33 Linking of Optimization routine and ADVISOR vehicle model

The driving cycle test is employed to calculate the multi-objective function parameters, i.e., operating cost as function of energy consumption (both fuel and electricity), and powertrain cost as function of major powertrain components, while acceleration and

gradeability tests are employed for evaluating constraint functions. Figure 33 illustrates the integration of the optimization algorithm and the ADVISOR software. In our study, each optimization process takes up to 14 hours, and each vehicle drivetrain evaluation takes 30 – 40 seconds.

Chapter 6: Results and Discussion

This chapter aims to discuss briefly the findings of this research study that will be submitted for publication in appropriate journals. Therefore, results and discussion sections of all the papers have been reformatted to increase readability and to comply with the layout of the rest of thesis. The material in this chapter has been reformatted from the following paper drafts:

- **Paper 1** (*see section 6.1, page 59*):

E. Al Hanif and C. Crawford, '*Optimization of Hybrid Electric Vehicle Powertrain Components Considering Multiple Drive Cycles.*'

- **Paper 2** (*see section 6.2, page 72*):

E. Al Hanif and C. Crawford, '*Impact of Driving Cycles and Cost-parameters on Vehicle Lifecycle Costs in Optimized Plug-in Hybrid Electric Vehicles.*'

- **Paper 3** (*see section 6.3, page 96*):

E. Al Hanif and C. Crawford, '*Family Optimization of Plug-in Hybrid Electric Vehicles (PHEV) using Multi-objective Optimization Algorithm.*'

6.1 Paper 1 – Optimization of Hybrid Electric Vehicles

Paper 1 presents a methodology to evaluate HEV powertrain design using a multi-objective optimization algorithm with a built-in Pareto front pursuing technique. The preliminary focus is on the influence of driving patterns and analyzing the variation between urban (also known as frequent stop-and-go driving cycle) and highway driving scenarios in powertrain component sizing.

A trade-off study is conducted in terms of incremental powertrain cost and fuel economy. Moreover, the impacts of parameters associated with powertrain cost are individually investigated, and an in-depth sensitivity analysis is conducted in order to identify the significant parameters and the uncertainty of the powertrain cost modeling. Finally, it provides an outline of strategic vehicle development insights. The baseline vehicle for this study is the Toyota Prius detailed in section 3.3.

6.1.1 Effect of Driving Cycle on Component Sizing

In this study, the optimization process is carried over the urban (UDDS) as well as a highway (HWFET) driving cycles to assess the impact of driving cycles over the powertrain component sizing. At first, the hybrid vehicle powertrain design is optimized targeting reduction in the cost of the powertrain and fuel consumption. The obtained Pareto optimized solutions are compared among different powertrain architecture in Figure 34 (City driving condition) and Figure 35 (Highway driving condition).

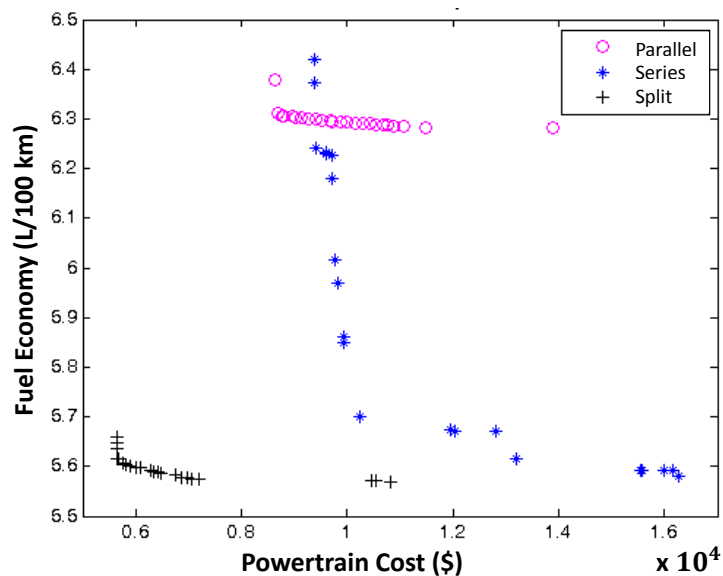

Figure 34 Pareto Solution of HEVs on City (UDDS) drive cycle

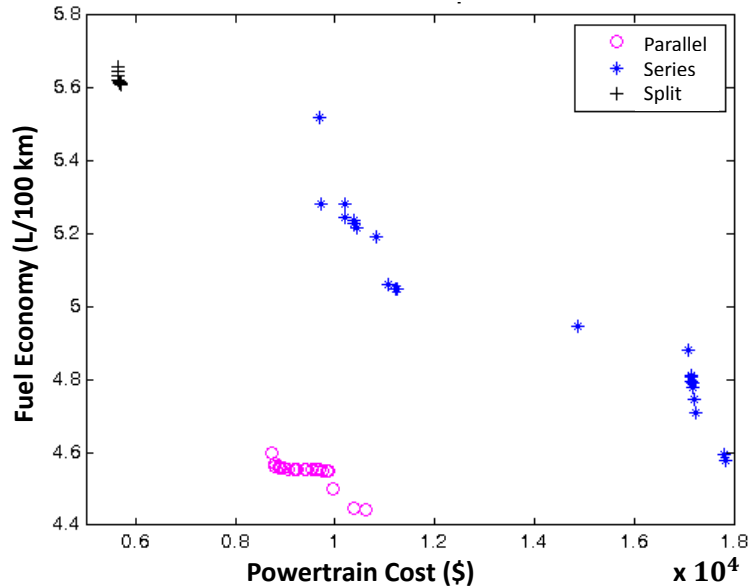

Figure 35 Pareto Solution of HEVs on Highway (HWFET) drive cycle

The optimized results do show better fuel economy relative to the standard conventional vehicle (UDDS – 7.79 L/100 km and HWFET – 5.04 L/100 km). It also shows that the power-split configuration is significantly worse for fuel economy compared to the parallel and series architectures in highway conditions (shown in Figure 35) as it is built for complex driving conditions like urban stop-and-go or city driving. Consequently, the Power-Split configuration obtains the best fuel economy for city driving conditions (shown in Figure 34).

On the other hand, Parallel configurations use comparatively smaller battery packs (shown in Figure 36 and Figure 37), since they depend more on regenerative braking and the engine can also operate as a generator for the recharging battery as a supplementary source; however, the regenerative braking process depends on the vehicle powertrain architecture. Moreover, as the internal combustion engine is directly connected with the wheels, the losses associated with converting mechanical power to electricity and back is

eliminated, consequently increasing the efficiency on the highway. Therefore, the efficiency and fuel economy are higher on the highway (best fuel economy in highway conditions) compared to city driving or frequent stop-and-go scenarios. Typically, in series configurations, the size of engine is comparatively smaller because it only needs to meet certain power requirements and reduced average requirement relative to the two other architectures. Both the electric motor and battery pack are more powerful (bigger power rating/size) than the parallel architecture in order to provide the full motive needs. This larger size along with generator, add to the vehicle's initial cost, making series powertrain more expensive than any other powertrain architecture.

In Figure 36 and Figure 37, the columns denotes the data mean over the designs making up the Pareto front, and the bars in the center denote the range over the Pareto population. Moreover, the HEV powertrain cost (gasoline engine plus motor controller and battery pack) is significantly higher than the reference conventional gasoline-driven vehicle in terms of powertrain cost, especially due to the battery cost for vehicle hybridization.

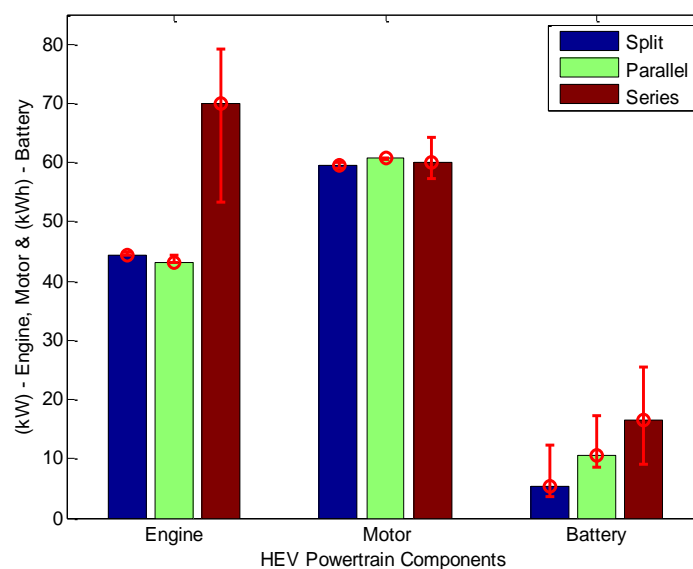

Figure 36 Pareto Optimized solution over UDDS driving conditions

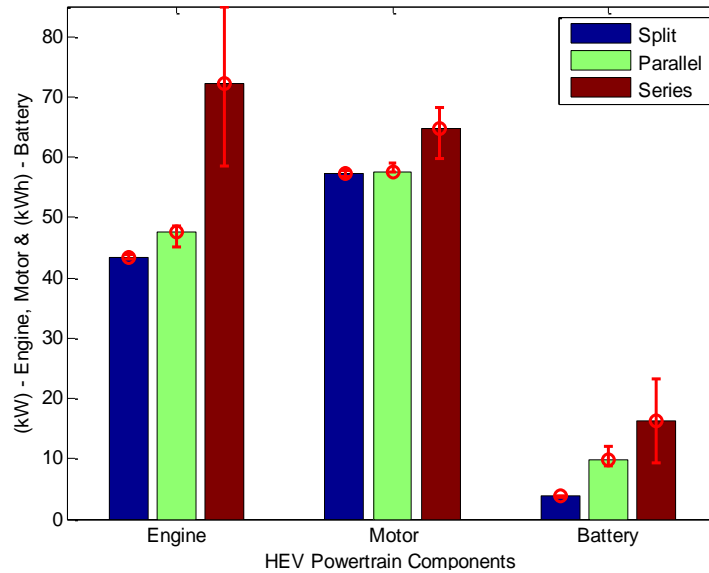

Figure 37 Pareto Optimized solution over HWFET driving conditions

According to Figure 36 and Figure 37, the power of the engine and motor (kW), and the energy of battery (kWh) increases as the aggressiveness (see Appendix B) of driving cycles are increased. Consequently, higher powertrain cost and vehicle mass is acquired. As an example, the Series HEV is expected to be more costly than the Parallel HEV, due to the presence of larger size of battery and electric motor.

Furthermore, Figure 38 and Figure 39 illustrates that all the HEV key powertrain combinations derived from the Pareto optimized solution are able to achieve several key performance improvements comparatively to the reference vehicles (0-96.5 kph \approx 15.2 sec, 64.5-96.5 kph \approx 7.2 sec and 0-136.8 kph \approx 30.4 sec)² with the standard HEV control strategy ($\Delta\text{trace}_{\text{drive-cycle}} \leq 2\%$ and $\Delta\text{SOC} \leq 0.5\%$). Here, the green lines are separating data associated with the different level of acceleration performances³.

² Reference vehicle data are generated from a CV based on 2012 Toyota Prius Platform.

³ Acceleration performances are collected from PNGV standards (see Section 5.2.3, Page 52)

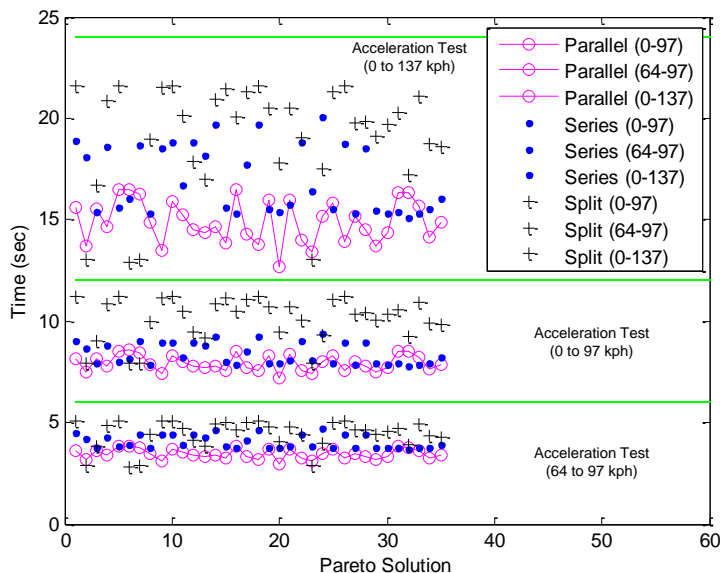

Figure 38 Vehicle acceleration performance on UDDS driving condition

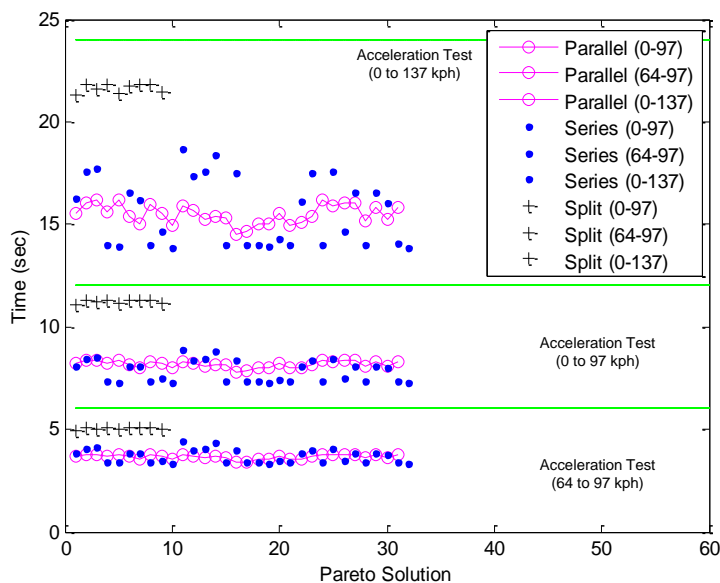

Figure 39 Vehicle acceleration performance on HWFET driving condition

The control strategy is highly dependent on the components and their combination in the powertrain. Further analysis indicates that maintaining the gasoline fuel cost, a “trade-off cost” of gasoline fuel exists from which the optimized HEV vehicle is no longer compensatory relatively to the conventional gasoline vehicle. Each driving cycle is

associated with a “trade-off cost” of gasoline fuel since the fuel consumption is not the same for each different driving cycle.

6.1.2 HEV Powertrain Optimization: Single vs. Multiple Driving Cycle

Hybrid vehicle drivetrain sizing to meet vehicle requirements on drive cycles other than those used for powertrain component optimization needs to be determined. To evaluate the effect of additional drive cycles on the optimized vehicle powertrain combinations, the optimization procedure is conducted over City (UDDS), Highway (HWFET) and combined City and Highway separately.

All the possible powertrain combinations based on one driving cycle’s Pareto solution set are analyzed over the other drive cycles after conducting the optimization routines over all of these driving cycles. It has been found that all the Pareto solutions based on only city driving conditions cannot fulfill all the performance constraints if these combinations are operated on the highway driving cycle.

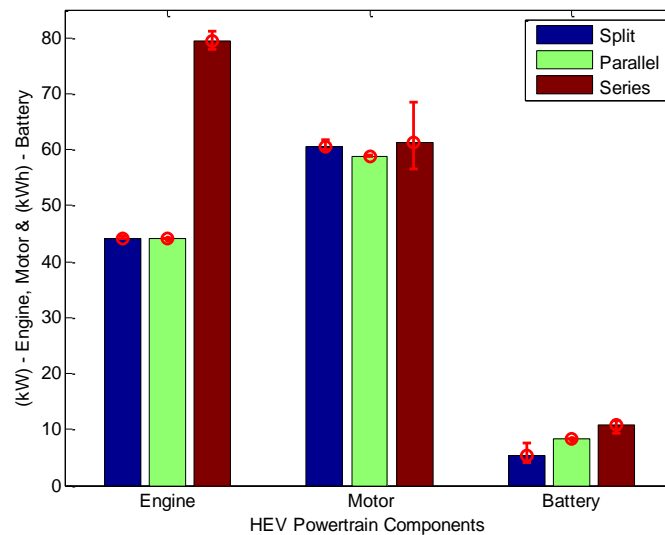

Figure 40 Pareto Optimized solution over City + Hwy driving conditions

However, if these Pareto solutions are obtained from combined city and highway driving conditions, then they can fulfill either city or highway driving condition separately. According to Figure 36, Figure 37 and Figure 40, the resultant Pareto solutions are lower in specifications such as engine, motor and battery sizes (kW or kWh).

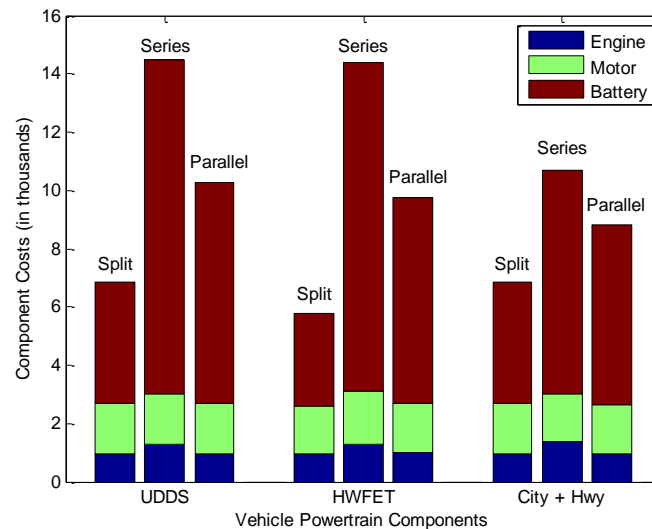

Figure 41 Powertrain Costs distribution among components (Nominal)

In Figure 41, component-based cost distribution is shown indicating that the battery system contributes the major portion of HEV powertrain cost, and the engine is a least costly component. There is also a noticeable shift in costs when optimizing over combined City and Highway for the series and parallel architectures as these two configuration performs better in either highway or city driving conditions; whereas, split VPA performs well in any sort of driving cycles due to their dual (series and parallel) nature.

6.1.3 Effect of Sensitivity Analysis on Powertrain Cost

Since the component costs are variables that are far from being precise and stationary, a sensitivity analysis was performed based on Eqn. 10. It represents a comparison between

powertrain components of the optimized HEV vehicle relative to various powertrain architecture. Note that negative values represent savings.

For further evaluation of net cost effects over various powertrain components, the powertrain cost is calculated by considering major powertrain components. The cost effect of the base vehicle cost ($C_{VEH} = \$17,600$ based on 2012 Toyota Prius platform) is excluded. The parameters associated with the baseline scenario are listed in the rightmost column of Table 6.

Table 6 Parameter levels for sensitivity analyses

| Sensitivity Analysis Parameter | Unit | High Level | Low Level | Base Level |
|---------------------------------------|-------------|-------------------|------------------|-------------------|
| - | - | 20% | 10% | 0% |
| Engine Cost | \$/kW | 9.5 | 10.8 | 12 |
| Motor Cost | \$/kW | 17.5 | 19.5 | 21.8 |
| Battery Cost | \$/kWh | 521 | 586 | 651 |

Several level of sensitivity analyses were carried out as listed in Table 5, and the results are shown in Figure 42 and Figure 43; the circle (o) represents nominal powertrain costs and ranges are from the Pareto points (optimized population of corresponding scenarios).

It is clearly observed that the rank among the HEV powertrain architecture costs is: Split > Parallel > Series either on UDDS (city) or HWFET (highway). We found that increasing or decreasing engine manufacturing cost does not alter the rank of HEV powertrain cost competitiveness due to the Series HEV's high battery costs and superior performance in stop and go situations by the Split HEVs over the city driving condition (UDDS). Similar results were observed for cost reductions in the electric motor and generator system and the rank among the HEV powertrain architectures remained the same (Split > Parallel > Series). Lower battery prices (e.g. 10% reduction) make Series

HEVs only slightly more cost competitive, but high price reductions above 20% make Series HEVs one of the better ranking low-cost option. In that case the rank among the various HEV powertrain architecture became: Split > Series > Parallel over the city driving conditions.

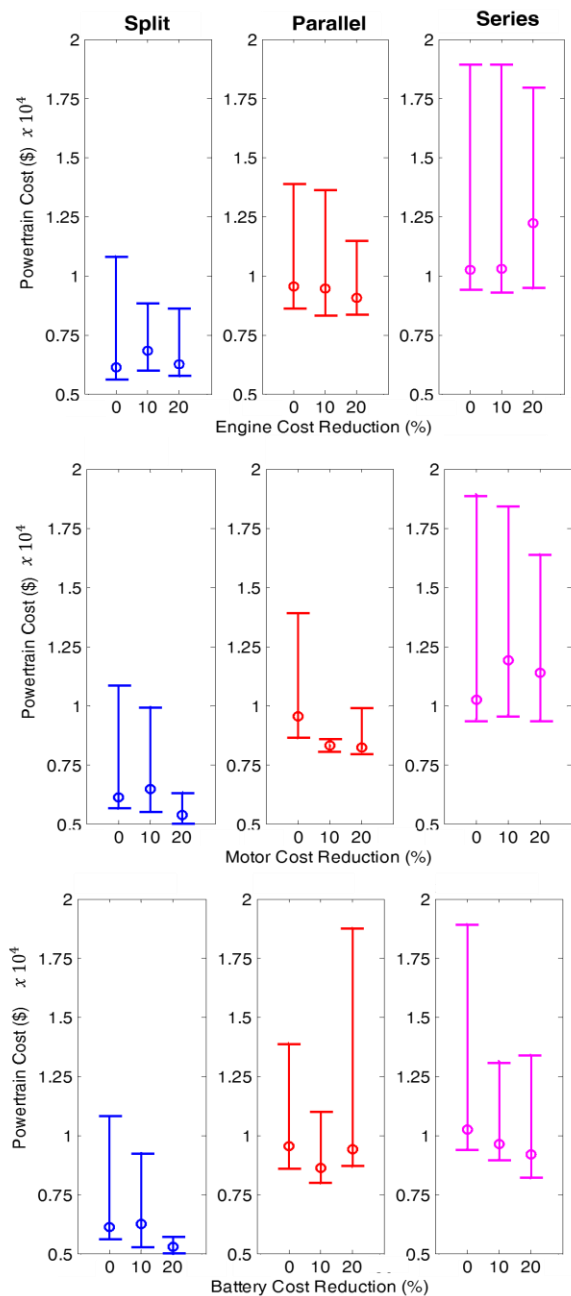

Figure 42 Sensitivity Analysis over UDDS drive cycle

On the highway driving pattern HWFET, if there is small (10%) price reduction of the engine, there is no change in competitiveness among the powertrain architecture of HEVs as Parallel HEVs usually use smaller battery packs, since they depends more on regenerative braking.

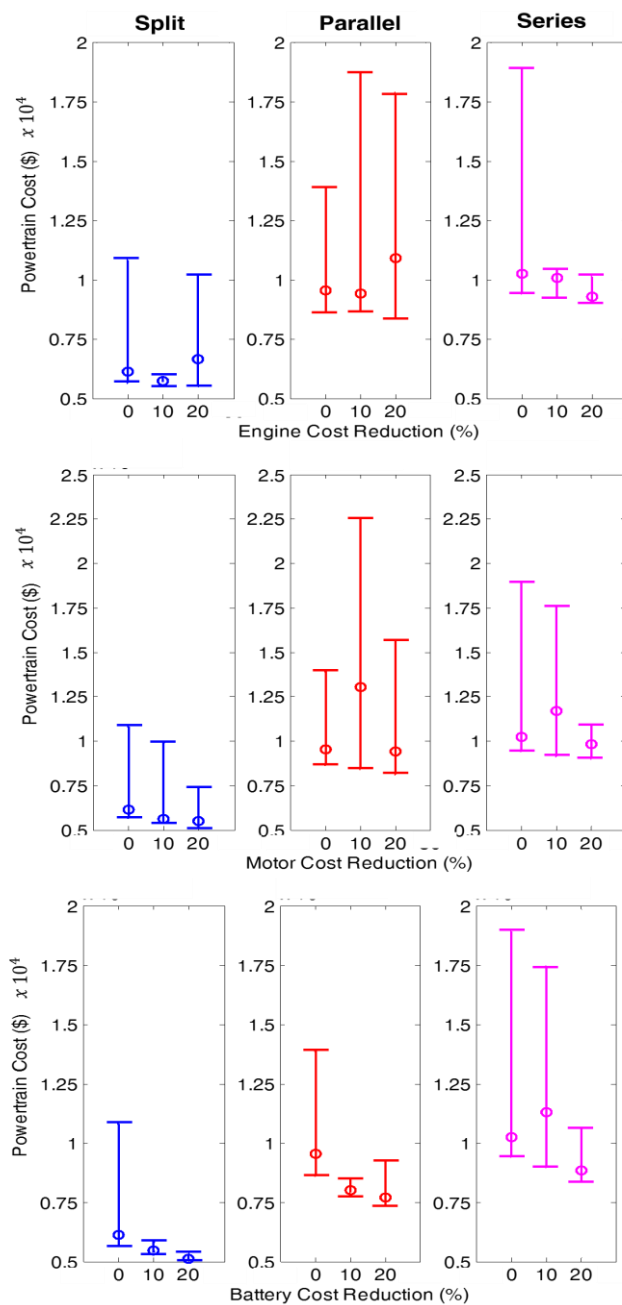

Figure 43 Sensitivity Analysis over HWFET drive cycle

However, the engine can also operate as a generator to recharge the battery as a supplemental source, consequently performs more efficiently in highway driving condition with respect to urban frequent stop-and-go conditions as the engine can operate more efficiently by active in higher road load conditions. If the price reduction is increased, then it is observed that the Series HEVs performed well even though they have a larger but lower cost engine compared to Parallel HEVs. So, in the case of a small price reduction in the engine, the ranking among the powertrains is: Split > Parallel > Series; for larger price reductions it becomes: Split > Series > Parallel. Similar characteristics are observed in the case of motor price cuts as Series HEVs usually use larger size motors but, in this case, the costs are comparatively lower. The Parallel HEVs perform better in highway conditions compared to city driving conditions even when the price of the battery is reduced; the competitiveness among the VPA remains the same (Split > Parallel > Series).

6.1.4 HEV vs. CV Selection Decision

To evaluate the net cost effects on hybrid vehicle lifecycle, the total cost associated with vehicle ownership is calculated with regards to powertrain component costs (engine, electric motor, generator), net present value of operational costs and the cost of battery replacement (both with or without conditions are considered). The following formula represents the current value of total cost associated with vehicle lifetime:

$$C_{total} = (C_{ICE} + C_{M/G} + C_{BAT}) + \sum_{n=1}^N \left\{ \frac{C_{OP} \times d_{annual}}{(1+r)^n} \right\} + \gamma \left\{ \frac{C_{BAT}}{(1+r)^N} \right\} \quad (12)$$

Here, it is assumed that each vehicle annually travels up to $d_{annual} = 20,000$ km as per EPA published report [112]; also the lifetime of a hybrid vehicle is considered to be $N = 12$ years, consequently the total vehicle lifetime mileage $d_{life} = 240,000$ km. However, the fundamental conclusions are unchanged if annual mileage is reduced up to $d_{annual} = 10,000$ km or vehicle life increased up to $N = 15$ years. The initial cost of purchasing the base vehicle excluding battery pack is $C_{VEH} = \$17,600$ which is considered to be the same for both ICEV and HEVs (and is therefore excluded from the calculation). Engine, Motor/Generator, and Battery costs are calculated based on Equation (1) – (4).

The second term related to operational costs C_{OP} is the multiplication of fuel cost (\$/L) and fuel consumption or economy (L/100km) and Equation (6) is used to evaluate it. Regular maintenance costs are assumed similar between various architectures and are therefore excluded. The net present value of annual operational costs is assessed using a discount rate $r = 7\%$.

The third term is the present value of battery replacement if it occurs, where $\gamma = 1$ for one time replacement and $\gamma = 0$ for no battery replacement after the battery lifetime expire (11th year as currently manufactured Li-Ion battery life expectancy is approx. 10 to 12 years).

In future research study, there is a possibility of using more advanced battery models and this is just a first pass approximation.

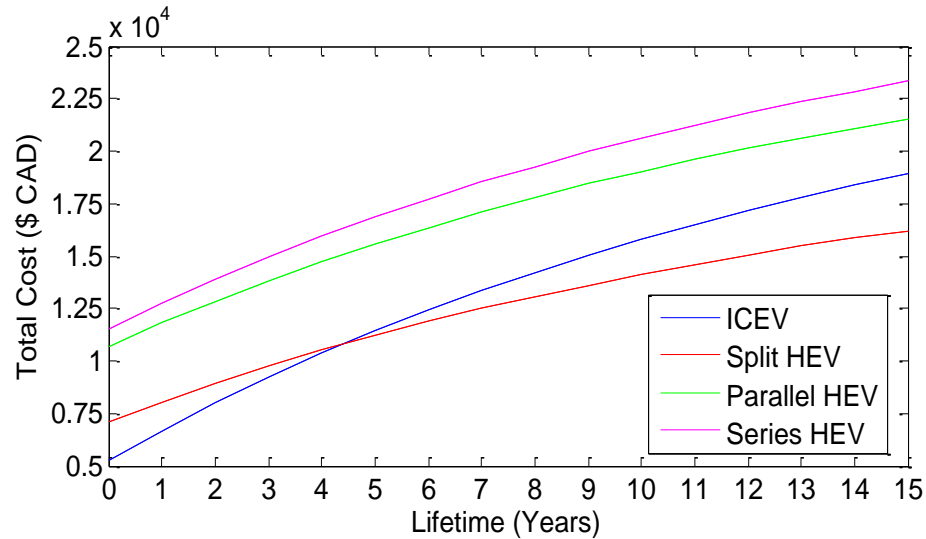

Figure 44 Tipping point calculation on TCO w/o battery replacement

According to Figure 44 and Figure 45 it is clearly observed that with the present HEV manufacturing cost and gasoline price (assumed \$1.20/L), Series and Parallel HEV will not be beneficial within a vehicle's lifetime (expected life is approx. 15 years) even if it possess optimized powertrain components.

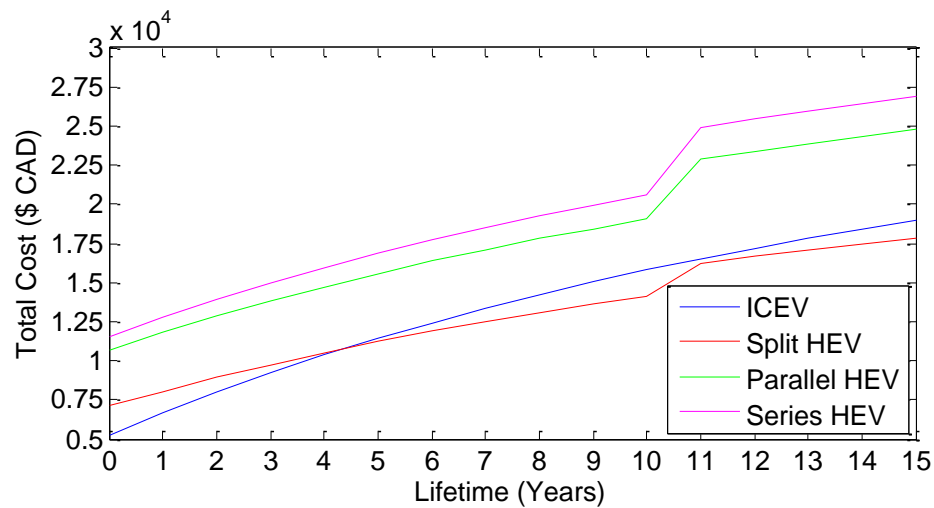

Figure 45 Tipping point calculation on TCO with battery replacement

However, the optimized Split HEV will become an overall cost saver after approx. 5 years or 100,000 km (with or without battery replacement) from the day of purchase. Moreover, it has also been observed that even with cost reductions of powertrain components up to 20%, there are no significant savings from either the Series or Parallel HEV. On the other hand, only the Split HEVs will have approx. 15% (without battery replacement) and 5% (with battery replacement) cost savings during the vehicle's lifetime.

6.2 Paper 2 – Optimization of Plug-in Hybrid Electric Vehicles

Paper 2 discusses the influences of driving patterns, powertrain component sizing, and total cost of vehicle ownership of prospective of PHEV drivetrains. It also analyzes the results of a simplified TCO and powertrain optimization model of plug-in hybrid electric vehicles. These analyses include the following:

- (1) A multi-objective optimization study of powertrain components over the simulated baseline vehicle model utilizing both established urban and highway driving conditions to discover what range and combination of components of the model are playing key roles in determining PHEV powertrain architecture.
- (2) A comprehensive sensitivity analysis has been conducted over a simplified TCO model to determine which factors are playing the key roles in PHEV design over the vehicle lifetime.
- (3) A thorough investigation of the breakeven region for energy pricing (gasoline and electricity price) is done across the breadth of optimized PHEV configurations.

(4) The integration of utility factors (UF) determined from the daily travel data of the Travel Survey of Residents of Canada (TSRC) are applied in order to assess the future potential of PHEVs by overcoming the established CV in the current transportation market.

All the results based on above mentioned analyses allow for the rigorous study including the possibility, factors, and outcomes associated with the proposed PHEV powertrain optimization, design, and total cost of ownership (TCO) modeling.

6.2.1 Impact of Driving Cycle on Component Sizing

In this study, the optimization process is carried over the urban (UDDS) as well as a highway (HWFET) driving cycles to assess the impact of driving patterns on powertrain component sizing.

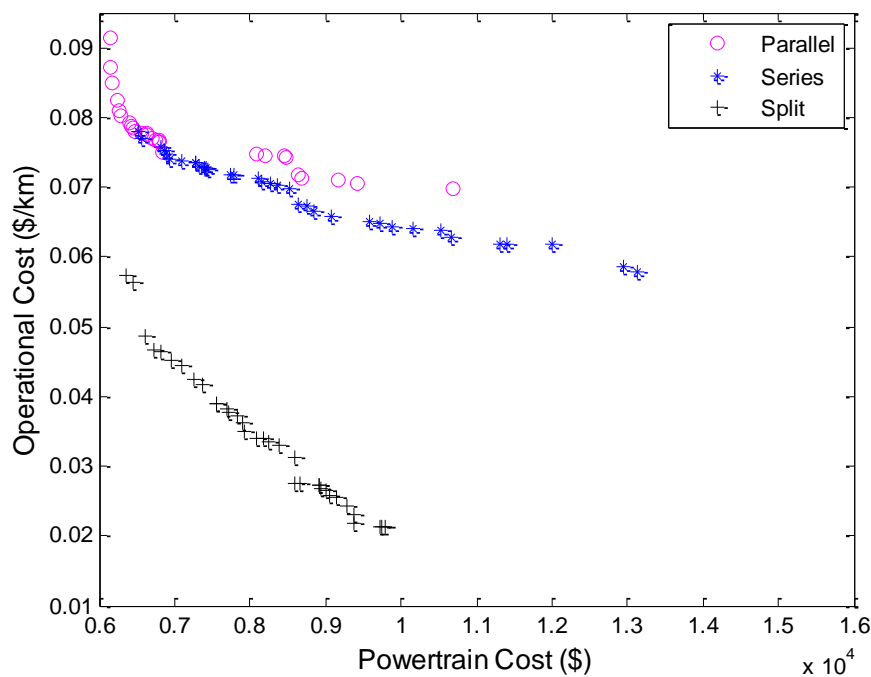

Figure 46 Powertrain vs. Operational cost over UDDS drive cycle

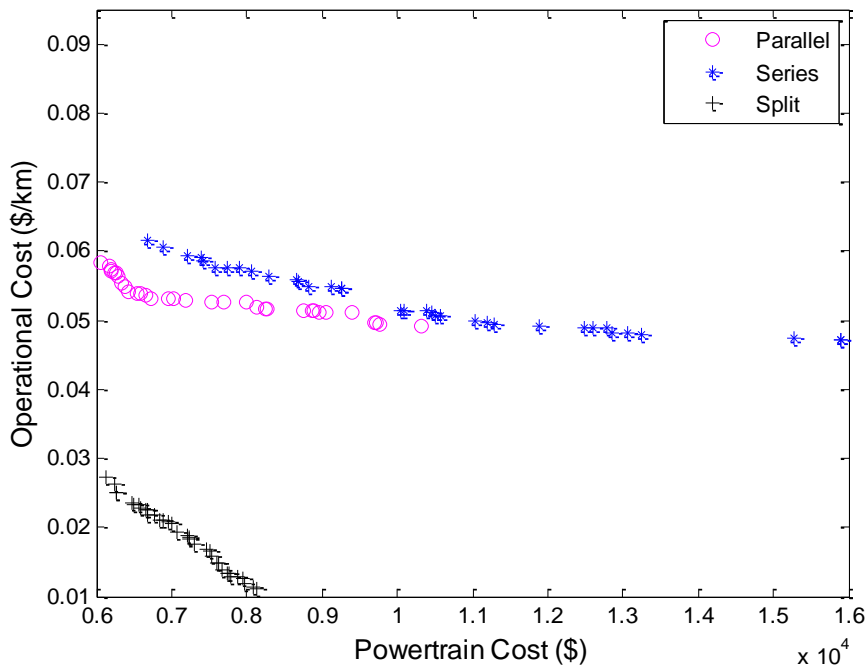

Figure 47 Powertrain vs. Operational cost over HWFET drive cycle

At first, the plug-in hybrid vehicle powertrain configuration is optimized aiming to minimize the cost of the powertrain (in \$) and the cost of operation (in \$/km) to determine a Pareto front of possible architectures, shown in Figure 46 and Figure 47. The optimized result shows that the power-split configuration is a significantly better choice because it becomes a less costly vehicle in terms of operational cost with respect to other vehicle powertrain architectures in any driving conditions. On the contrary, the parallel configurations use a smaller battery pack (shown in Figure 49, Figure 49), and the internal combustion engine is directly connected with the wheels, the efficiency of converting mechanical power to electricity and back is eliminated, consequently increasing the efficiency on the highway. That's why the Parallel PHEVs are more efficient and have reduced fuel consumption on the highway (shown in Figure 47 as less operational cost) driving conditions relative to frequent urban stop-and-go conditions.

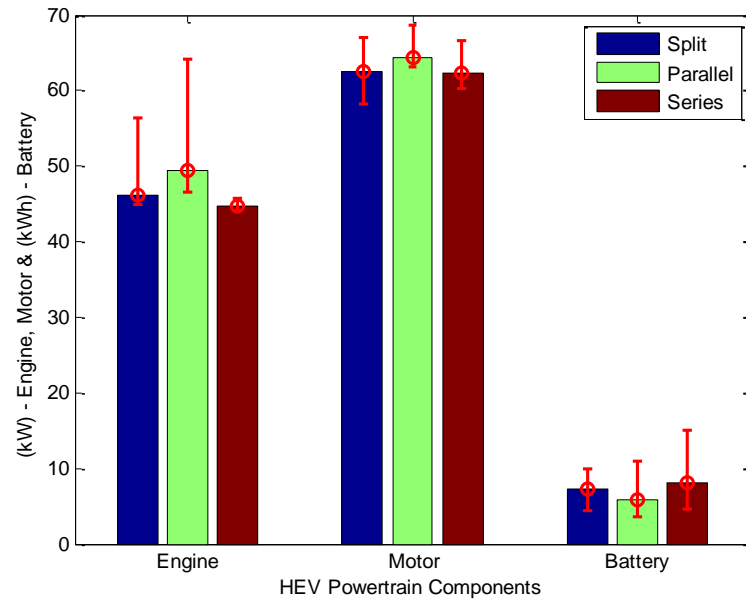

Figure 48 Pareto solution of powertrain component sizing over UDSS drive cycle

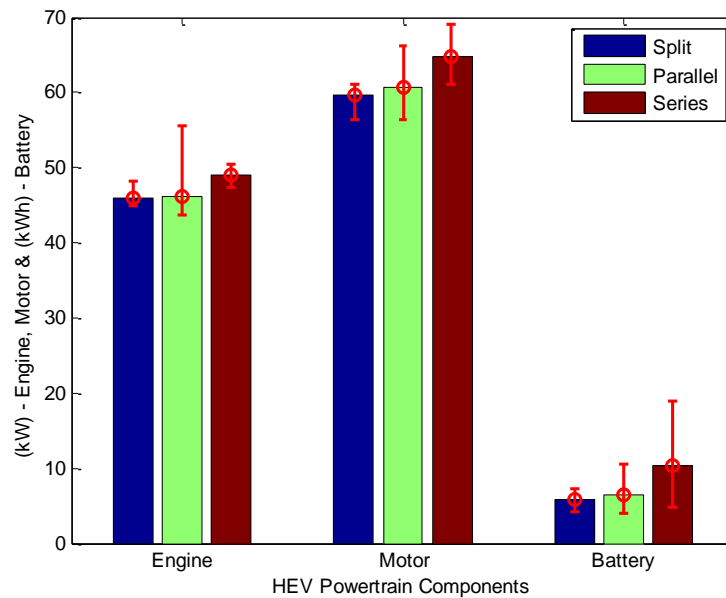

Figure 49 Pareto solution of powertrain component sizing over HWFET drive cycles⁴

⁴ Means with “error” bars for two cases: powertrain component (engine, motor, and battery) sizing for various PHEV powertrain architecture over both the city and highway driving conditions. The columns denotes the data mean and the bars on the centre show range. Note also that although the range error bars encompass all of the Pareto optimized solutions.

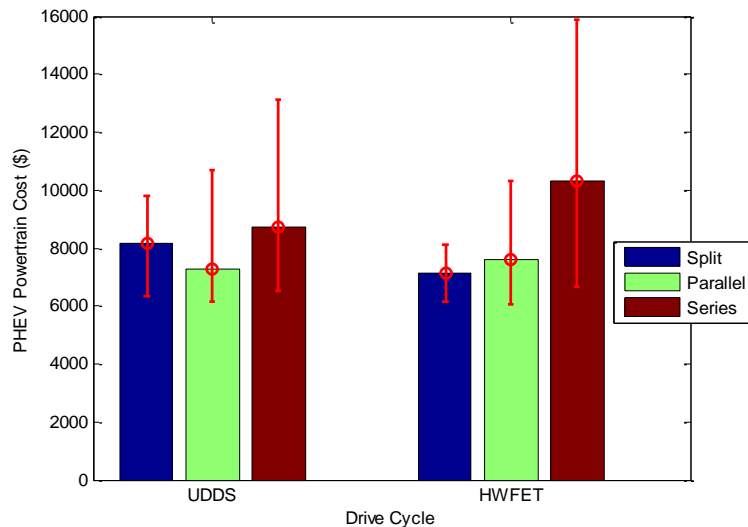

Figure 50 Powertrain cost for different drive cycles

According to Figure 50 and Figure 51, the power of the Engine or Motor increases along with the aggressiveness of the driving cycle, and consequently higher powertrain cost and vehicle mass obtained. Due to having a larger battery, electric motor and necessities for a separate generator, the series plug-in hybrid vehicle becomes more expensive compared to a parallel plug-in hybrid vehicle.

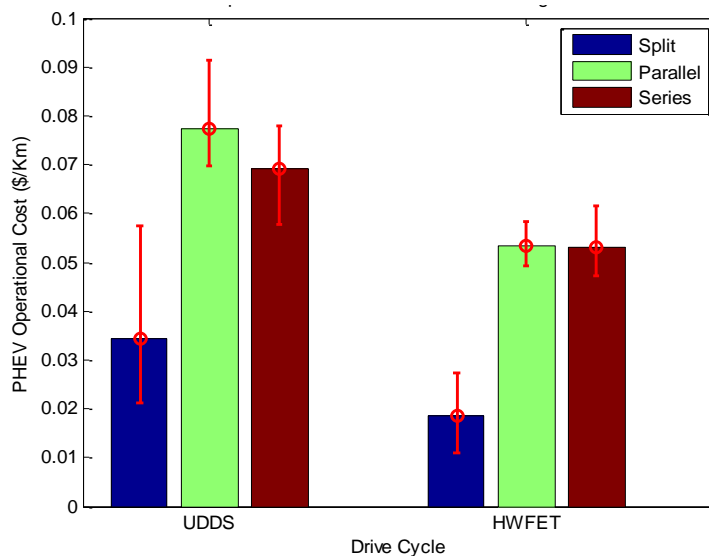

Figure 51 Operational cost for different drive cycles

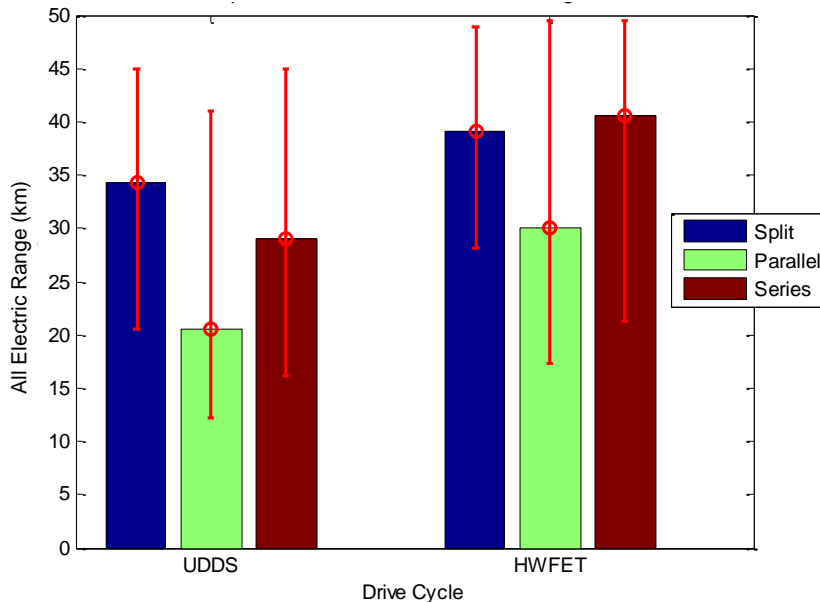

Figure 52 AER ranges for the optimal spectrum of PHEVs

As earlier, it has been mentioned that to evaluate the impact of drive cycle on the powertrain component sizing, the optimization process needs to be carried over well-established driving cycles like UDDS and HWFET which are capable of representing both the city and highway driving patterns respectively.

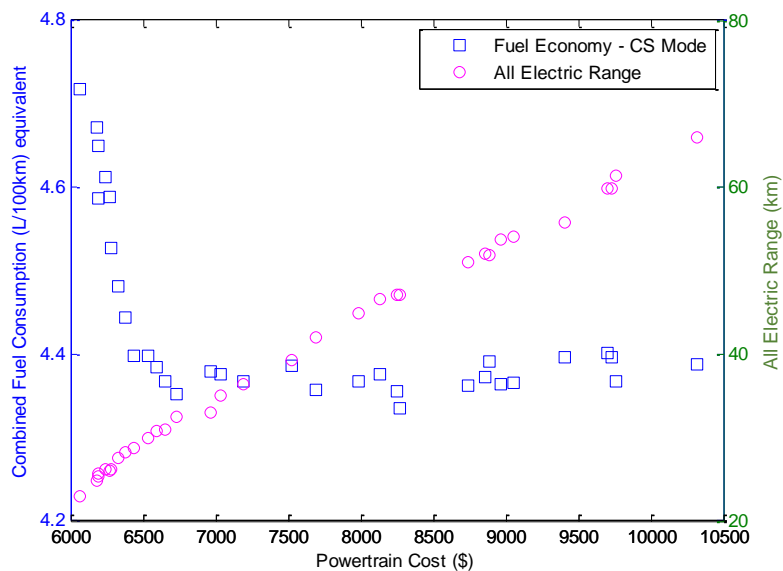

Figure 53 Powertrain cost with respect to charge sustaining and depleting mode

The obtained corresponding powertrain and operational cost are compared in Figure 50. As per the figures, the energy and power of the battery increases noticeably with the aggressiveness of the driving cycles, and consequently, higher powertrain costs and lower operational costs are obtained. The operational cost is reducing with the increasing trends of battery size as the all-electric range (km) of the vehicle is becoming higher as shown in Figure 52. This means that the vehicle needs less gasoline fuel (presented in Figure 53) and so reduces gasoline cost. This high-power electric drive capability does have some advantages. If the engine never turns on even during a very aggressive driving cycle, the vehicle will emit zero tailpipe pollutants. This potential emissions benefit led the CARB to award PHEVs achieving 10 miles of AER a much larger credit weighting toward the state's zero emission-vehicle (ZEV) regulation, as compared to PHEVs employing an engine-assistance strategy [113]. Also, such PHEVs can provide the driver with the feel of quiet, smooth all-electric operation while completing the all-electric drive range without the engine. However, oversizing the electric motor and ESS has a significant disadvantage: cost. To make the battery economically viable, a higher-energy, constant-power ESS should be constructed from batteries with a lower power-to-energy ratio that are less expensive on a dollar-per-kW basis greater than in the current HEV battery. This is one of the drawbacks in developing a full EV-capability PHEV for the AER requirement

6.2.2 Effect of Sensitivity Analysis on Total Cost of Ownership (TCO)

Nowadays, consumers are becoming more conscious than 50 years earlier regarding environmental issues like climate change, GHG emissions and scarcity of petroleum. In order to overcome these issues, the transportation sector can influence a lot by reducing

the fuel expenditure and in this regard the prospective of a PHEV is promising. However, consumers' acceptability does not only depend on environmental issues but also the investment towards buying and maintaining a vehicle for its lifetime. To represent the economic views, here the effect of sensitivity analysis over simplified TCO is studied.

The total cost of vehicle ownership is mainly composed of 4 parts:

- i. Incremental Powertrain Cost
- ii. Battery Replacement Cost
- iii. Fuel Cost
- iv. Electricity Cost

Table 7 summarizes all the key parameters used in the sensitivity analysis of vehicles lifetime total cost of ownership to electricity price, gasoline price, discount rate, vehicle lifetime, annual mileage and cost of vehicle powertrain components.

Table 7 Sensitivity analysis of key cost parameters

| Input Variables | Min Input | Base Case | Max Input | Unit |
|------------------------|------------------|------------------|------------------|-------------|
| Gasoline Price | 0.65 | 1.30 | 1.95 | \$/Litre |
| Electricity Price | 0.25 | 0.10 | 0.05 | \$/kWh |
| Discount Rate | 11% | 7% | 2% | % |
| Vehicle Lifetime | 10 | 15 | 20 | Year |
| Annual Mileage | 10000 | 20000 | 30000 | Km |
| Engine Cost | 6.00 | 12.00 | 18.00 | \$/kW |
| Motor Cost | 32.66 | 21.78 | 10.89 | \$/kW |
| Battery Cost | 976.80 | 651.20 | 195.36 | \$/kWh |

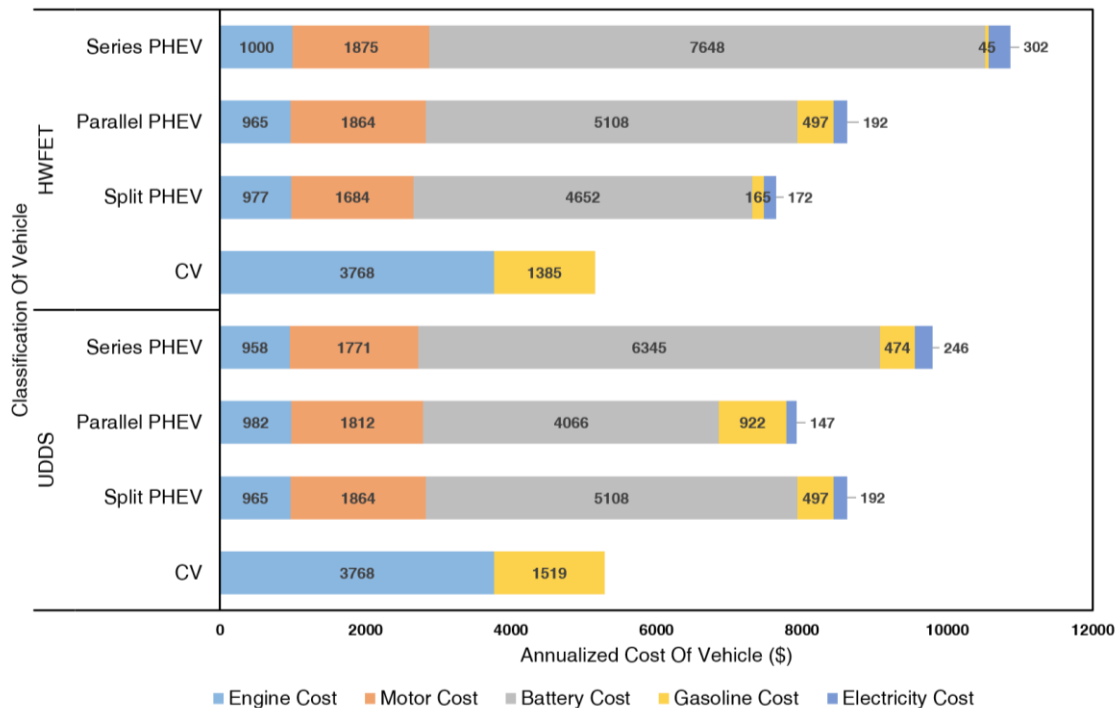

Figure 54 Lifecycle equivalent annualized cost under different drive cycles

Here, the focus is on the comparison between two contrasting drive cycles: HWFET and UDDS (Figure 54) and the ranges for all the cost factors are assumed based on short and long-term vehicle development scenario.

The drivetrains shown in Figure 54 represent the best point along the Pareto front (for the baseline input values) based on optimizing TCO.

The results presented next show the savings relative to the baseline (+ = PHEV beneficial, – = ICEV beneficial) and demonstrates how the outcomes would change under alternative assumptions using tornado diagrams.

In this study, the tornado diagrams are used to represent the deterministic sensitivity analysis by comparing the relative significance of cost parameters associated with the total cost of vehicle ownership. For each parameter or uncertainty considered, one needs

to estimate for the low, base and high outcome scenarios and their corresponding values. The parameters associated with the sensitivity analysis are modeled as uncertain values while all other parameters are held constant (baseline values) which allows testing of the sensitivity related to each parameter.

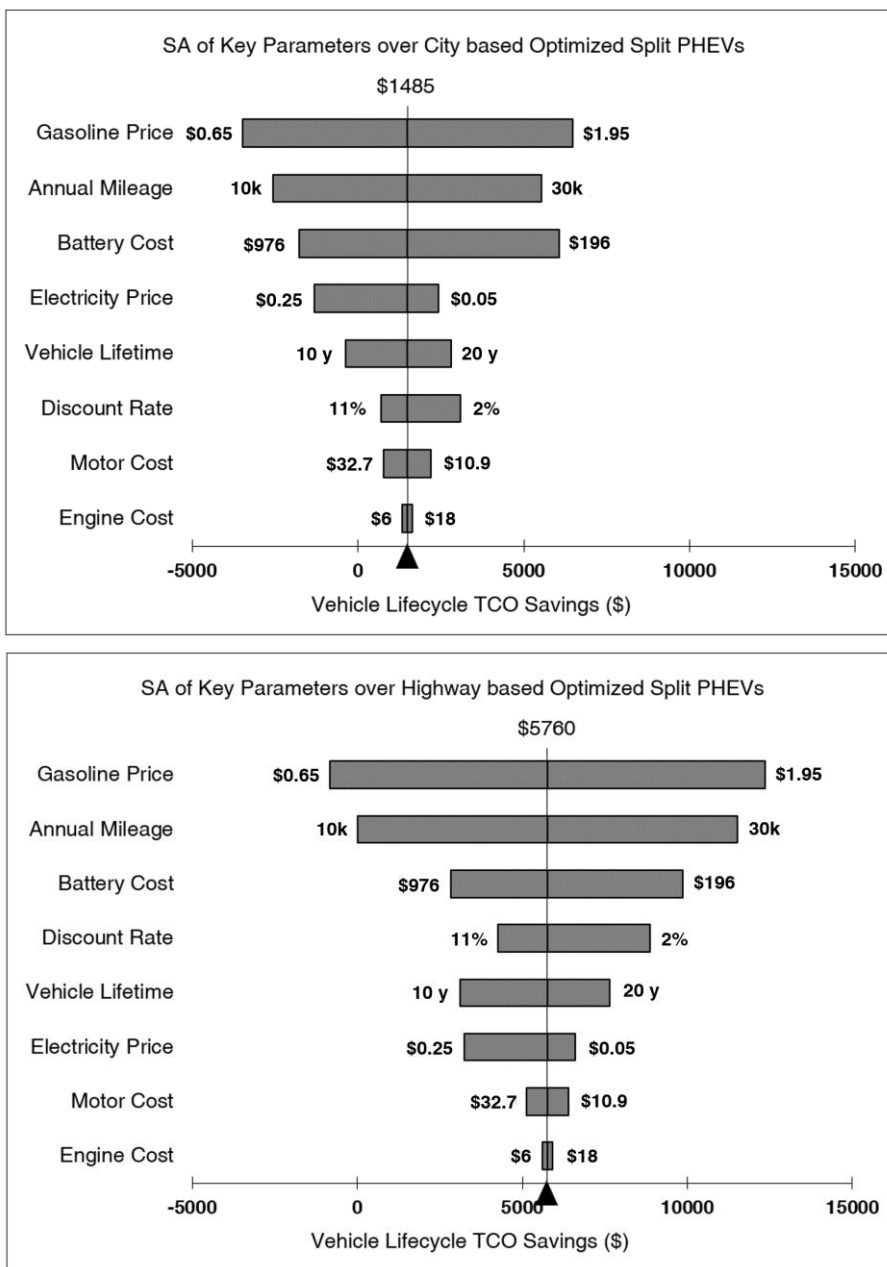

Figure 55 Sensitivity Analysis of key cost parameters over TCO of Split PHEV

All the parameters are listed vertically, and the categories are ordered in a way so that the data associated with the largest bar appears at the top of the chart, then the second influential one appears second from the top and so on.

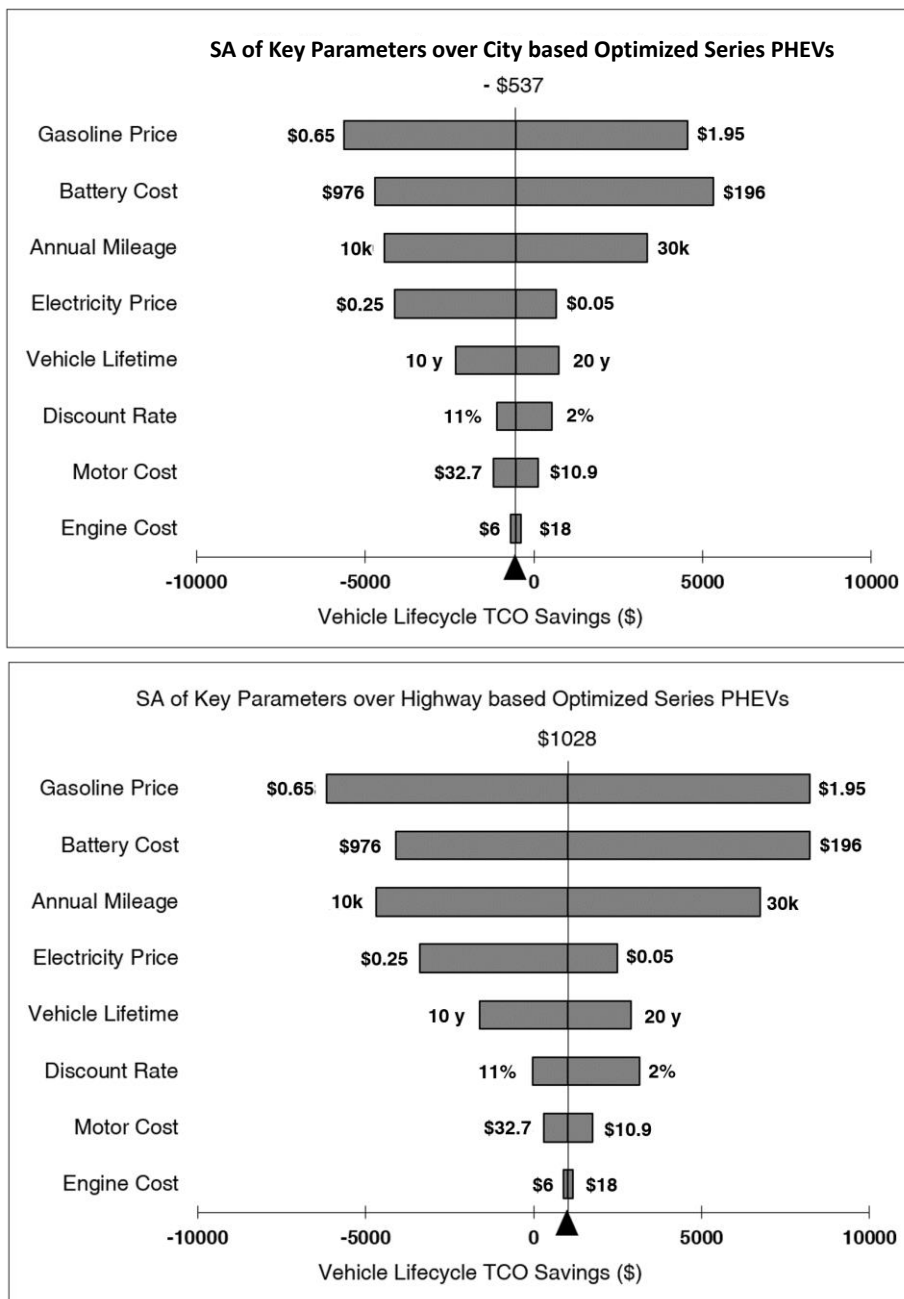

Figure 56 Sensitivity Analysis of key cost parameters over TCO of Series PHEV

All the figures illustrate that increased gas prices make PHEVs more economical and affects the cost of ICEVs most dramatically. Vehicles with large battery packs like Series or Parallel PHEVs (especially, city based optimized VPAs) remain higher cost.

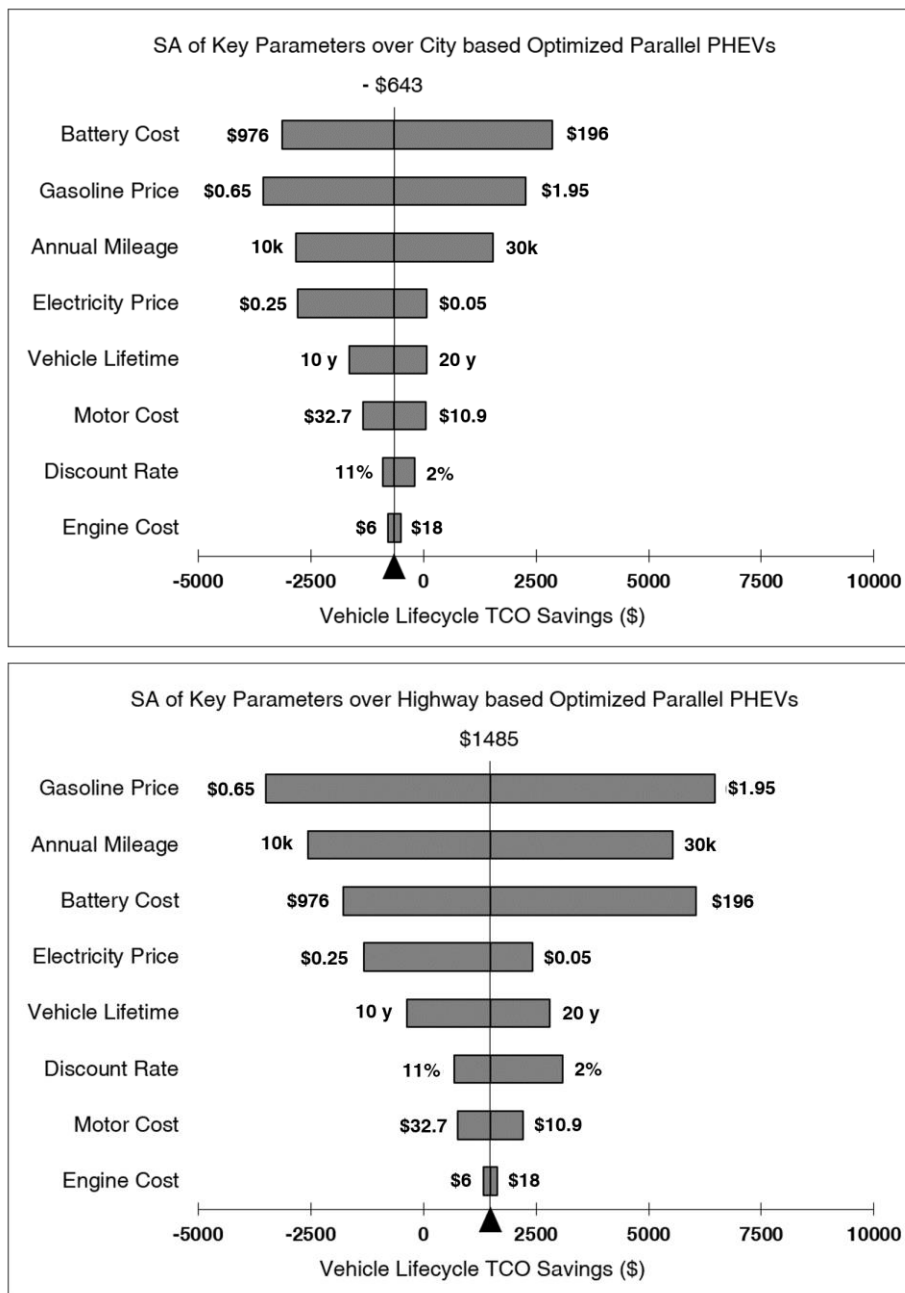

Figure 57 Sensitivity Analysis of key cost parameters over TCO of Parallel PHEV

Moreover, the price of electricity is a most influential parameter that affects the cost of PHEVs with large battery packs. If the price of electricity increases within 75% of 0.10 \$/kWh, it has a notably smaller overall effect that doesn't make PHEVs a less economic solution with respect to ICEVs.

All the figures of sensitivity analysis emphasizes that annual (or lifetime) mileage and cost of the battery have a significant effect on the cost benefits of PHEVs and even become one of the most influential cost parameters that might be responsible for PHEVs acceptability towards for consumers. It also reveals that while high/low engine or motor costs have negligible impacts on vehicle life cycle costs, they do slightly change the relative costs of the powertrain options. Moreover, the impact of consumer discount rate is also examined. It has been found that as the discount rates increase, the plug-in hybrid vehicles becomes less favourable compared to ICEVs and the cost benefits become delayed to future years, but does not change the overall cost-effectiveness of PHEVs.

On the other hand, the effect of vehicle lifetime has significant impacts over the vehicle lifecycle. If the vehicle lifetime rises then, the ICEV becomes less beneficial than PHEVs as age causes depreciation of gas fuel economy of ICEVs much more as it only depends over the gasoline to operate a vehicle.

6.2.3 Breakeven Point (BEP) Analysis over Lifecycle Cost

Figure 58 demonstrates the cost variation between HEVs and ICEVs with respect to the change in price of gasoline. This study also considers the effect of short term to long term scenarios by varying prices from the high end to low end in order to cover worst case

scenarios. However, the primary objective of breakeven point (BEP⁵) analysis is to observe the changes that need to be occur in the gas price by keeping all other cost associated with vehicle lifecycle until the HEV becomes less costly than the ICEV.

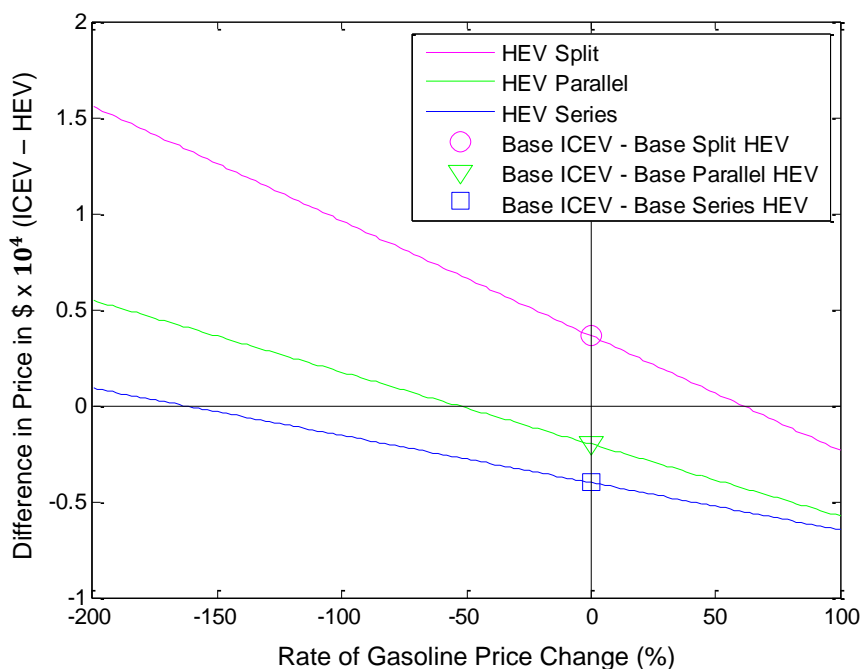

Figure 58 BEP analysis for the cost of CV and HEV by altering gasoline price

It has been found that the optimized HEVs except Split HEV are not profitable during their lifetime with the assumption of current gasoline price. In order to transform the HEVs into an economical alternatives of ICEV, the gasoline price needs to be raised by 50% (\$0.65/Liter[↑], reasonable) and 160% (\$2.00/Liter[↑], un-reasonable) within the vehicle lifecycle for Parallel and Series HEVs respectively. On the other hand, the Split HEV is economic either with the current gasoline price assumptions or if the price

⁵ Breakeven Point (BEP) is an analysis to evaluate the point at which the cost associated with ICEV lifetime is becoming equal to the cost associated with HEVs or PHEVs. It calculates the margin of profits or loss among two different scenarios.

decreased. Moreover, the ICEV would be beneficial if the gasoline price is reduced approximately 60% ($\$0.80/\text{Liter}\downarrow$, un-reasonable) which is beyond expectation.

A similar BEP analysis was done for PHEVs with respect to ICEVs except the effect of electricity price is also included; the results are shown in Figure 59. Both the figures specified that the baseline vehicle costs are quite firmly located among the different vehicle powertrain architectures.

However, the gasoline prices need to drop approximately 50% ($\$0.60/\text{Liter}\downarrow$, un-reasonable), 70-85% ($\$0.85/\text{Liter}\downarrow$, unreasonable) and 75-85% ($\$1.00/\text{Liter}\downarrow$, un-reasonable) within the vehicle lifetime in order to make ICEV beneficial compared to Series, Split and Parallel PHEV respectively which seem to be beyond reasonable expectation based on the history of gasoline price all over the world. Overall, the study is clearly showing that even the initial investment for PHEVs are higher but due to the presence of all-electric mode, and the price of electricity is being comparatively cheaper than gasoline, PHEVs become beneficial if the comparison takes place over the whole vehicle lifecycle.

Based on the graphical representation, it has been found that if the price of gasoline is continuously rising as it did over the last 50 years or so, then PHEVs will take over the ICEVs in terms of lifecycle cost (only if it is assumed that the maintenance cost is same for both or higher for ICEV). If there are any unpredictable scenarios like the recent price drops which happened in the year 2014-15, then this could make the ICEV cheaper overall compared to the PHEV.

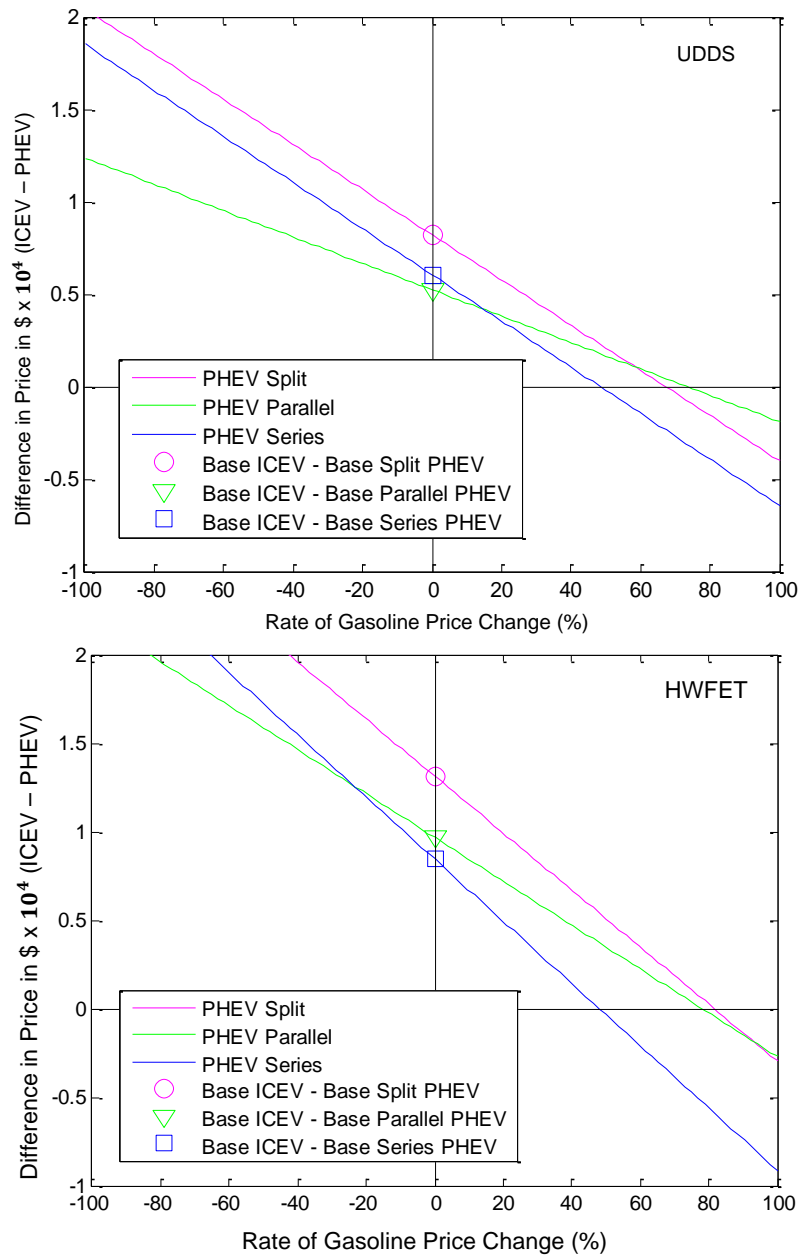

Figure 59 BEP analysis for the cost of CV and PHEVs by altering gasoline price

In Figure 60, the effect of price variation of electricity is evaluated in order to equate the lifecycle cost of PHEV to ICEV. To achieve this scenario, all the prices associated with the total cost of vehicle ownership remain constant during the variation study of electricity price. Other cost parameters are unchanged during this process, considered to be the limitation of BEP analysis. The figure is indicating that if the price is increased by

approximately more than 200% ($\$0.2/\text{kWh} \uparrow$) to make the costs of ICEV and PHEV same. It is also showing that as the price of electricity trends upward, the cost saving of PHEVs trend downwards almost linearly.

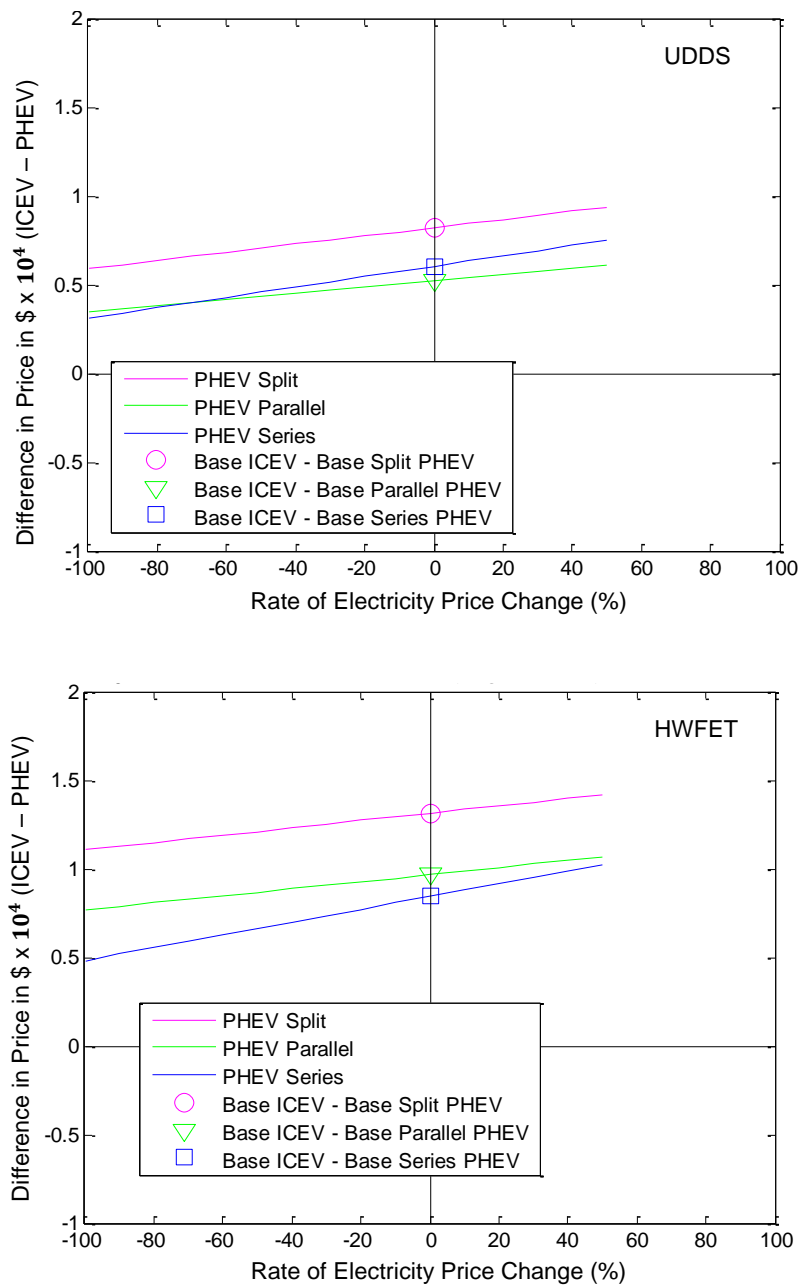

Figure 60 BEP analysis for the cost of CV and PHEVs by altering electricity price

6.2.4 Future Potential of Plug-in Hybrid Electric Vehicle (PHEV)

The prospects for PHEVs primarily depend on the capability of displacing petroleum, and originates based on numerous factors. First of all, the all-electric range of Plug-in HEVs need to be overlapped with the motorists' driving lifestyle - specifically, with the daily driving distance distribution profiles. According to Figure 61, the AER of PHEVs are typically falling within 50 km - 125 km).

Figure 61 illustrates the Canadian fleet of personal vehicles daily driving distribution profiles in km and cumulative utility factor (UF) curve which are sourced from 2010 Statistics Canada transportation survey [80]. It can be seen that 75% of days, the fleet vehicles are traveling relatively short distances within 65 km.

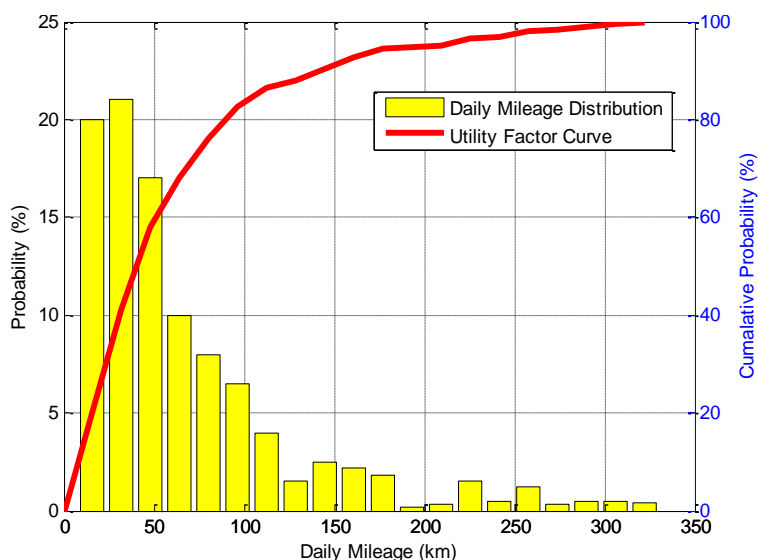

Figure 61 Daily mileage distribution of Canadian motorists

Moreover, those vehicle also possess the ability to reduce 50% of fleet gasoline consumption by considering that each vehicle are re-charging its battery once a day. In the similar fashion, a PHEV100 is able to displace gasoline usage by electricity about

85% of the time. As significant portion of the distribution is within the lower end (100km as daily driving distan).

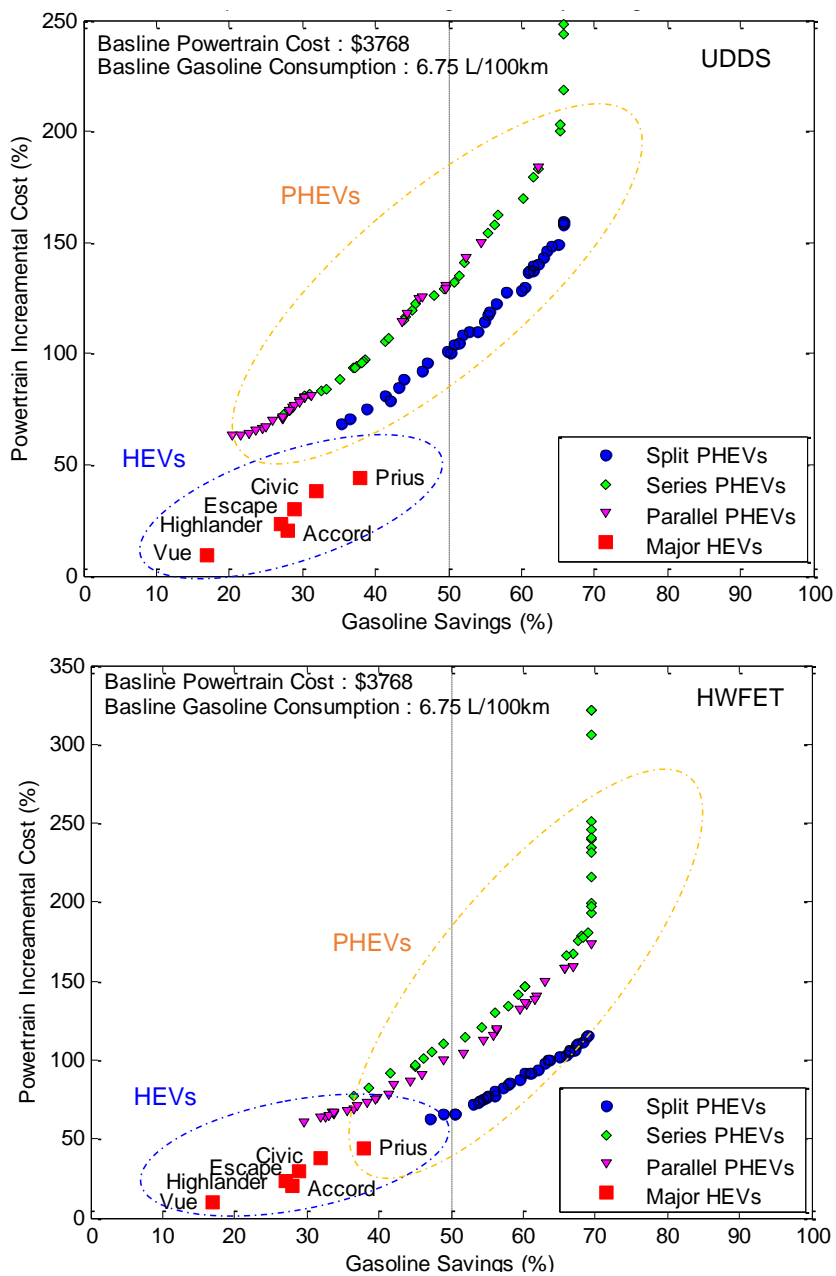

Figure 62 Powertrain costs and reduction of gasoline consumption for PHEVs

Figure 62 presents powertrain incremental costs with respect to the gasoline savings in percentage (%) within the design spectrum of Pareto optimal solutions (generated in Figure 46 and Figure 47) for various powertrain architectures associated with PHEVs.

Moreover, if the macroscopic view is taking into account, then it is clearly seen that as the AER increased, the PHEVx becomes more capable of reducing gasoline consumption. It has been found that none of the major HEVs (Vue, Accord, Highlander, Escape, Civic and Prius etc. [114]) achieve the maximum 40-50% reduction of gasoline relative to the baseline conventional vehicle (shown in Table 8). This scenario suggests that the benefits of powertrain hybridization have an upper limit. PHEVs are exceeding this upper limit due to the availability of CD or All-Electric mode increasing PHEVx ranges can be seen to provide diminishing returns due to the nature of the Utility Factor curve (shown in Figure 61).

Table 8 Gasoline savings and powertrain incremental cost based on baseline CV

| Conventional Vehicle (CV) - Baseline Platform | | | |
|--|-------------------|--------------------|----------------------|
| Powertrain Cost: \$3768 | | | |
| Gasoline Consumption : 6.75 Litre/100 Km | | | |
| Parameters | Split PHEV | Series PHEV | Parallel PHEV |
| Gasoline Savings | 40 - 70 % | 30 - 65 % | 20 - 65 % |
| Powertrain Incremental Cost | \$ 1800 – 5600 | \$ 2000 - 11000 | \$ 1800 – 5600 |

PHEVs reduce gasoline consumption further, ranging from 20% - 65% for the Parallel PHEVs, up to 30 % - 65% for Series PHEVs and 40% to 70% for Split PHEVs. However, this increasing trend of gasoline savings come at increasing costs associated with vehicle powertrain architecture. So, in order to observe PHEVs full potential among the standard vehicle lineup, significance of incremental powertrain cost over the vehicle lifetime has been conducted.

To do this cost-benefit analysis of plug-in hybrid electric vehicles, a simplified comparative study based on total cost of ownership is conducted among various PHEV powertrain architectures over the vehicle lifecycle. However, the comparison only considered the summation of incremental powertrain cost, and total operational cost (both electricity and gasoline price). The cost associated with maintenance is entirely neglected to reduce the level of complexity. Figure 63 and Figure 64 presents techno-economic comparisons with or without considering the effect of battery replacement respectively based on Eqn. 8 (see Section 4.5, Page 42). While evaluating lifecycle energy consumptions, it is assumed that each vehicle travels 24,000 km each year to keep the annual mileage assumptions consistent with EPA [35]. The vehicle configurations for each category are selected based on best design points over the Pareto optimal design spectrum (Figure 46 and Figure 47) in terms of TCO over the vehicle lifetime.

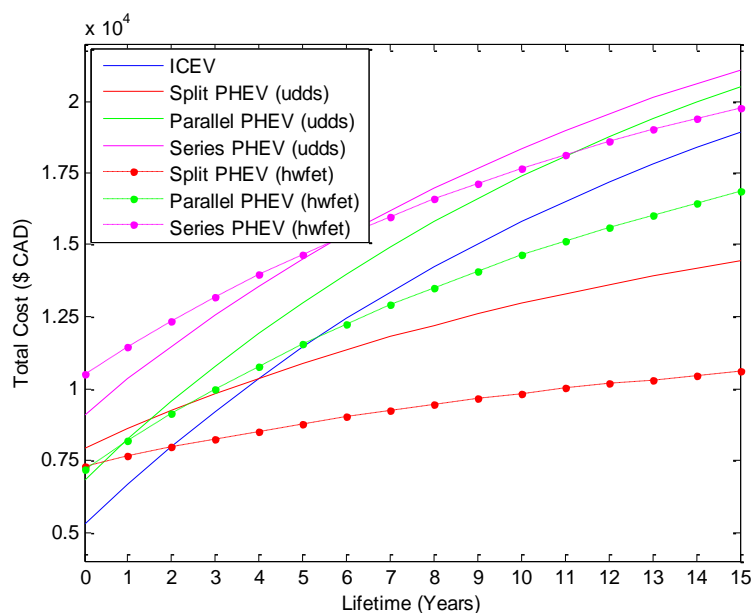

Figure 63 TCO over vehicle lifetime without ESS replacement

Here, the current market retail price of gasoline is considered as the representation of a near-term scenario; it is assumed 1.3 \$/L, and the retail price of electricity is assumed

0.10 \$/kWh based on Canadian historical data and average retail prices of both electricity and gasoline in the year 2015. Moreover, a rate of 7% mark-down is considered for future cash-flows. In Figure 63, without the battery replacement scenario, the Split (both city and highway conditioned) and Parallel (the only highway conditioned) PHEVs become cost savers compared to conventional vehicles within their first 5 years of vehicle lifetime.

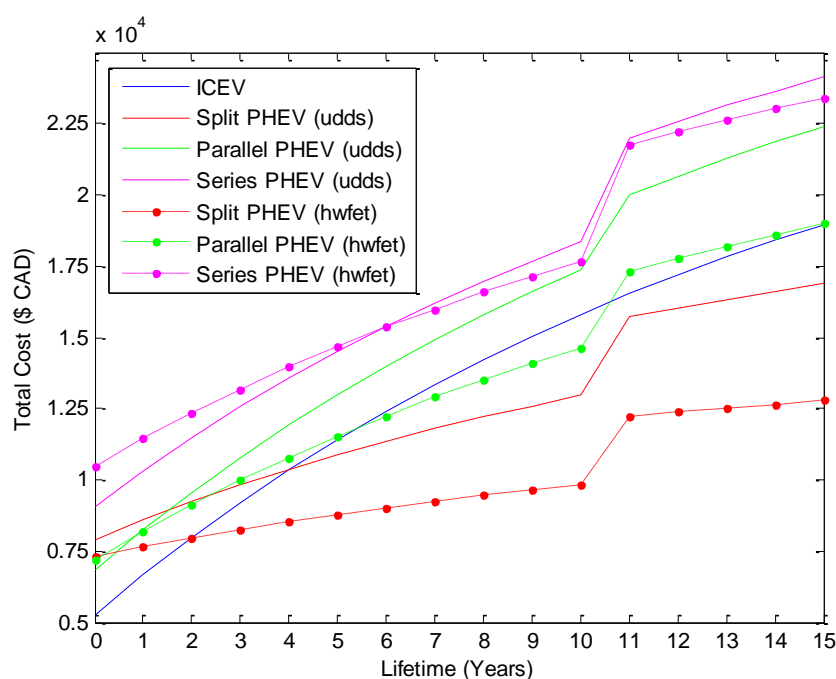

Figure 64 TCO over vehicle lifetime with ESS replacement

However, the other configurations such as Series PHEV (both city and highway conditioned), Parallel PHEV (only city conditioned) fail to overcome their incremental cost difference over the vehicle lifetime⁶ either due to larger size of powertrain component as well as excessive initial powertrain cost difference or the fuel economy is not high enough compare to conventional vehicle. Figure 64, illustrates the battery

⁶ Here, the vehicle lifetime is assumed to be 15 years based on [124]

replacement scenario, which provides a slightly different contrast, as the Split PHEVs remain as before even after the battery replacement occurred on 11th year, but the other PHEVs (both Series and Parallel) provide higher cost than the CV. Based on the above-mentioned comparisons, quite a few observations can be remarked on:

- a) The payback analyses are sensitive to the retail price of gasoline and vehicle powertrain system, which are significantly influenced by the cost assumption of battery manufacturing.
- b) The economic viability of PHEV is not good enough unless the retail price of gasoline remains the same or becomes higher compared to the current world market.
- c) The techno-economical acceptability of PHEV mostly depends on the improvement of all-electric range as well as the cost of battery manufacturing.

Nevertheless, it seems that a persuasive techno-economic model can be developed for PHEVs by considering projected (lower) battery costs and gasoline prices which are proposed in this study.

6.2.5 Comparison of CV, HEV, and PHEVs

The ICEV will cost the consumer an estimated approx. \$6000 as initial powertrain cost, whereas HEV and PHEV, will cost more (\$1k to \$10k more than ICEV) based on the Toyota Prius platform. But, if the operational cost is considered along with the powertrain cost then the overall scenario would be significantly different. The operational cost of the hybrid vehicle would be improved a bit but only for the split VPA but no other two VPAs (like Series or Parallel).

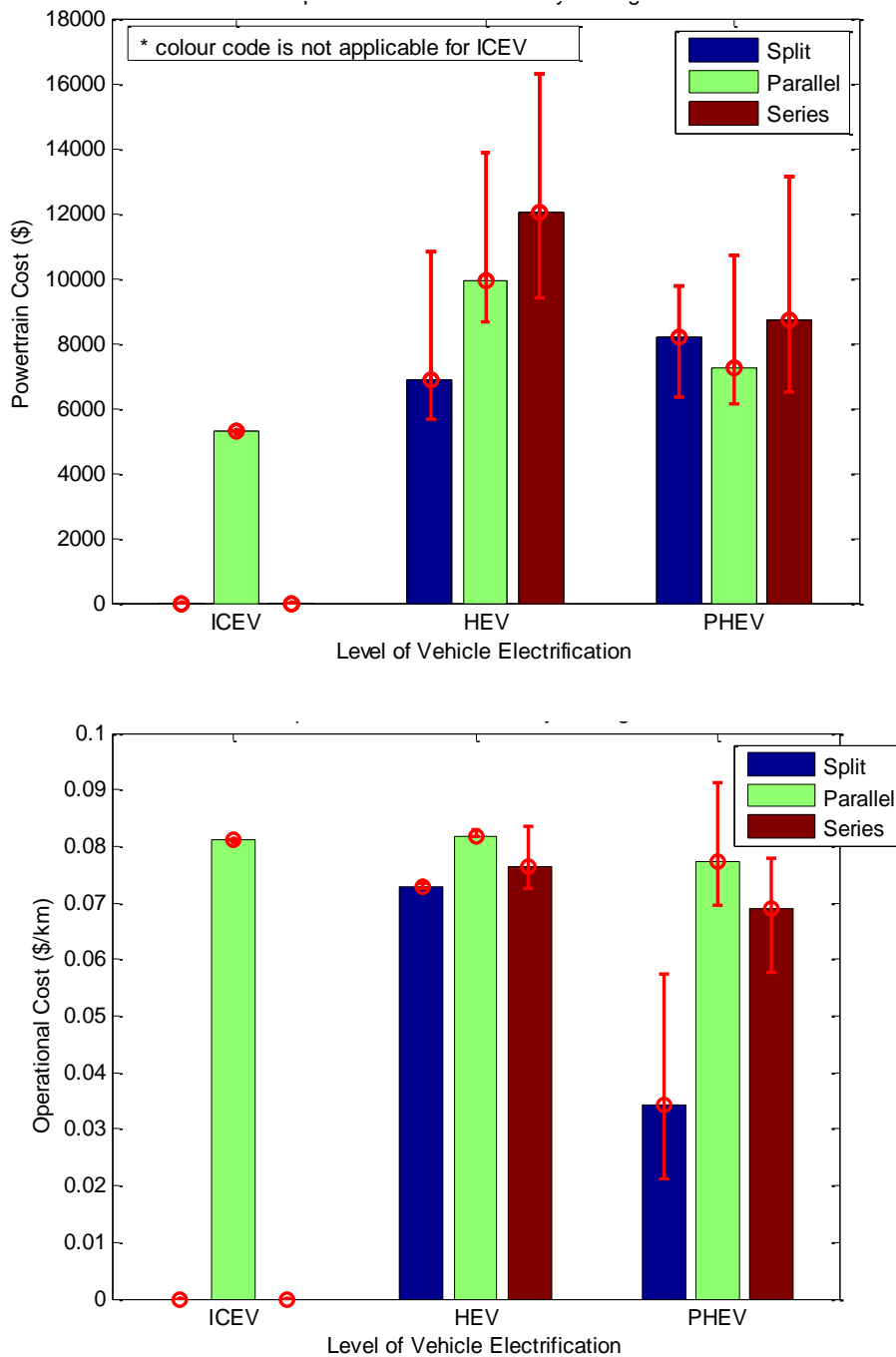

Figure 65 Comparison of powertrain and operational cost among different PHEVs

That is also clearly observed in Figure 63 where the lifecycle cost of the vehicle with or without battery replacement is plotted. However, there is a significant operational cost change are observed for Plug-in HEVs (shown in Figure 65).

The trend of the PHEV operational cost for various VPAs are similar to HEVs (Split > Series > Parallel) even though there is significant margin level among those operational cost per kilometers; such as the split VPA is approx. 0.04 to 0.06 \$/km (daily \$2.5 to \$4 savings) lower than ICEV and 0.035 to 0.0655 \$/km (daily \$2 to \$3.5 savings) lower than HEVs.

6.3 Paper 3 – Electric Vehicle Class Optimization

In paper 3, two types of electric vehicle class optimization are presented:

- (i) light duty vehicle class for Plug-in HEV
- (ii) a single platform with multiple types of electric propulsion system

6.3.1 PHEV – Light Duty Vehicle Class Optimization

The schemes for vehicle classification are established by either governments or private institutions (particularly, automakers, research laboratories or firms) for numerous purposes such as, to determine tax amount, emission regulations, load capacity and categorization for differentiation etc.

Prior to the discussion of vehicle categorization for this research based on a combination of vehicle curbing weight and volume, it is useful to elaborate those classification based on individual parameters which are already established by either US federal government regulations [115] or automakers in the context of North America. Light-duty passenger vehicles are typically categorized based on their curb weight and interior volume index or seating capacity except for two-seaters.

Table 9 Light-duty passenger vehicle classification by US EPA [115]

| Class | Interior combined passenger and cargo volume index in cubic feet (liters) |
|-----------------------|---|
| | Sedan / Car |
| Mini-compact Car | < 85 (2407) |
| Subcompact Car | 85 – 99.9 (2407 – 2831) |
| Compact Car | 100 – 109.9 (2832 – 3114) |
| Midsize Car | 110 – 119.9 (3115 – 3397) |
| Large (Full-size) Car | ≥ 120 (3398) |
| SUV | |
| Compact SUV | < 130 (3681) |
| Midsize SUV | 130–160 (3681–4531) |
| Large (Full-size) SUV | ≥ 160 (4531) |

Table 10 Light-duty passenger vehicle classification by US NHTSA [116], [117]

| NHTSA Classification | Curb Weight in lb (kg) |
|-----------------------|------------------------------------|
| | Sedan / Car |
| Mini-compact Car | 1,500 to 1,999 lb (680–907 kg) |
| Subcompact Car | 2,000 to 2,499 lb (907–1,134 kg) |
| Compact Car | 2,500 to 2,999 lb (1,134–1,360 kg) |
| Midsize Car | 3,000 to 3,249 lb (1,361–1,477 kg) |
| Large (Full-size) Car | 3,250 lb (1,477 kg) and over |
| SUV | |
| Compact SUV | < 3,250 lb (1,477 kg) |
| Midsize SUV | 3,250 to 3,500 lb (1,477–1,588 kg) |
| Large (Full-size) SUV | 3,500 lb (1,588 kg) and over |

In this study, based on above mentioned classifications, the light-duty vehicles are classified by considering the effect of mass, size and consumers vehicle choice diversity.

The following are the classes:

- (1) Compact Sedan
- (2) Full-Size or Large Sedan
- (3) Mid-Size SUV
- (4) Full-Size or Large SUV





| Class |  |  |  |  |
|---------------------|---|---|--|---|
| | Compact Sedan | Full-Size Sedan | Mid-Size SUV | Large SUV |
| Volume (Cubic feet) | 100 – 109 | 110 – 130 | 130 – 159 | 160+ |
| Curb Weight (lb) | 2500 – 3000 | 3000 – 3250 | 3250 – 3500 | 3500+ |

Figure 66 Light-duty vehicle classification

After categorizing the vehicle classification, a vehicle platform for each class had been developed and all the vehicles attributes (such as vehicle frontal area, drag coefficient, centre of gravity, wheel radius, and cargo mass) are calibrated based on ADVISOR vehicle models and ANL available performance data comes from joint ventures with OEMs.

Table 11 Vehicle attributes of light-duty vehicle classes [113], [118], [119]

| Parameters | Units | Compact Car | Large Car | Medium SUV | Large SUV |
|-------------------|-------|-------------|-----------|------------|-----------|
| veh_glider_mass | kg | 999 | 1025 | 1276 | 1683 |
| veh_CD | – | 0.3 | 0.3 | 0.41 | 0.43 |
| veh_FA | m^2 | 2.1 | 2.1 | 2.6 | 2.9 |
| veh_front_wt_frac | – | 0.6 | 0.64 | 0.4 | 0.4 |
| veh_cg_height | m | 0.5 | 0.5 | -0.5 | -0.5 |
| veh_wheelbase | m | 2.67 | 2.75 | 2.89 | 2.99 |
| veh_cargo_mass | kg | 136 | 136 | 136 | 136 |

Finally, using those parameters (shown in Table 11) for each class of vehicle, the same optimization procedure as given in section 5.2.4 (Page 54) is applied to all categories of PHEV. According to Table 12, the required power of the Electric Motor and the energy of the Battery increases with the rise of vehicle mass, and accordingly, higher powertrain cost (shown in Figure 68) and operational cost is obtained. As an example, the compact plug-in hybrid sedan is expected to be less costly compared to the mid-size plug-in hybrid SUV, due to the smaller battery and motor size. Moreover, due to a smaller amount of mass and size change in between compact and full-size sedan leads to a scenario that clearly shows that there is no substantial variation among powertrain components as well as the powertrain cost.

Table 12 Comparative powertrain component sizing of various light-duty vehicles

| Class | VPA Type | Engine (kW) | Motor (kW) | Battery (kWh) |
|----------------------|----------|-------------|------------|---------------|
| Compact Car | Series | 44 – 46 | 60 - 67 | 4.5 - 15.0 |
| | Parallel | 47 – 64 | 63 - 69 | 3.5 - 11.0 |
| | Split | 45 – 56 | 58 - 67 | 4.5 - 10.0 |
| Full-Size Car | Series | 48 – 50 | 61 - 65 | 6.5 - 12.5 |
| | Parallel | 43 – 46 | 56 - 58 | 5.0 - 9.0 |
| | Split | 44 – 46 | 57 - 67 | 6.0 - 10.5 |
| Mid-Size SUV | Series | 44 – 46 | 57 - 61 | 9.5 - 13.0 |
| | Parallel | 44 – 64 | 59 - 62 | 6.5 - 8.0 |
| | Split | 47 – 65 | 65 - 70 | 6.0 - 14.0 |
| Full-Size SUV | Series | 43 – 46 | 67 - 70 | 10.5 - 15.0 |
| | Parallel | 49 – 68 | 59 - 65 | 6.0 - 15.0 |
| | Split | 46 – 54 | 70 - 80 | 8.5 - 17.0 |

In addition, this study also shows the insignificant effect of engine sizing over the powertrain design for a PHEV due to required vehicle performance set by PNGV standards that need to be met by all the automakers. This result will allow the vehicle

powertrain designer to consider one less variable during vehicle design operation. In addition, Figure 67 shows that the ranking among the vehicle powertrain architecture (VPA) doesn't change (Split > Series > Parallel) but as long as the vehicle mass or sizes are increasing the difference of operational cost in between the Parallel and Series VPA are diminishing.

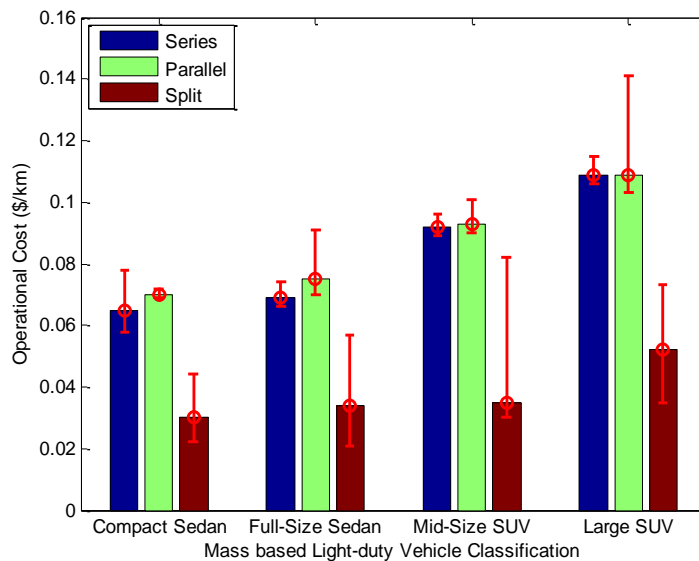

Figure 67 Comparative operational cost analysis over different light-duty vehicles

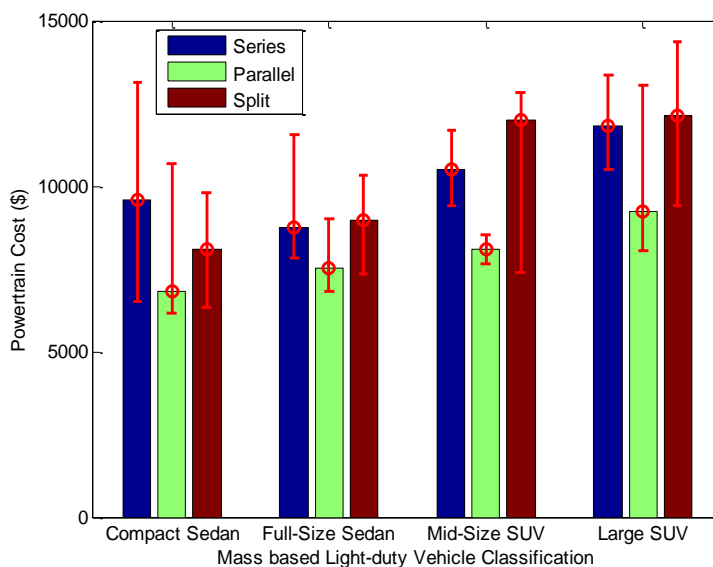

Figure 68 Comparative powertrain cost analysis over various light-duty vehicles

All of these costs are equivalent to other recent studies associated with PHEV incremental manufacturing costs, and as in other recent PHEV studies, the PHEV technology is estimated to be applicable to all vehicles in the vehicle fleet [120], [121].

6.3.2 Single Platform with Multiple Electric Drivelines

To develop a realistic computational model in order to observe diversity across consumers and the subsequent influence over the powertrain component sizing, the distribution of driving profiles are established through empirical data.

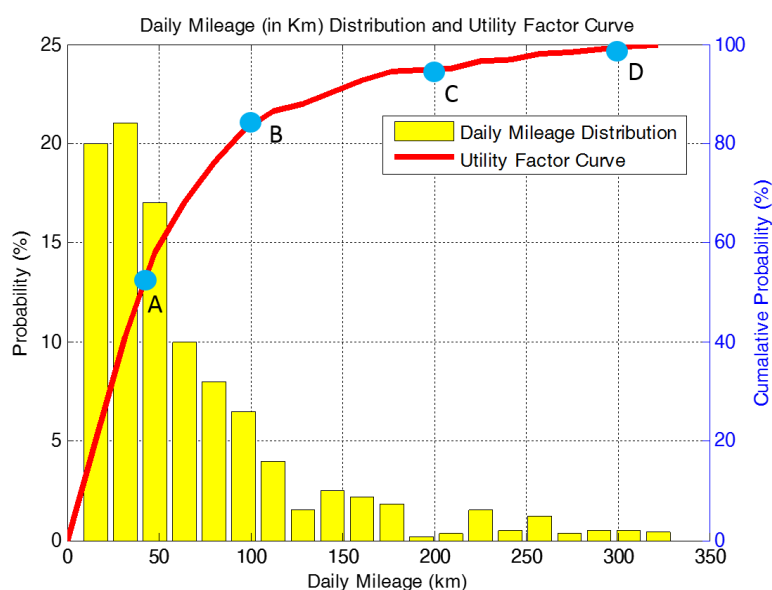

Figure 69 User classification with respect to daily driving distance [80], [122]

Moreover, if a consumer is thinking about buying a new hybrid, plug-in or a battery electric vehicle but is unaware of the technology and which one is going to suit them, then the following scenarios might be helpful for them to realize which type of vehicle technology would be beneficial for them based on their requirements and lifestyle. To develop these usage scenarios, the daily driving patterns and the utility factors generated from the data of the national household travel survey of Canada, which represents

comprehensive mobility behaviors of more than 150,000 households and 300,000 people [122] is utilized as preliminary source of data (shown in Figure 69).

Transport Canada in 2010 produced a comprehensive study among HEV, PHEV and EVs where the necessity and demand of electric vehicle have been introduced to the general public with a consumer based scenario model. With a numerous combinations of powertrain components (engine, motor and battery) size over all possible powertrain architecture (split, series, and parallel) are being studied to observe the effect of driveline electrification over a single platform and the powertrain component sizing to accommodate the consumer's acceptability. Only the Split PHEV is discussed as it has been found to be most promising VPA among all the available architectures and project time constraints.

In order to classify and optimize a single vehicle platform into 3 possible electrified drivetrain classes (like, HEV, PHEV and BEV) to meet the requirements of consumer diversity, multiobjective optimization is carried over the compact sedan with split VPA (see Section 6.3.1) to evaluate Pareto front optimal solutions. Then, based on the total cost of ownership model, best design points are selected from the Pareto front for each type of electrified drivetrain architecture to serve each user class. After that, a parametric study is conducted by varying vehicle powertrain components. To reduce the level of complexity, the split VPA is selected and the size of the internal combustion engine is considered to be constant at 55 kW rated power to minimize GHG emission, follow the trace of drive cycles and fulfill required vehicle acceleration and gradeability performances mentioned earlier in Chapter 5 in Section 5.2.3 (see page 56). Both battery and electric motor are varied (see page 123 – 125 in Appendix C) in order to make the

vehicle configuration acceptable for consumers in terms of cost savings during vehicle lifetime, all-electric range and fuel economy.

Based on the report of Transport Canada [123] and large automakers proposed drivelines (such as Tesla Model S, Ford C-max, etc.), consumers or scenarios are classified into 4 different representative classes based on their daily travel nature (also shown in Figure 69):

- **Class A:** It is assumed that the user is a young personal who lives with their spouse in the urban region. Usually, they use public transport to reach their workplace due to lack of parking facility in their workplace and to avoid traffic congestion, but they use the car for grocery shopping and visiting families & friends inside the city. Moreover, they drive less than 50 km a day and would like to buy a new vehicle that gets good mileage in the urban driving condition and is also environmentally cleaner.

Table 13 Vehicle choice scenario for Class A user based on lifetime savings

| Vehicle Choice | Powertrain Costs | Fuel Costs | Fuel Consumption | Electric Range | Savings |
|----------------|------------------|------------|------------------|----------------|----------|
| CV | \$ 1,084 | \$ 1,601 | 6.75 L/100km | - | - |
| PHEV | \$ 5,808 | \$ 404 | 4.15 L/100km | 52 km | \$ 7,254 |
| BEV | \$ 5,948 | \$ 252 | - | 72 km | \$ 8,634 |

(Based on driving $50 \times 365 = 18,250$ km/year, gasoline at \$1.30/L and electricity at 10¢/kWh)

| Vehicle Choice | Engine Size | Motor Size | Battery Size |
|----------------|-------------|------------|--------------|
| CV | 55 kW | - | - |
| PHEV | 55 kW | 54 kW | 10 kWh |
| BEV | - | 55 kW | 7 kWh |

According to their requirements either a PHEV or BEV would be the optimal solution. Even though they cost initially more than a gasoline car (according to Appendix C - Table 18 and Table 19), they offer quite a savings during operation,

particularly in the urban driving condition. When driving around the city they could use electric mode, which would save lots of money. They could charge their vehicle in their apartment building and also it would be less harmful to the environment.

- **Class B:** This type of user is quite similar to Class A except either they have children whom they need to drop-off/pick-up along the way to the workplace or their home to workplace distance is comparatively longer. Therefore, they mostly drive in the city throughout weekdays for either going to the workplace or shopping daily goods and on the highway on the weekend to stopover friends and families living outside the city. In the city, they drive less than 50 km and on the weekend they drive up to 100 km a day.

Table 14 Vehicle choice scenario for Class B user based on lifetime savings

| Vehicle Choice | Powertrain Costs | Fuel Costs | Fuel Consumption | Electric Range | Savings |
|----------------|------------------|------------|------------------|----------------|----------|
| CV | \$ 1,084 | \$ 1,755 | 6.75 L/100km | - | - |
| PHEV | \$ 8,287 | \$ 296 | 4.23 L//100km | 102 km | \$ 7,390 |
| BEV | \$ 7,562 | \$ 281 | - | 106 km | \$ 8,259 |

(Based on driving 20,000 km/year, gasoline at \$1.30/L and electricity at 10¢/kWh)

| Vehicle Choice | Engine Size | Motor Size | Battery Size |
|----------------|-------------|------------|--------------|
| CV | 55 kW | - | - |
| PHEV | 55 kW | 55 kW | 15 kWh |
| BEV | - | 55 kW | 15 kWh |

They are looking to buy a new vehicle that gets good mileage in both the city and highway driving condition and also environmentally cleaner. According to their requirements either a PHEV or BEV with higher AER range would be an optimal solution. Even though they cost more than gasoline cars in terms of initial investment (according to Appendix C - Table 18 and Table 19).

- **Class C:** Class C is likely to be similar to Class B except on holidays, they drive beyond 300 kilometers in a day. If they are looking for a new vehicle with same types of requirements and also want to go on long trips without worrying about plugging on the grid along the way. Based on Appendix C, either an HEV or PHEV would be better transportation solution for them.

Table 15 Vehicle choice scenario for Class C user based on lifetime savings

| Vehicle Choice | Powertrain Costs | Fuel Costs | Fuel Consumption | Electric Range | Savings |
|----------------|------------------|------------|------------------|----------------|----------|
| CV | \$ 1,084 | \$ 1,755 | 6.75 L/100km | - | - |
| PHEV | \$ 6,441 | \$ 289 | 4.15 L/100km | 65 km | \$ 9,305 |
| HEV | \$ 4,341 | \$ 1,061 | 4.08 L/100km | - | \$ 3,681 |

(Based on driving 20,000 km/year, gasoline at \$1.30/L and electricity at 10¢/kWh)

| Vehicle Choice | Engine Size | Motor Size | Battery Size |
|----------------|-------------|------------|--------------|
| CV | 55 kW | - | - |
| PHEV | 55 kW | 55 kW | 9 kWh |
| HEV | 55 kW | 70 kW | 2 kWh |

- **Class D:** This type of user, drives roughly 20 km and mostly in town. They live not far off from their workplace and drives to the workplace as parking is complimentary. Moreover, they need to drop their kids off either at daycare or school along the way. Since, they drive mostly around the city, they find themselves in frequent stop-and-go traffic. They also occasionally go away on weekends with family and friends, but they use their partner's car for these trips that lead up to 200 km. If they are looking for having one car instead of two so that they can easily get around town but will still save money at the gas pump. Based on their requirements, a BEV with higher electric range to serve the longer trips or a PHEV with shorter range to overcome the daily

home to workplace route would be reasonable solution even though they need to spend more in the initial stage.

Table 16 Vehicle choice scenario for Class D user based on lifetime savings

| Vehicle Choice | Powertrain Costs | Fuel Costs | Fuel Consumption | Electric Range | Savings |
|----------------|------------------|------------|------------------|----------------|----------|
| CV | \$ 1,084 | \$ 1,755 | 6.75 L/100km | - | - |
| PHEV | \$ 4,595 | \$ 750 | 4.12 L//100km | 26 km | \$ 6,535 |
| BEV | \$ 12,473 | \$ 295 | - | 203 km | \$ 3,215 |

(Based on driving 20,000 km/year, gasoline at \$1.30/L and electricity at 10¢/kWh)

| Vehicle Choice | Engine Size | Motor Size | Battery Size |
|----------------|-------------|------------|--------------|
| CV | 55 kW | - | - |
| PHEV | 55 kW | 55 kW | 4 kWh |
| BEV | | 55 kW | 30 kWh |

Based on the consumers requirements, driving patterns and concerns regarding the environment, it has been observed that there is an existence of diversity in powertrain configurations while purchasing a vehicle to satisfy their necessities. But, overall results are show 3 major categories. Those are mentioned in the following:

- (i) If the daily driving distances are comparatively short up to 100 km, then BEVs becomes the most beneficial transportation medium in the longer run due to their lower operational cost with respect to both CV and PHEV. This scenario is clearly visible in user type Class A and Class B. In addition, the ranking of vehicle selection: BEV > PHEV > CV > HEV
- (ii) If the driving distances becoming longer (100 km to 200 kms (like Class D) then PHEVs would be a better choice in terms of total life cycle cost as BEV becoming more expensive compared to other available options. However, the ranking of vehicle selection would be PHEV > BEV > CV > HEV

(iii) Nevertheless as long as the daily mileages increases (like Class C), BEVs become less effective due to their ultimately limited ad capital costs due to ever larger batteries. In this cases both PHEV and HEV becoming cost-effective solutions. The choice rank would be: PHEV > HEV > CV > BEV

The following is the summary of vehicle configuration selection among the user classifications:

Table 17 Comparison among PHEV family optimum configurations

| Plug-in Hybrid Electric Vehicle (PHEV) | | | | | |
|---|------------------|----------|--------|-------|---------|
| User Type | Weekdays | Weekends | Engine | Motor | Battery |
| Class A | 50 km | 50 km | | | 11 kWh |
| Class B | 50 km | 100 km | 55 kW | 55 kW | 11 kWh |
| Class C | 50 km | 300 km + | | | 9 kWh |
| Class D | less than 200 km | | | | 4 kWh |
| Battery Electric Vehicle (BEV) | | | | | |
| User Type | Weekdays | Weekends | Engine | Motor | Battery |
| Class A | 50 km | 50 km | | | 10 kWh |
| Class B | 50 km | 100 km | - | 55 kW | 15 kWh |
| Class C | 50 km | 300 km + | | | - |
| Class D | less than 200 km | | | | 30 kWh |
| Hybrid Electric Vehicle (HEV) | | | | | |
| User Type | Weekdays | Weekends | Engine | Motor | Battery |
| Class A | 50 km | 50 km | - | - | - |
| Class B | 50 km | 100 km | - | - | - |
| Class C | 50 km | 300 km + | 55 kW | 70 kW | 2 kWh |
| Class D | less than 200 km | | | | - |

According to the parametric study results (Appendix C) and Table 17, it becomes clear that if automakers would like to offer a single platform with multiple powertrain architectures through varying powertrain components, then it is viable to keep engine size constant and vary either electric motor (to vary vehicle acceleration or gradability performance) and battery (to vary fuel economy or all-electric range) sizes to accommodate

customer requirements. It is also found that the motor size needs to be large (at least 70 kW or more) in highway driving in order to meet required driving acceleration requirements, whereas 55 kW to 70 kW is adequate for frequent stop-and-go conditions (city driving). Moreover, the optimum capacity for a battery is about 4 to 12 kWh for PHEV, 10 to 30 kWh for BEV and up to 2 kWh for HEV if the manufacturer is considering to keep the manufacturing cost lower enough to make the transportation market competitive for PHEVs.

Chapter 7: Conclusions and Future Work

In this final chapter, the conclusion and recommendations for future work regarding the multi-objective optimization of Plug-in Hybrid Electric Vehicle (PHEV) will be presented.

7.1 Conclusions

The key contribution of this research was the development of a methodological approach for multi-objective optimization (MOO) in order to perform concurrent optimization of plug-in hybrid electric vehicles (PHEVs) where all the major powertrain components were optimized concerning design objectives and performance constraints within the optimization routine. Furthermore, a non-gradient and non-dominated sorting multi-objective genetic algorithm with Pareto search technique was applied to reduce simulation run-time of the optimization process.

A split plug-in hybrid electric vehicle (PHEV) with powertrain components close to those of 2012 Toyota Prius was developed using the combined backward-forward looking architecture through the model based system design feature of ADVISOR/SIMULINK. To demonstrate the effectiveness of the proposed optimization and design process, the powertrain components, and power management logic were simultaneously optimized to determine the most effective control strategy for all the available powertrain architectures like, split, series or parallel. The parameters for the power management logic included the battery's state of charge (SOC) threshold, the SOC below which engine should be turned on to restore battery charge, and also engine speed and torque, for which the genset

should be operating at the most efficient point. The design variables for this study are the major powertrain components (engine, battery and electric motor/generator). The objective function of the optimizer was defined from the financial perspective, where the objectives were to minimize the sum of initial cost of powertrain components and also to reduce the energy consumption (fuel and electricity) cost over a period of 15 years (which is considered to be nominal vehicle lifetime). However, the vehicle performance constraints were developed based on PNGV standards and the optimization process performed over different driving patterns (such as city – UDDS and highway – HWFET). The vehicle simulation process continued until it reached to a certain level of battery state of charge (SOC) which is assumed to be 20%.

Furthermore, this research presented an integrated study of technical, cost prospective, and future potentiality of PHEV relative to CV and equivalent HEV technology that are already available in the Canadian transportation market. A comparison among CV, HEV and PHEV were carried out to minimize the cost associated with lifetime in terms of operational and powertrain cost, and so on as gasoline consumption. It has been found that some vehicle powertrain architectural designs optimized over one drive cycle behave differently over other drive cycles. The impacts of uncertainty associated with the cost model, specifically from the dissimilarities in the future powertrain components, electricity and fuel retail prices, were taken into account to consider the various pricing conditions with respect to baseline what's deemed to be current or short-term pricing scenario. In order to determine the robustness and uncertainty of current technical assumptions for the simplified TCO model, as a sensitivity and breakeven point analysis were executed and also identified which components or parameters associated with cost

were the most influential. The outcomes of the simulation revealed that the anticipated approach is representing productive process to reduce powertrain cost compared to baseline CV vehicle platform.

7.2 Contribution of Thesis Work

Overall, based on the research studies confined space, the current manufacturing cost, assumptions regarding this vehicle attributes (i.e.: powertrain components, control strategy etc.) and the validation model provided for Toyota Prius by ANL, the overall analysis showed that:

- PHEV powertrains have better fuel economy than ICEVs with the same vehicle platform even though additional powertrain components such as the ESS increased the overall vehicle weight and cost
- The ranking of PHEV powertrains after optimization of powertrain components of PHEV are Split > Parallel > Series; the sensitivity analysis shown that if the manufacturing cost of the battery reduced then there is a possibility of shifting the competitiveness among the various HEV powertrain architecture into Split > Series > Parallel.
- Driving patterns have a great impact over the PHEV fuel economy when PHEVs are optimized based on city driving conditions they are able to fulfill all the performance constraints even running in the highway scenario. However, optimization of the highway cycle for the Series PHEV fails to satisfy the performance requirements during the city driving cycle, which indicates that it's wise to

optimize powertrain components either based on city driving conditions or combined city and highway.

- Based on current pricing assumptions and available technology, the split PHEV is the most cost-efficient VPA for both the urban and highway driving patterns.
- The total cost of ownership (TCO) formula of the plug-in hybrid electric vehicle is quite sensitive to numerous factors. In particular, gasoline price, electricity price, battery costs, discount rate, and driving habits (annual mileage, vehicle lifetime) have significant impacts on the relative value of PHEVs.
- All the Split PHEVs can save consumers money within the vehicle lifetime, and the TCO is comparatively lower than CV or HEV to become the favorable electrification scenario. Although, under all the considered assumptions, it would take at least 4 to 5 years before the PHEVs become economically superior to CV
- An increase of greater than 200% (\$0.2/kWh, reasonable) increase of electricity and 50-70% (\$0.7/L, unreasonable) decrease of gas price could make ICEV beneficial otherwise the lower operational cost will always make PHEVs as the better alternatives even though the initial investment is higher
- The future prospective of PHEVs is high enough to be considered as the alternative cleaner solution in reducing per-vehicle gasoline consumptions. To reduce gasoline consumption over 50%, the focus has to be over PHEV with $AER \geq 20$. This compares favorably with the 40% maximum reduction estimated for HEVs. Hence, it

seems likely that the added battery capacity of a PHEV will result in significant vehicle cost increments, even in the long term.

- The ranking among the light-duty PHEV powertrain architecture (VPA) doesn't change (Split > Series > Parallel) but as long as the vehicle mass or sizes are increasing (Compact Sedan < Full-size Sedan < Mid-size SUV < Large SUV) the difference of operational cost in between the Parallel and Series VPA are diminishing.
- A way to set out the features and benefits of hybridization of vehicle propulsion system (such as HEV, PHEV, and EVs) is also proposed through several scenarios based on the consumers driving patterns. That shows if the range of daily driving is within 200 km range, it would be beneficial to utilize either EV or PHEVs as they possess all electric mode that doesn't need any gasoline consumption; otherwise, HEV would be much more beneficial due to its better fuel-economy and non-plugging nature.
- A PHEV sized on the basis of aggressive driving cycles requires larger and more expensive electric components but offers AER operations, the benefits of which include qualifying for greater credits toward satisfying CARB 's ZEV regulation and a smoother-driving quality

7.3 Limitations and Future Work

There are numerous factors that have influence over the vehicle powertrain cost, lifetime cost, fuel consumption, and GHG emissions. In this study, the driving patterns, powertrain component sizing and manufacturing cost of powertrain components has been

addressed. However, the climate has significant influences on electric powertrain in terms of efficiency, fuel consumption and state of charge of battery packs due to thermal management of ESS, climate control (air conditioning and heating), and temperature sensitivities of battery degradation. Moreover, the topography and road gradient also has influence over the electrified drivetrain and it varies design to design based on how the powertrain components are interlinked, although the drive cycles presented here are on flat ground.

The selection process of vehicle design could also impact the outcomes. The PHEVs without blended operation mode are considered for this study in order reduce complexity and not make the outcomes too dependent on the assumptions. Here, only UDDS and HWFET are used as driving cycles which are usually applied for determining corporate average fuel economy (CAFÉ) tests that could underestimate relative cost, fuel consumption and GHG benefits of HEVs or PHEVs. To make a PHEV most efficient, proper energy management among the various power elements are required. This task is performed by a control strategy that could be refined in future studies.

Future research study will be carried out with a view to:

- integration of large variety of drive cycles including more aggressive and real-world scenarios (e.g. US06, NYC, LA92, etc.)
- inclusion of green-house-gas (GHG) emissions as either objective function or as design constraints through carbon-tax
- emphasis on the simultaneous selection of component sizes and control strategy parameters

- optimization of Fuel Cell Hybrid Electric Vehicle (FC-HEV) and Electric Vehicles (EV) over multiple drive cycles with the integration of a utility curve weighting

Bibliography

- [1] S. Golbuff, "Optimization of a plug-in hybrid electric vehicle," *Mech. Eng.*, no. August, 2006.
- [2] S. Golbuff, "Design Optimization of a Plug-In Hybrid Electric Vehicle," in *SAE Technical Paper*, 2007.
- [3] R. D. Strattan, "The electrifying future of the hybrid automobile," *IEEE Potentials*, vol. 23, no. 3. pp. 4–7, 2004.
- [4] U. S. D. of Energy, "Total Energy: Monthly Energy Review," 2014.
- [5] U. S. D. of Energy, "Transportation Energy Data Book," 2014.
- [6] B. Berman, "The Top Ten Hybrid Myths," *Bus. Week Online*, p. 12, 2006.
- [7] E. Canada, "National Inventory Report 1990-2012," 2014.
- [8] J. J. M. C.-S. N. S. Scott B. Peterson, "Optimal Plug-in Hybrid Vehicle Design and Allocation for Minimum Life Cycle Cost, Petroleum Consumption and Greenhouse Gas Emissions," *ASME Int. Des. Eng. Tech. Conf. Comput. Inf. Eng. Conf.*, vol. 4, no. 12, pp. 183–195, 2010.
- [9] C.-S. N. Shiau, N. Kaushal, C. T. Hendrickson, S. B. Peterson, J. F. Whitacre, and J. J. Michalek, "Optimal Plug-In Hybrid Electric Vehicle Design and Allocation for Minimum Life Cycle Cost, Petroleum Consumption, and Greenhouse Gas Emissions," *Journal of Mechanical Design*, vol. 132, no. 9. p. 091013, 2010.
- [10] B. M. Al-alawi and T. H. Bradley, "Total cost of ownership , payback , and consumer preference modeling of plug-in hybrid electric vehicles," vol. 103, no. 2013, pp. 488–506, 2014.
- [11] K. S. Toyota, "Toyota's Strategy for Environmental Technologies," 2015. [Online]. Available: <http://www.kenshawtoyota.ca/en/about/p/toyotas-strategy-for-environmental-technologies/>.
- [12] E. P. R. Institute, "Comparing the Benefits and Impacts of Hybrid Electric Vehicle Options," Palo Alto, CA, 2001.
- [13] E. P. R. Institute, "Comparing the Benefits and Impacts of Hybrid Electric Vehicle Options for Compact Sedan and Sport Utility Vehicles," Palo Alto, CA, 2002.

- [14] D. L. Greene and J. DeCicco, "Engineering-Economic Analyses of Automotive Fuel Economy Potential in the United States," *Annual Review of Energy and the Environment*, vol. 25, no. 1. pp. 477–535, 2000.
- [15] D. Lemoine, D. Kammen, and A. Farrell, "Effects of Plug-In Hybrid Electric Vehicles in California Energy Markets," in *Annual Meeting of the Transportation Research Board*, 2007.
- [16] J. H. S. Plotkin, D. Santini, A. Vyas, J. Anderson, M. Wang, D. Bharathan, "Hybrid Electric Vehicle Technology Assessment: Methodology Analytical Issues, and Interim Results," *Argonne Natl. Lab.*, 2002.
- [17] C. S. N. Shiau, C. Samaras, R. Hauffe, and J. J. Michalek, "Impact of battery weight and charging patterns on the economic and environmental benefits of plug-in hybrid vehicles," *Energy Policy*, vol. 37, no. 7, pp. 2653–2663, 2009.
- [18] A. Simpson, "Cost-Benefit Analysis of Plug-In Hybrid Electric Vehicle Technology," *Int. Batter. Hybrid Fuel Cell Electr. Veh. Symp. Expo.*, vol. 22, 2006.
- [19] M. Sharma, R., Manzie, C., Bessede, M. J. Brear, and R. H. Crawford, "Conventional, hybrid and electric vehicles for Australian driving conditions – Part 1: Technical and financial analysis," *Elsevier Transp. Res. Part C*, vol. 25, pp. 238–249, 2012.
- [20] R. Sharma, M. Bessede, C. Manzie, M. Brear, and R. Crawford, "An economic and in-service emissions analysis of conventional, hybrid and electric vehicles for Australian driving conditions," *SAE Tech. Pap.*, pp. 291–298, 2012.
- [21] D. Adams, K. Feeney, and M. Yi, "Economic viability of electric vehicles in metropolitan New South Wales," no. May, pp. 1–16, 2010.
- [22] M. Åhman, "Government policy and the development of electric vehicles in Japan," *Energy Policy*, vol. 34, no. 4, pp. 433–443, 2006.
- [23] S. K. Shahi, "Hybridization and Multi-Objective Optimization of Plug-in Hybrid Electric Vehicles," 2010.
- [24] L. Brasington, "A Brief History of the Hybrid Vehicle," www.geocities.com/Tokyo/6774/hybrid.htm, 2005.
- [25] National Research Counsel, *Review of the Research Program of the Partnership for a New Generation of Vehicles*. National Academy Press, 2001.

- [26] U. of C. Scientists, “History of California’s Zero Emission Vehicle (ZEV) Program,” <http://www.ucsusa.org/clean-vehicles/california-and-western-states/californias-zero-emission-program.html>. .
- [27] P. Sharer, “Powertrain Systems Analysis Toolkit (PSAT),” *Argonne Natl. Lab.*, 2007.
- [28] K., M. Wipke, D. Cuddy, Bharathan, S., A. B. V. Johnson, A. Markel, S., and Sprik, “Advisor 2.0: A Second- Generation Advanced Vehicle Simulator for Systems Analysis,” *Natl. Renew. Energy Lab.*, 1999.
- [29] Autonomie, “<http://www.autonomie.net/>,” *Lab. Argonne Natl.*
- [30] G. ne. 2014, “<https://greet.es.anl.gov/>,” *Lab. Argonne Natl.*
- [31] S. K. Shahi and G. G. Wang, “Plug-In Hybrid Electric Vehicle Battery Selection for Optimum Economic and Environmental Benefits Using Pareto Set Points and PSATTM,” in *Volume 1: 36th Design Automation Conference, Parts A and B*, 2010, vol. 1, pp. 701–713.
- [32] T. P. Wu, Ji., Emadi, A., Duoba, M. J., and Bohn, “Plug-in hybrid electric vehicles: Testing, simulations, and analysis,” in *Electric Power and Power Electronics Centre, IEEE Vehicle Power and Propulsive Conference*, 2007, pp. 469–476.
- [33] M. Reynolds, C., and Kandlikar, “How hybrid-electric vehicles are different from conventional vehicles: The effect of weight and power on fuel consumption,” *Environ. Res. Lett.*, vol. 2, 2007.
- [34] C. Zervas, E., Lazarou, “Influence of European passenger cars weight to exhaust CO₂ emissions,” *Energy Policy*, vol. 36, pp. 248–257, 2008.
- [35] R. Graham, “Comparing the benefits and impacts of hybrid electric vehicle options,” Palo, Alto, CA, 2001.
- [36] J. Duoba, M., Carlson, R., and Wu, “Test procedures and benchmarking. Blendedtype and EV-capable plug-in hybrid electric vehicles.,” in *International Electric Vehicle Symposium (EVS23)*, 2007.
- [37] J. K. Aymeric Rousseau, Vincent Freyermuth, “Annual Progress Report for Advanced vehicle technology Analysis and Evaluation Activities,” 2007.
- [38] A. Rousseau, P. Sharer, and M. Pasquier, “Validation Process of a HEV System Analysis Model: PSAT,” in *SAE Technical Paper*, 2001.

- [39] X. Hu, Z. Wang, and L. Liao, "Multi-Objective Optimization of HEV Fuel Economy and Emissions using Evolutionary Computation," in *SAE Technical Paper*, 2004.
- [40] S. Golbuff, E. D. Kelly, and S. V. Shelton, "Cost Optimization of a Plug-In Hybrid Electric Vehicle," in *ASME 2008 2nd International Conference on Energy Sustainability, Volume 1*, 2008, pp. 497–505.
- [41] A. Karbowski, D. Haliburton, C., and Rousseau, "Impact of component size on plugin hybrid vehicle energy consumption using global optimization," *Int. Electr. Veh. Symp.*, vol. 23, 2007.
- [42] M. Fellini, R., Michelena, N., Papalambros, P., and Sasena, "Optimal Design of Automotive Hybrid Powertrain Systems," *Dep. Mech. Eng. Appl. Mech. Univ. Michigan*, 2007.
- [43] C. Desai, "Design and Optimization of Hybrid Electric Vehicle Drivetrain and Control Strategy Parameters Using Evolutionary Algorithms," Concordia University, 2010.
- [44] C. M. Wenzhong Gao, "Hybrid vehicle design using global optimisation algorithms," *Int. J. Electr. Hybrid Veh.*, vol. 1, no. 1, pp. 57–70, 2007.
- [45] V. J. Karplus, "Prospects for Plug-in Hybrid Electric Vehicles in the United States: A General Equilibrium Analysis," *Massachusetts Inst. Technol.*, 2008.
- [46] N. R. Council, "The hydrogen economy: Opportunities, costs, barriers, and R&D needs," *Washington, DC Natl. Acad. Press*, 2004.
- [47] J. M. Sandoval, R., Karplus, V.J., Paltsev, S., & Reilly, "Modeling the Prospects for Hydrogen Powered Transportation Through 2100," *Cambridge, MA MIT Jt. Progr. Sci. Policy Glob. Chang.*, 2008.
- [48] D. Anderman, M., Kalhammer, F.R., & MacArthur, "Advanced batteries for electric vehicles: An assessment of performance, cost, and availability," *Sacramento, CA State Calif. Air Resour. Board.*, 2000.
- [49] M. Duvall, "Advanced batteries for electric-drive vehicles: A technology and costeffectiveness assessment for batteryelectric vehicles, power-assist hybrid electric vehicles, and plug-in hybrid electric vehicles," *Electr. Power Res. Inst.*, 2008.
- [50] J. B. Kromer, M., Heywood, "Electric powertrains: Opportunities and challenges in the U.S. light-duty vehicle fleet," *MIT Lab. Energy Environ.*, 2007.
- [51] N. A. Press, *Transitions to Alternative Vehicles and Fuels*. 2013.

- [52] B. W. Kerrigan, "The Techno-economic Impacts of Using Wind Power and Plug-In Hybrid Electric Vehicles for Greenhouse Gas Mitigation in Canada," University of Victoria, 2010.
- [53] M. Hajian, M. Manickavasagam, W. D. Rosehart, and H. Zareipour, "Environmental Benefits of Using Wind Generation to Power Plug-in Hybrid Electric Vehicles," *Sch. Public Policy SPP Res. Pap.*, vol. 4, no. 9, pp. 1–12, 2011.
- [54] C. Samaras and K. Meisterling, "Life Cycle Assessment of Greenhouse Gas Emissions from Plug-in Hybrid Vehicles: Implications for Policy," *Environ. Sci. Technol.*, vol. 42, no. 9, pp. 3170–3176, May 2008.
- [55] H. Lund, "06/00886 Large-scale integration of wind power into different energy systems," *Fuel and Energy Abstracts*, vol. 47, no. 2. p. 130, 2006.
- [56] N. R. Canada, "2014 Fuel Consumption Guide," 2014.
- [57] F. Wikipedia, "Hybrid Vehicle Drivetrain," https://en.wikipedia.org/wiki/Hybrid_vehicle_drivetrain. .
- [58] Toyota, "Revealed Toyota Prius Hybrid Plug-in best hybrid car," <http://talkbestcar.blogspot.ca/2011/09/revealed-toyota-prius-hybrid-plug-in.html>, 2014. .
- [59] C. T. John, "Working Of Electric Cars," <http://www.circuitstoday.com/working-of-electric-cars>, 2010. .
- [60] E. Stromberg, "Optimal Control of Hybrid Electric Vehicles," *Link • opings Univ.*, 2003.
- [61] N. X. C. J. Wu, C. H. Zhang, "PSO algorithm-based parameter optimization for HEV powertrain and its control strategy," *Int. J. Automot. Technol.*, vol. 9, no. 1, pp. 53–59, 2008.
- [62] M. M. Gh and M. M. K, "Investigation of the energy management and powertrain systems effects on hybrid vehicle performance," *Int. J. Electr. Hybrid Veh.*, vol. 7, no. 1, pp. 40–61, 2015.
- [63] Y. L. Murphey, Jungme Park, Zhihang Chen, M. L. Kuang, M. A. Masrur, and A. M. Phillips, "Intelligent Hybrid Vehicle Power Control—Part I: Machine Learning of Optimal Vehicle Power," *IEEE Trans. Veh. Technol.*, vol. 61, no. 8, pp. 3519–3530, Oct. 2012.
- [64] M. Ghanaatian and A. Radan, "Application and simulation of dual-mechanical-port machine in hybrid electric vehicles," *Int. Trans. Electr. Energy Syst.*, vol. 25, no. 6, pp. 1083–1099, Jun. 2015.

- [65] International Energy Agency (IEA), “World Energy Outlook,” <https://www.iea.org/publications/freepublications/publication/weo2009.pdf>, 2009.
- [66] R. D. Senger, “Validation of ADVISOR as a Simulation Tool for a Series Hybrid Electric Vehicle Using the Virginia Tech FutureCar Lumina,” Virginia Polytechnic Institute and State University, 1998.
- [67] K. K. Markel, T. A. Brooker, T. Hendricks, V. Johnson and K. W. B. Kramer, M. O’Keefe, S. Sprik, “ADVISOR: a systems analysis tool for advanced vehicle modeling,” *J. Power Sources*, pp. 255–266, 2002.
- [68] Toyota, “2012 Prius Plug-in Hybrid Product Information,” http://www.motortrend.com/cars/2012/toyota/prius_plug_in/specifications/, 2012.
- [69] J. L. James Larminie, “Types of Electric Vehicles - EV Architecture,” in *Electric Vehicle Technology Explained*, Chichester, UK: John Wiley & Sons, Ltd, 2012, pp. 19–27.
- [70] B. Huang, Z. Wang, and Y. Xu, “Multi-Objective Genetic Algorithm for Hybrid Electric Vehicle Parameter Optimization,” in *2006 IEEE/RSJ International Conference on Intelligent Robots and Systems*, 2006, pp. 5177–5182.
- [71] “<http://www.energypolicy.co.uk/>,” *Energy Policy UK*.
- [72] and B. T. A. Staunton, R. H., Ayers, C.W., Marilo, L.D., Chiasson, J.N., “Evaluation of 2004 Toyota Prius hybrid electric drive system,” 2006.
- [73] B. S. Fan, A. Khajepour, and M. Kazerani, “Fuel Efficiency Comparison Between a Conventional and a Hybrid Vehicle Using a Model Based on MATLAB/Simulink and ADAMS,” in *Volume 5: 13th Design for Manufacturability and the Lifecycle Conference; 5th Symposium on International Design and Design Education; 10th International Conference on Advanced Vehicle and Tire Technologies*, 2008, pp. 855–863.
- [74] Bufu Huang, Xi Shi, and Yangsheng Xu, “Parameter Optimization of Power Control Strategy for Series Hybrid Electric Vehicle,” in *2006 IEEE International Conference on Evolutionary Computation*, pp. 1989–1994.
- [75] V. Freyermuth, E. Fallas, and A. Rousseau, “Comparison of Powertrain Configuration for Plug-in HEVs from a Fuel Economy Perspective,” *SAE Int. J. Engines*, vol. 1, no. 1, pp. 2008–01–0461, Apr. 2008.
- [76] A. R. Dominik Karbowski, “Plug-in Vehicle Control Strategy: From Global Optimization to Real-time Application,” *Argonne Natl. Lab.*, 2007.

- [77] S. of A. Engineers, “Recommended Practice for Measuring the Exhaust Emissions and Fuel Economy of Hybrid-Electric Vehicles,” 1999.
- [78] T. H. Bradley and C. W. Quinn, “Analysis of plug-in hybrid electric vehicle utility factors,” *J. Power Sources*, vol. 195, no. 16, pp. 5399–5408, Aug. 2010.
- [79] S. of A. Engineers, “Utility Factor Definitions for Plug-In Hybrid Electric Vehicles Using 2001 U.S. DOT National Household Travel Survey Data,” 2009.
- [80] M. Turcotte, “Commuting to work: Results of the 2010 General Social Survey,” *Stat. Canada*, 2011.
- [81] A. Rousseau, “Validation of the Hymotion Prius PHEV,” *Adv. Veh. Technol. Anal. Eval. Act.*, pp. 22–27, 2007.
- [82] A. N. Laboratory, “<http://www.anl.gov/>.” .
- [83] EPRI, “Advanced Batteries for Electric-Drive Vehicles: A Technology and Cost-Effectiveness Assessment for Battery Electric Vehicles, Power Assist Hybrid Electric Vehicles, and Plug-In Hybrid Electric Vehicles,” 2004.
- [84] P. Adelhelm, P. Hartmann, C. L. Bender, M. Busche, C. Eufinger, and J. Janek, “From lithium to sodium: cell chemistry of room temperature sodium–air and sodium–sulfur batteries,” *Beilstein J. Nanotechnol.*, vol. 6, pp. 1016–1055, Apr. 2015.
- [85] R. C. Balch, A. Burke, and A. A. Frank, “The affect of battery pack technology and size choices on hybrid electric vehicle performance and fuel economy,” in *Sixteenth Annual Battery Conference on Applications and Advances. Proceedings of the Conference (Cat. No.01TH8533)*, 2001, pp. 31–36.
- [86] T. Technologies, “Synthesis of High Capacity Sn/MOx Nano Composite Anode Materials for Lithium Rechargeable Batteries,” www.tjtechnologies/research/batteries, 2006. .
- [87] I. ThermoAnalytics, “BatteryTypes and Characteristics,” www.thermoanalytics.com/support/publications/batterytypesdoc.html, 2006. .
- [88] Altair Nanotechnologies, “Press Release: High Performance Li Ion Battery,” 2006. .
- [89] K. Smith, M. Earleywine, E. Wood, J. Neubauer, and A. Pesaran, “Comparison of Plug-In Hybrid Electric Vehicle Battery Life Across Geographies and Drive Cycles,” in *SAE Technical Paper*, 2012.

- [90] V. Marano, S. Onori, Y. Guezennec, G. Rizzoni, and N. Madella, "Lithium-ion batteries life estimation for plug-in hybrid electric vehicles," in *2009 IEEE Vehicle Power and Propulsion Conference*, 2009, pp. 536–543.
- [91] S. Canada, "Historical Gas Price Chart," <http://www.statcan.gc.ca/pub/11-402-x/2010000/chap/ener/tbl/tbl03-eng.htm>, 2012. .
- [92] C. E. Association, "Electricity Pricing: An Introduction to Canadian Electricity rates," <http://www.poweryourknowledge.com/rates.html>, 2011. .
- [93] J. P. Ribau, C. M. Silva, and J. M. C. Sousa, "Efficiency, cost and life cycle CO2 optimization of fuel cell hybrid and plug-in hybrid urban buses," *Appl. Energy*, vol. 129, pp. 320–335, Sep. 2014.
- [94] P. Melo, J. Ribau, and C. Silva, "Urban Bus Fleet Conversion to Hybrid Fuel Cell Optimal Powertrains," *Procedia - Soc. Behav. Sci.*, vol. 111, pp. 692–701, Feb. 2014.
- [95] T. C. Moore and A. B. Lovins, "Vehicle Design Strategies to Meet and Exceed PNGV Goals," in *SAE Technical Paper*, 1995.
- [96] X. Wu, B. Cao, X. Li, J. Xu, and X. Ren, "Component sizing optimization of plug-in hybrid electric vehicles," *Appl. Energy*, vol. 88, no. 3, pp. 799–804, Mar. 2011.
- [97] T. Wipke, K.; Markel, "Optimization Techniques for Hybrid Electric Vehicle Analysis Using ADVISOR," in *Proceedings of ASME, International Mechanical Engineering Congress and Exposition*, 2001.
- [98] M. Fellini, R.; Michelena, N.; Papalambros, P.; Sasena, "Optimal Design of Automotive Hybrid Powertrain Systems," in *Proceedings of First International Symposium On Environmentally Conscious Design and Inverse Manufacturing*, 1999.
- [99] N. Hansen, "Benchmarking the nelder-mead downhill simplex algorithm with many local restarts," *Proc. 11th Annu. Conf. companion Genet. Evol. Comput. Conf. - GECCO '09*, p. 2403, 2009.
- [100] Z. W. Z. Wang, B. H. B. Huang, W. L. W. Li, and Y. X. Y. Xu, "Particle Swarm Optimization for Operational Parameters of Series Hybrid Electric Vehicle," *2006 IEEE Int. Conf. Robot. Biomimetics*, 2006.
- [101] Xiaolan Wu, Binggang Cao, Jianping Wen, and Yansheng Bian, "Particle swarm optimization for plug-in hybrid electric vehicle control strategy parameter," in *2008 IEEE Vehicle Power and Propulsion Conference*, 2008, pp. 1–5.

- [102] A. Piccolo, L. Ippolito, V. zo Galdi, and A. Vaccaro, "Optimisation of energy flow management in hybrid electric vehicles via genetic algorithms," *2001 IEEE/ASME Int. Conf. Adv. Intell. Mechatronics. Proc. (Cat. No.01TH8556)*, vol. 1, 2001.
- [103] J. Chen, Y. Li, and J. Wang, "Simultaneous optimization of fuel consumption and emissions for a parallel hybrid electric SUV using fuzzy logic control," *Int. J. Veh. Des.*, 2008.
- [104] M. Montazeri-Gh, A. Poursamad, and B. Ghalichi, "Application of genetic algorithm for optimization of control strategy in parallel hybrid electric vehicles," *J. Franklin Inst.*, vol. 343, no. 4–5, pp. 420–435, Jul. 2006.
- [105] L. Fang, S. Qin, G. Xu, T. Li, and K. Zhu, "Simultaneous Optimization for Hybrid Electric Vehicle Parameters Based on Multi-Objective Genetic Algorithms," *Energies*, vol. 4, no. 12, pp. 532–544, Mar. 2011.
- [106] R. Cook, A. Molina-Cristobal, G. Parks, C. Osornio Correa, and P. J. Clarkson, "Multi-objective Optimisation of a Hybrid Electric Vehicle: Drive Train and Driving Strategy," in *Evolutionary Multi-Criterion Optimization*, Berlin, Heidelberg: Springer Berlin Heidelberg, 2007, pp. 330–345.
- [107] S. Hui, "Multi-objective optimization for hydraulic hybrid vehicle based on adaptive simulated annealing genetic algorithm," *Eng. Appl. Artif. Intell.*, vol. 23, no. 1, pp. 27–33, Feb. 2010.
- [108] X.-S. Y. Slawomir Koziel, "Computational Optimization, Methods and Algorithms," *Springer*, 2011.
- [109] C. A. Coello, "A Short Tutorial on Evolutionary Multiobjective Optimization," in *Evolutionary Multi-Criterion Optimization*, 2001, pp. 21–40.
- [110] K. Deb, A. Pratap, S. Agarwal, and T. Meyarivan, "A fast and elitist multiobjective genetic algorithm: NSGA-II," *IEEE Trans. Evol. Comput.*, vol. 6, no. 2, pp. 182–197, Apr. 2002.
- [111] J. P. Ribau, J. M. C. Sousa, and C. Silva, "Multi-Objective Optimization of Fuel Cell Hybrid Vehicle Powertrain Design - Cost and Energy," in *SAE Technical Paper*, 2013.
- [112] EPA, "Federal Test Procedure Revisions. Environmental Protection Agency," <http://www.epa.gov/oms/sftp.htm>, 1996. .
- [113] D. G. Aymeric Rousseau, Sylvain Pagerit, "Plug-in Hybrid Electric Vehicle Control Strategy Parameter Optimization," *Int. J. Electr. Hybrid Veh.*, vol. 1, no. 1, pp. 57–70, 2007.

- [114] M. Markel, T. Brooker, A. Gonder, J. O'Keefe, M. Simpson, A., and Thornton, "Plug-in hybrid vehicle analysis," *Natl. Renew. Energy Lab. Milestone Rep.*, vol. NREL/MP-54, 2006.
- [115] U. S. E. P. Agency, "Title 40—Protection of Environment, Section 600.315-82 Classes of comparable automobiles," 2011.
- [116] U. S. N. H. T. S. Administration, "5-Star Safety Ratings of," <http://www.safercar.gov/Vehicle+Shoppers/5-Star+FAQ>. .
- [117] Wikipedia, "Car classification," https://en.wikipedia.org/wiki/Car_classification#Crossover_SUV. .
- [118] and D. N. Keith Wipke, Tony Markel, "Optimizing Energy Management Strategy and Degree of Hybridization for a Hydrogen Fuel Cell SUV," *EVS*, vol. 18, 2001.
- [119] M. Z. Aaron Brooker, Kristina Haraldsson, Terry Hendricks, Valerie Johnson, Kenneth Kelly, Bill Kramer, Tony Markel, Michael O'Keefe, Sam Sprik, Keith Wipke, "ADVISOR Documentation," http://adv-vehicle-sim.sourceforge.net/advisor_doc.html, 2013. .
- [120] A. Moawad and A. Rousseau, "Impact of vehicle performance on cost effective way to meet CAFE 2017–2025," in *2011 IEEE Vehicle Power and Propulsion Conference*, 2011, pp. 1–8.
- [121] A. Moawad, G. Singh, S. Hagspiel, M. Fellah, and A. Rousseau, "Impact of Real World Drive Cycles on PHEV Fuel Efficiency and Cost for Different Powertrain and Battery Characteristics," *Int. Batter. Hybrid, Fuel Cell Electr. Veh. Symp.*, vol. EVS24, 2009.
- [122] M. Redelbach, E. D. Özdemir, and H. E. Friedrich, "Optimizing battery sizes of plug-in hybrid and extended range electric vehicles for different user types," *Energy Policy*, vol. 73, pp. 158–168, Oct. 2014.
- [123] T. Canada, "Electric Vehicle Primer," <https://www.tc.gc.ca/eng/programs/environment-etv-evprimer-eng-1994.htm>, 2010. .
- [124] H. Weisbaum, "What's the life expectancy of my car?," http://www.nbcnews.com/id/12040753/ns/business-consumer_news/t/whats-life-expectancy-my-car/#.VcbemvIviko, 2015.

Appendix A. Determination of All Electric Range (AER)

The all-electric range (AER) is defined as the distance the vehicle can travel on the UDDS until the first engine start. Note that a separate control algorithm is used to simulate the AER (also known as ZEV, shown in Figure 70). Here, in case of simulating PHEVs, this algorithm used to force the engine to remain off throughout the cycle, regardless of the torque request from the driver.

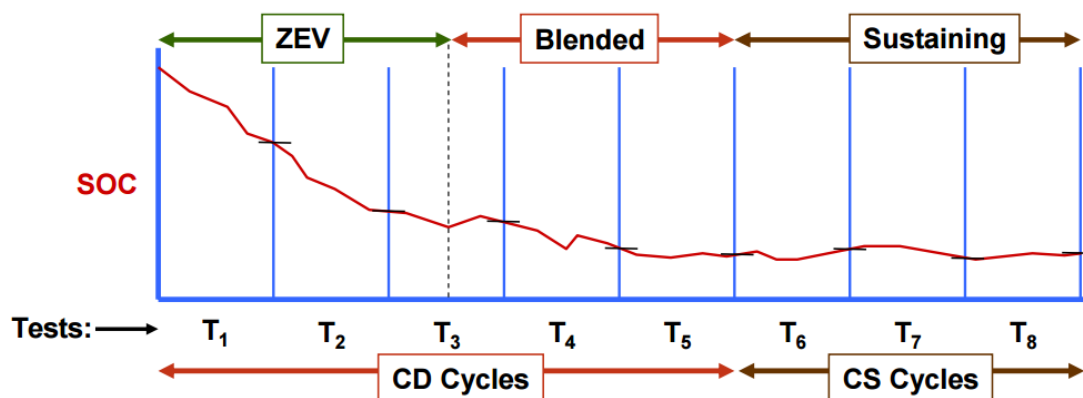

Figure 70 AER capable PHEV operating over a FCT

Appendix B. Aggressiveness of Drive Cycles

As per earlier discussion, driving cycles serve as a standardised measurement procedure for the certification of a vehicle's fuel economy, emissions and driving range. They also facilitate the evaluation of the economic and lifecycle costs of emerging vehicular technologies. However, discrepancies between existing driving cycles and real-world driving conditions exist due to a number of factors such as insufficient data, inadequate driving cycle development methodologies and methods to assess the representativeness of developed driving cycles. In order to reduce this discrepancies, the effect of drive cycle's aggressiveness are observed in this study. Here, the aggressiveness refers to the acceleration levels achieved, shown in Figure 71.

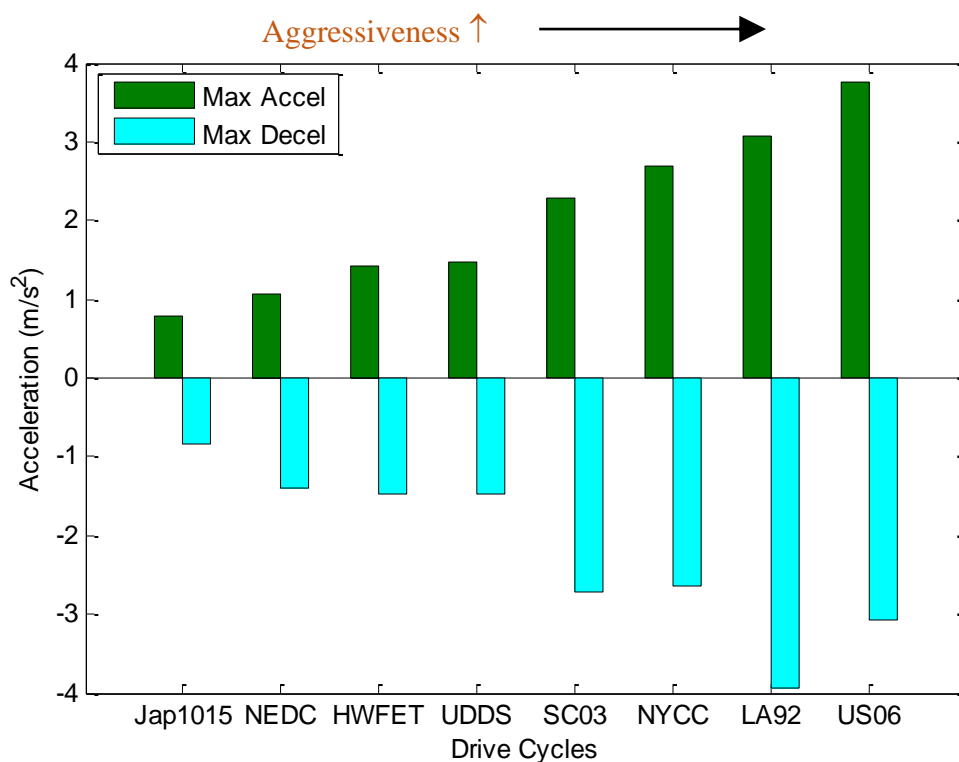

Figure 71 Aggressiveness of driving cycle

Appendix C. PHEV Family data for various Combination of Powertrain Components

Initially, a similar of multiobjective optimization was carried over the compact sedan category (see section 5.2.4 and section 6.3.1) to evaluate Pareto front optimal solutions. Then, based on the total cost of ownership model, best design points are selected from the Pareto front for each type of architecture to represent each user class. After that, a parametric study is conducted by varying vehicle powertrain components and tabulated all the outputs from the performance and cost models. To reduce the level of complexity, the split VPA is selected and the size of internal combustion engine is considered to be constant at 55 kW rated power based on:

- (1) earlier results of optimized engine size
- (2) to minimize green-house-gas (GHG) emission
- (3) fulfills required vehicle acceleration, and gradeability performances mentioned earlier in Chapter 5 in section 5.2.3 (see page 56).

On the other hand, both battery and electric motor are varied. The size of electric motors are considered within 55 to 100 kW, and the size of batter pack are considered within 2 to 7 kWh, 2 to 23 kWh and 10 to 100 kWh for HEV, PHEV and BEV respectively based on the vehicle available in the market or potential vehicle configuration that are being researched by several OEMs and automobile development associated firms or institutions.

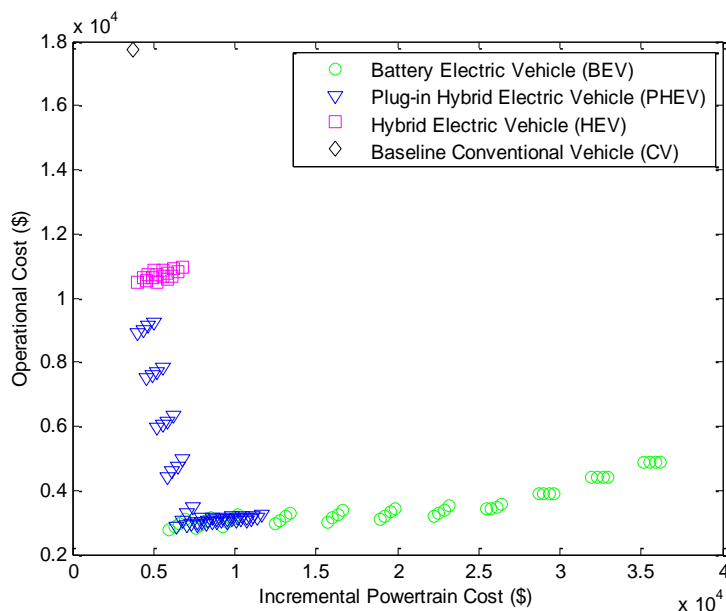

Figure 72 Powertrain vs. Operational cost of single platform of PHEV classes

Figure 72, Table 18, Table 19 and Table 20 illustrate all the vehicle powertrain combinations results that are considered for the parametric study mentioned in section 6.3.2.

Table 18 BEV family data for various combination of powertrain components⁷

| | Motor Power (kW) | | | | Motor Power (kW) | | | | Motor Power (kW) | | | | BEV |
|-----|--------------------------------|-----|-----|-----|-------------------------------|---------|---------|---------|---|----------|----------|----------|-----|
| | 55 | 70 | 85 | 100 | 55 | 70 | 85 | 100 | 55 | 70 | 85 | 100 | |
| 10 | 72 | 69 | 66 | 64 | \$2,758 | \$2,876 | \$2,981 | \$3,104 | \$5,948 | \$6,275 | \$6,602 | \$6,928 | |
| 15 | 106 | 101 | 97 | 94 | \$2,814 | \$2,935 | \$3,054 | \$3,166 | \$7,562 | \$7,888 | \$8,215 | \$8,542 | |
| 20 | 139 | 134 | 129 | 124 | \$2,875 | \$2,994 | \$3,105 | \$3,225 | \$9,245 | \$9,572 | \$9,899 | \$10,225 | |
| 30 | 203 | 196 | 189 | 181 | \$2,947 | \$3,058 | \$3,176 | \$3,302 | \$12,473 | \$12,799 | \$13,126 | \$13,452 | |
| 40 | 263 | 254 | 245 | 236 | \$3,029 | \$3,138 | \$3,254 | \$3,371 | \$15,700 | \$16,026 | \$16,353 | \$16,680 | |
| 50 | 321 | 310 | 299 | 289 | \$3,102 | \$3,212 | \$3,328 | \$3,445 | \$18,927 | \$19,253 | \$19,580 | \$19,907 | |
| 60 | 377 | 365 | 353 | 341 | \$3,174 | \$3,282 | \$3,397 | \$3,514 | \$22,224 | \$22,551 | \$22,877 | \$23,204 | |
| 70 | 410 | 410 | 403 | 390 | \$3,409 | \$3,409 | \$3,463 | \$3,581 | \$25,451 | \$25,778 | \$26,104 | \$26,431 | |
| 80 | 410 | 410 | 410 | 410 | \$3,893 | \$3,893 | \$3,893 | \$3,893 | \$28,678 | \$29,005 | \$29,331 | \$29,658 | |
| 90 | 410 | 410 | 410 | 410 | \$4,388 | \$4,388 | \$4,388 | \$4,388 | \$31,975 | \$32,302 | \$32,629 | \$32,955 | |
| 100 | 410 | 410 | 410 | 410 | \$4,872 | \$4,872 | \$4,872 | \$4,872 | \$35,202 | \$35,529 | \$35,856 | \$36,182 | |
| | All Electric Range (AER) in Km | | | | Operational Cost for 10 years | | | | Powertrain Cost w/o Battery Replacement | | | | |

⁷ All the costs mentioned in Table 18 is in Canadian dollar (\$CAD)

Table 19 PHEV family data for various combination of powertrain components⁸

| | | Motor Power (kW) | | | | Motor Power (kW) | | | | Motor Power (kW) | | | | |
|----------------------|----|--------------------------------|-----|-----|-----|-------------------------------------|----------|----------|----------|---|-----------|-----------|-----------|------------------|
| | | 55 | 70 | 85 | 100 | 55 | 70 | 85 | 100 | 55 | 70 | 85 | 100 | |
| Battery Energy (kWh) | 2 | 14 | 14 | 14 | 14 | \$ 8,910 | \$ 9,014 | \$ 9,120 | \$ 9,236 | \$ 4,014 | \$ 4,341 | \$ 4,668 | \$ 4,994 | P H E V |
| | 4 | 26 | 26 | 26 | 26 | \$ 7,504 | \$ 7,571 | \$ 7,665 | \$ 7,816 | \$ 4,595 | \$ 4,921 | \$ 5,248 | \$ 5,574 | |
| | 6 | 40 | 39 | 39 | 38 | \$ 5,954 | \$ 6,029 | \$ 6,147 | \$ 6,346 | \$ 5,228 | \$ 5,554 | \$ 5,881 | \$ 6,207 | |
| | 7 | 52 | 51 | 51 | 49 | \$ 4,424 | \$ 4,581 | \$ 4,739 | \$ 4,968 | \$ 5,808 | \$ 6,134 | \$ 6,461 | \$ 6,788 | |
| | 9 | 65 | 64 | 63 | 62 | \$ 2,888 | \$ 3,052 | \$ 3,265 | \$ 3,490 | \$ 6,441 | \$ 6,767 | \$ 7,094 | \$ 7,421 | |
| | 11 | 77 | 76 | 74 | 72 | \$ 2,902 | \$ 2,958 | \$ 3,024 | \$ 3,125 | \$ 7,021 | \$ 7,348 | \$ 7,674 | \$ 8,001 | |
| | 13 | 90 | 88 | 85 | 84 | \$ 2,932 | \$ 2,984 | \$ 3,070 | \$ 3,139 | \$ 7,654 | \$ 7,980 | \$ 8,307 | \$ 8,634 | |
| | 15 | 102 | 100 | 97 | 95 | \$ 2,957 | \$ 3,021 | \$ 3,095 | \$ 3,160 | \$ 8,287 | \$ 8,613 | \$ 8,940 | \$ 9,267 | |
| | 17 | 113 | 110 | 108 | 106 | \$ 2,986 | \$ 3,051 | \$ 3,107 | \$ 3,193 | \$ 8,867 | \$ 9,194 | \$ 9,520 | \$ 9,847 | |
| | 19 | 124 | 122 | 119 | 117 | \$ 3,026 | \$ 3,076 | \$ 3,146 | \$ 3,202 | \$ 9,500 | \$ 9,827 | \$ 10,153 | \$ 10,480 | |
| | 21 | 136 | 133 | 131 | 128 | \$ 3,034 | \$ 3,091 | \$ 3,148 | \$ 3,205 | \$ 10,080 | \$ 10,407 | \$ 10,733 | \$ 11,060 | |
| | 23 | 148 | 145 | 142 | 140 | \$ 3,049 | \$ 3,104 | \$ 3,164 | \$ 3,227 | \$ 10,713 | \$ 11,040 | \$ 11,366 | \$ 11,693 | |
| | | All Electric Range (AER) in Km | | | | Operational Cost in \$ for 10 years | | | | Powertrain Cost in \$ w/o Battery Replacement | | | | |

| | | Motor Power (kW) | | | | |
|----------------------|----|---|------|------|------|------------------|
| | | 55 | 70 | 85 | 100 | |
| Battery Energy (kWh) | 2 | 4.11 | 4.15 | 4.20 | 4.24 | P H E V |
| | 4 | 4.12 | 4.15 | 4.18 | 4.24 | |
| | 6 | 4.13 | 4.18 | 4.20 | 4.26 | |
| | 7 | 4.15 | 4.18 | 4.22 | 4.29 | |
| | 9 | 4.15 | 4.20 | 4.25 | 4.29 | |
| | 11 | 4.17 | 4.22 | 4.26 | 4.31 | |
| | 13 | 4.21 | 4.24 | 4.29 | 4.34 | |
| | 15 | 4.23 | 4.26 | 4.31 | 4.36 | |
| | 17 | 4.25 | 4.27 | 4.32 | 4.37 | |
| | 19 | 4.25 | 4.30 | 4.35 | 4.39 | |
| | 21 | 4.29 | 4.31 | 4.36 | 4.41 | |
| | 23 | 4.28 | 4.33 | 4.39 | 4.43 | |
| | | Fuel Economy during CS mode in L/100 Km | | | | |

Table 20 HEV family data for various combination of powertrain components

| | | Motor Power (kW) | | | | Motor Power (kW) | | | | Motor Power (kW) | | | | |
|----------------------|---|--------------------------|------|------|------|-------------------------------------|----------|----------|----------|---|----------|----------|----------|-------------|
| | | 55 | 70 | 85 | 100 | 55 | 70 | 85 | 100 | 55 | 70 | 85 | 100 | |
| Battery Energy (kWh) | 2 | 4.03 | 4.08 | 4.13 | 4.17 | \$10,472 | \$10,612 | \$10,736 | \$10,853 | \$ 4,014 | \$ 4,341 | \$ 4,668 | \$ 4,994 | H E V |
| | 4 | 4.04 | 4.09 | 4.13 | 4.17 | \$10,515 | \$10,632 | \$10,730 | \$10,843 | \$ 4,595 | \$ 4,921 | \$ 5,248 | \$ 5,574 | |
| | 6 | 4.04 | 4.10 | 4.15 | 4.19 | \$10,514 | \$10,670 | \$10,778 | \$10,898 | \$ 5,228 | \$ 5,554 | \$ 5,881 | \$ 6,207 | |
| | 7 | 4.06 | 4.11 | 4.16 | 4.21 | \$10,568 | \$10,677 | \$10,811 | \$10,937 | \$ 5,808 | \$ 6,134 | \$ 6,461 | \$ 6,788 | |
| | | Fuel Economy in L/100 Km | | | | Operational Cost in \$ for 10 years | | | | Powertrain Cost in \$ w/o Battery Replacement | | | | |

⁸ All the costs mentioned in Table 18 is in Canadian dollar (\$CAD)