



Thesis for the degree of Doctor of Philosophy
Östersund 2012

**ROLLER SKIS' ROLLING RESISTANCE AND GRIP
CHARACTERISTICS
– INFLUENCES ON PHYSIOLOGICAL AND PERFORMANCE
MEASURES IN CROSS-COUNTRY SKIERS**

Mats Ainegren

Supervisors:

Professor Peter Carlsson, Mid Sweden University
Associate Professor Marko Laaksonen, Mid Sweden University

Department of Engineering and Sustainable Development
Mid Sweden University, SE-831 25 ÖSTERSUND, Sweden

ISSN 1652-893X
Mid Sweden University Doctoral Thesis 125
ISBN 978-91-87103-15-5

Akademisk avhandling som med tillstånd av Mittuniversitetet framläggs till offentlig granskning för avläggande av teknologie doktorsexamen med inriktning laborativ sportteknologi onsdagen den 23 maj 2012, klockan 13.00 i sal Q221, Mittuniversitetet, Östersund. Seminariet kommer att hållas på svenska.

Investing in your future



EUROPEAN UNION
European Regional
Development Fund

ROLLER SKIS' ROLLING RESISTANCE AND GRIP CHARACTERISTICS – INFLUENCES ON PHYSIOLOGICAL AND PERFORMANCE MEASURES IN CROSS-COUNTRY SKIERS

Mats Ainegren

© Mats Ainegren, 2012

Department of Engineering and Sustainable Development
Mid Sweden University, SE-831 25 Östersund
Sweden

Telephone: +46 (0)771-975 000

Printed by Kopieringen Mid Sweden University, Sundsvall, Sweden, 2012

**ROLLER SKIS' ROLLING RESISTANCE AND GRIP
CHARACTERISTICS – INFLUENCES ON PHYSIOLOGICAL AND
PERFORMANCE MEASURES IN CROSS-COUNTRY SKIERS**

Mats Ainegren

Department of Engineering and Sustainable Development
Mid Sweden University, SE-831 25 Östersund, Sweden
ISSN 1652-893X, Mid Sweden University Doctoral Thesis 125;
ISBN 978-91-87103-15-5

ABSTRACT

The aim of this thesis was to investigate roller ski characteristics; classical and freestyle roller skis' rolling resistance coefficients (μ_R) and classical style roller skis' static friction coefficients (μ_S), and to study the influence of different μ_R and μ_S on cross-country skiers' performance and both physiological and biomechanical indices. The aim was also to study differences in skiing economy and efficiency between recreational skiers, female and male junior and senior elite cross-country skiers.

The experiments showed that during a time period of 30 minutes of rolling on a treadmill (warm-up), μ_R decreased significantly ($p < 0.05$) to about 60-65 % and 70-75 % of its initial value for freestyle and classical roller skis respectively. Also, there was a significant influence of normal force on μ_R , while different velocities and inclinations of the treadmill only resulted in small changes in μ_R .

The study of the influence on physiological variables of a ~50 % change in μ_R showed that during submaximal steady rate exercise, external power, oxygen uptake, heart rate and blood lactate were significantly changed, while there were non-significant or only small changes to cycle rate, cycle length and ratings of perceived exertion. Incremental maximal tests showed that time to exhaustion was significantly changed and this occurred without a change in maximal power, maximal oxygen uptake, maximal heart rate and blood lactate, and that the influence on ratings of perceived exertion was non-significant or small.

The study of classical style roller skis μ_S showed values that were five to eight times more than the values of μ_S reported from on-snow skiing with grip-waxed cross-country skis.

The subsequent physiological and biomechanical experiments with different μ_S showed a significantly lower skiing economy (~14 % higher $\dot{V}O_2$), higher heart rate, lower propulsive forces coming from the legs and shorter time to exhaustion (~30 %) when using a different type of roller ski with a μ_S similar to on-snow skiing, while there was no difference between tests when using different pairs of roller skis with a (similar) higher μ_S .

The part of the thesis which focused on skiing economy and efficiency as a function of skill, age and gender, showed that the elite cross-country skiers had better skiing economy and higher gross efficiency (5-18 %) compared with the recreational skiers, and the senior elite had better economy and higher efficiency (4-5 %) than their junior counterparts, while no differences could be found between the genders.

Keywords: Adjustable grip, blood lactate, centre of pressure, cycle length, cycle rate, economy, efficiency, friction coefficient, heart rate, normal force, OBLA, oxygen uptake, power, ratcheted wheel, ratings of perceived exertion, roller skis, rolling resistance, tangential force, time to exhaustion

SAMMANFATTNING

Syftet med denna avhandling var att undersöka fristils- och klassiska rullskidors rullmotståndskoefficienter (μ_R) och klassiska rullskidors statiska friktionskoefficienter (μ_S) samt effekter av olika μ_R och μ_S på längdskidåkarens prestation vid rullskidåkning på rullande band. Syftet var även att undersöka s.k. åkeekonomi och mekanisk verkningsgrad mellan motionärer och kvinnliga och manliga junior- och seniorlängdskidåkare på elitnivå.

Experimenten visade att under en period av 30 minuters kontinuerligt rullande, på rullande band, så sjönk μ_R signifikant ($p < 0.05$) till 60-65 % och 70-75 % av initiala värden, för fristils- respektive klassiska rullskidor. Undersökandet av olika normalkrafter, hastigheter och lutningars påverkan på μ_R resulterade i en signifikant, negativ korrelation för μ_R som funktion av normalkraft, medan olika hastigheter och lutningar endast medförde små förändringar av μ_R .

Studien som undersökte fysiologiska effekter av olika μ_R visade, vid submaximala konstanta arbetsbelastningar, att yttre effekt, syreupptagning, hjärtfrekvens och blodlaktat förändrades signifikant vid ~50 % förändring av μ_R . Försökspersonernas frekvens och sträcka per frekvens samt skattning av upplevd ansträngning resulterade dock i mestadels icke signifikanta eller små förändringar. Protokollen med successivt ökande arbetsbelastning (maxtest) resulterade i signifikant förändrad tid till utmattning, vid ~50 % förändring av μ_R . Detta inträffade utan signifikant skillnad i maximal syreupptagning, hjärtfrekvens och blodlaktat, vilket även mestadels gällde för skattning av upplevd ansträngning.

Experimenten som undersökte klassiska rullskidors μ_S visade att dessa erhöll värden som är fem till åtta gånger högre än vad som rapporterats från studier av μ_S på snö med fästvallade skidor.

Den efterföljande studien som undersökte fysiologiska och biomekaniska influenser av olika μ_S visade, vid submaximala konstanta arbetsbelastningar, att åkeekonomin försämrades (~14 % högre syreförbrukning), hjärtfrekvensen ökade, den framåt drivande kraften från benen på rullskidorna minskade samt att det blev kortare tid till utmattning (~30 %), vid maxtest, när skidåkarna använde rullskidor med en μ_S i likhet med vad som rapporterats för skidåkning på snö. För arbetsförsöken med olika rullskidor av olika fabrikat med en högre, och likartad, μ_S förelåg ingen skillnad i de undersökta variablerna.

Studien som undersökte åkeekonomi och mekanisk verkningsgrad som funktion av prestationsnivå, ålder och kön, visade att elitskidåkarna hade bättre åkeekonomi och verkningsgrad (5-18 %) i jämförelse med motionärerna, att seniorerna hade bättre åkeekonomi och verkningsgrad (4-5 %) än juniorerna och att ingen skillnad kunde konstateras mellan könen.

LIST OF PAPERS

This doctoral thesis is based on the following five papers, herein referred to by their Roman numerals. The published articles are reprinted with permission from the publishers.

- Paper I Rolling resistance for treadmill roller skiing
Mats Ainegren, Peter Carlsson, Mats Tinnsten
Sports Eng (2008) 11:23-29
- Paper II Roller ski rolling resistance and its effects on elite athletes' performance
Mats Ainegren, Peter Carlsson, Mats Tinnsten
Sports Eng (2009) 11: 143-157
- Paper III Skiing Economy and Efficiency in Recreational and Elite Cross-Country Skiers
Mats Ainegren, Peter Carlsson, Mats Tinnsten, Marko Laaksonen
J Strength Cond Res (2012) Epub ahead of print
doi: 10.1519/JSC.0b013e31824f206c.
- Paper IV An experimental study to compare the grip of classical style roller skis with on-snow skiing
Mats Ainegren, Peter Carlsson, Mats Tinnsten
Sports Eng (under review)
- Paper V The influence of grip on skiing economy and leg forces when using classical style roller skis
Mats Ainegren, Peter Carlsson, Marko Laaksonen, Mats Tinnsten
Scand J Med Sci Sports (under review)

ABBREVIATIONS

Mechanics

α	Inclination of the treadmill [°]
CAM_{UNSTR}	Camber-Ski with unstrained camber
$CAM_{0.2\mu S}$	Camber-Ski with a μ_S of 0.2
CP_Z	Centre of pressure in the tangential direction [m]
$CP_{Z,ROM}$	Centre of pressure range of motion [m]
F	Vertical load on roller ski [N]
F_X	Tangential force [N]
F_Z, N	Normal force [N]
F_{tX}	Tangential force impulse [Ns]
F_{tZ}	Normal force impulse [Ns]
F_l	Resisting force of the load wheel [N]
F_f	Resisting force of the forward wheel [N]
F_r	Resisting force of the rear wheel [N]
g	acceleration of gravity [9.81 m · s ⁻²]
m	mass [kg]
P	Power from elevating the transported mass against gravity [W]
$P_{\mu R}$	Power from overcoming the roller skis rolling resistance [W]
$P_{W,EXT}$	External power, $P + P_{\mu R}$ [W]
$p_{W,EXT}$	External power per kg, $p + p_{\mu R}$ [W · kg ⁻¹]
$P_{W,MAX}$	Maximal, external power [W]
R_S	Ratcheted spool
$R_{W,REAR}$	Ratcheted rear wheel
$R_{W,FORW}$	Ratcheted forward wheel
S', S	Forces registered in the load cell [N]
T	Temperature [°C]
v	Velocity, speed of the treadmill [m · s ⁻¹] [km · h ⁻¹] [m · min ⁻¹]
μ_R	Rolling resistance coefficient
μ_S	Static friction coefficient

Physiology

B-Hla	Blood lactate concentration [mmol · L ⁻¹]
CR	Cycle rate [1 · min ⁻¹]
CL	Cycle length, [m · C ⁻¹]
HR	Heart rate [1 · min ⁻¹]
HR_{MAX}	Maximal heart rate [1 · min ⁻¹]
HR_{PEAK}	Peak heart rate [1 · min ⁻¹]
K_{CAL}	Calorie expenditure · 1000
E_{GROSS}	Gross energy expenditure [K _{CAL} · min ⁻¹]
OBLA	Onset of blood lactate accumulation [4 mmol · L ⁻¹]
$P_{W,INT}$	Internal power, $E_{GROSS}/0.01433$ [W]
$p_{W,INT}$	Internal power per kg [W · kg ⁻¹]
RPE_{BREATH}	Ratings of perceived exertion, breathing [scale 6-20]
RPE_{ARM}	Ratings of perceived exertion, arms [scale 6-20]
RPE_{LEG}	Ratings of perceived exertion, legs [scale 6-20]
RQ	Respiratory quotient [$\dot{V}CO_2/\dot{V}O_2$]
TTE	Time to exhaustion [min]
$\dot{V}CO_2$	Carbon dioxide production [L · min ⁻¹]
$\dot{V}O_2$	Oxygen uptake [L · min ⁻¹]
$\dot{v}O_2$	Oxygen uptake per kg [mL · kg ⁻¹ · min ⁻¹]
$\dot{V}O_{2,MAX}$	Maximal oxygen uptake [L · min ⁻¹]
$\dot{v}O_{2,MAX}$	Maximal oxygen uptake per kg [mL · kg ⁻¹ · min ⁻¹]
$\dot{V}O_{2,PEAK}$	Peak oxygen uptake [L · min ⁻¹]
$\dot{v}O_{2,PEAK}$	Peak oxygen uptake per kg [mL · kg ⁻¹ · min ⁻¹]

Skiing techniques

G3	Freestyle, gear 3
DP	Classical, double poling
DP _{KICK}	Classical, double poling with kick from one leg
DS	Classical, diagonal stride

Statistics

<i>CV</i>	Coefficient of variation
<i>p</i>	Significant coefficient
<i>r</i>	Correlation coefficient
<i>SD</i>	Standard deviation
<i>TEM</i>	Technical error of measurement

Subject identification

M _{REC}	Male recreational skiers
M _{SEN}	Male senior elite biathletes and cross- country skiers
M _{JUN}	Male junior elite biathletes and cross- country skiers
F _{SEN}	Female senior elite biathletes and cross-country skiers
F _{JUN}	Female junior elite biathletes and cross-country skiers

PREFACE

My interest in roller skis' rolling resistance began in the early 2000s, when I started to work with the physiological testing of elite athletes who were roller skiing on a ski-treadmill. At that time there was no product on the market that was designed to check the roller skis' rolling resistances.

During testing I frequently asked myself;

“How big is the day to day variation in rolling resistance of the roller skis that we are using during testing and what happens to the rolling resistance after weeks and months of use? Are there significant differences in rolling resistance between different pairs of the same type of roller skis from the same manufacturer? What about the rolling resistance of a new pair of roller skis that is brought in for use during testing, when the pair we are using now is worn out?”

And, the central issue:

“What about the physiological effects of any changes in the roller skis' rolling resistance?”

Based upon the measurements of oxygen consumption, comparisons were sometimes made between different tests with the aim of investigating skiing economy. “Is it valid to do what we are doing, i.e. comparing skiing economy between test occasions and subjects without knowing whether the roller skis' rolling resistance is similar and whether the rolling resistance is influenced by skiers with different body masses?”

Some journal papers described how researchers connected a subject to a sensor with a line when rolling on a treadmill, but this method did not seem to have the desired level of accuracy since it showed diverging results for the influence on rolling resistance of mass, velocity and incline.

All the questions above also came from the following overall speculations:

“Is it such a good idea to carry out physiological experiments on a treadmill without knowing the reproducibility of the roller skis' rolling resistance and thereby the accuracy of the method? Is this method used in research on cross-country skiers, biathletes and ski-orientees to be regarded as a scientific method if not all equipment can be calibrated and/or controlled?”

In 2003, I received an offer to move to Östersund and start employment at the Swedish Winter Sports Research Centre (SWSRC), which was then a project initiated by the regional sports association with financial support from the European Union. The offer came from the project manager, Bertil Karlsson, and the assistant project manager, and project manager of the Mid Sweden Ski-University, Anders Edholm. This was at a time when the project was new and my only colleague at the time at the laboratory, future Ph.D. Glenn Björklund, and myself were continuously building the laboratory in parallel with the testing of Swedish elite athletes in winter sports. We were fortunate to have greatest support from

the world famous physiologist, Professor Bengt Saltin, Copenhagen Muscle Research Centre, also a Guest Professor at Mid Sweden University. Bengt has been of great help for me, especially as a sounding board regarding the design of the second and third studies in this thesis. It was also Bengt who suggested that I start using a method for venous blood sampling.

One day, when having lunch at a restaurant, I came in contact with Professor Mats Tinnsten from the Dep. of Engineering and Sustainable Development (then Ass. Prof. at Dep. of Engineering, Physics and Mathematics). Mats Tinnsten was very interested in the laboratory and became especially interested when I described the problem of not being able to control the reproducibility of the roller skis' rolling resistance. Another person who soon joined our small group and who was interested in roller skis' rolling resistance, and the reproducibility of the physiological measurements, was Mats' colleague, and my upcoming main supervisor, Professor Peter Carlsson. Without the support of Mats, Peter and Bengt, the studies within this thesis would probably never have started.

The first half of the thesis investigates several of the questions raised above, which were already present when I began my doctoral studies. The ideas for the other half came to me later on, 1½ years in to my doctoral studies, when fly-fishing. “Piscator non solum piscatur”, i.e. “There is more to fishing than catching fish” (Izaak Walton, *The Compleat Angler*, 1653).

I started thinking about the compromise that exists during classical style cross-country skiing; this is between putting the necessary grip wax on to the skis to retrieve sufficient friction, so as to be able to apply propulsive force from the legs on the skis and the snow in the uphill, but not to put on more than necessary because the negative affect this has on the skis during their gliding on the snow. The more grip wax that is applied the worse the glide gets. It is well known among skiers, ski-waxers and coaches that individual skiers are more or less dependent on the grip due to differences in their technical skiing skill. Some skiers simply need to give priority to more grip wax than others.

My idea was to carry out a study where the grip and glide of the roller skis was varied reciprocally between different performance tests, using a simulated ski track on a treadmill. The questions that were supposed to be answered were: How much grip do the skiers need for an optimal performance? What is the optimal compromise between the skis' grip and glide abilities?

During a conference trip to Hawaii I told Peter and Mats about this idea and Mats said: “But then we need a new type of roller ski with adjustable grip and glide functions”. During the evenings at the hotel at Waikiki Beach, Honolulu, the three of us sat on a balcony and started discussions about the construction of a new type of roller ski. Several prototypes were later manufactured and rejected before we came up with the solution using the roller ski mechanics I have used in the experiments in this thesis. Even though an exact study

design as described above was not carried out within the room of this thesis, the studies IV and V contain other questions which were necessary to investigate as a starting point for future research.

The experiments in the studies have been mostly carried out by me in the lab at SWSRC. Handling all the equipment alone during the experiments can be very hectic, but the practical handling of all the different equipment is, in my opinion, a clear advantage in really learning about the errors that exist due to the handling of and the equipment itself, as well as the advantages and disadvantages of different equipment and methods.

It is my belief that this thesis has increased the knowledge of roller skis' behaviour and the effects that roller skis have on the physiology and biomechanics of cross-country skiers. My hope is thus that this knowledge will be used by researchers in the future to increase the accuracy and relevance of experiments carried out during treadmill roller skiing. However, there are still more things that need development to make this research method even more similar to on-snow skiing.

TABLE OF CONTENTS

ABSTRACT	V
SAMMANFATTNING	VII
LIST OF PAPERS	IX
ABBREVIATIONS	XI
PREFACE	XIII
1 INTRODUCTION	1
1.1 ON-SNOW SKIING VERSUS ROLLER SKIING	1
1.2 ROLLER SKIS' ROLLING RESISTANCE.....	1
1.3 CLASSICAL STYLE ROLLER SKIS' GRIP	2
1.4 MAXIMAL OXYGEN UPTAKE AND SKIING ECONOMY	4
1.5 PURPOSE	6
2 METHODS	7
2.1 EQUIPMENT.....	7
2.1.1 <i>Roller skis</i>	7
2.1.2 <i>Rolling resistance measurement system</i>	8
2.1.3 <i>Grip measurement system</i>	10
2.1.4 <i>Force measurement system</i>	12
2.1.5 <i>Ergo-spirometry system</i>	13
2.2 STUDY DESIGNS	14
2.2.1 <i>Pilot studies</i>	15
2.2.2 <i>Assessment of physiological data</i>	17
2.2.3 <i>Study I</i>	18
2.2.4 <i>Study II</i>	19
2.2.5 <i>Study III</i>	20
2.2.6 <i>Study IV</i>	22
2.2.7 <i>Study V</i>	23
2.3 STATISTICAL ANALYSES.....	24
3 RESULTS AND DISCUSSION	27
3.1 STUDY I. ROLLER SKIS' ROLLING RESISTANCE COEFFICIENTS	27
3.1.1 <i>Warm-up study</i>	27
3.1.2 <i>The influence on μ_R of normal force, velocity and inclination</i>	28

3.2	STUDY II. PHYSIOLOGICAL RESPONSES TO DIFFERENT ROLLING RESISTANCE	
	COEFFICIENTS	31
3.2.1	<i>Rolling resistance coefficients</i>	31
3.2.2	<i>The influence of μ_R on steady state exercises</i>	31
3.2.3	<i>The influence of μ_R on incremental maximal tests</i>	36
3.3	STUDY III. ECONOMY AND EFFICIENCY IN RECREATIONAL AND ELITE SKIERS	37
3.4	STUDY IV. CLASSICAL STYLE ROLLER SKIS' GRIP	40
3.5	STUDY V. THE INFLUENCE OF GRIP ON ECONOMY AND LEG FORCES	42
3.5.1	<i>The influence of μ_S on physiological measures</i>	42
3.5.2	<i>The influence of μ_S on leg forces</i>	44
3.6	METHODOLOGICAL CONSIDERATIONS.....	47
3.7	CONCLUSIONS.....	48
4	ACKNOWLEDGEMENTS.....	51
5	REFERENCES.....	53

1 INTRODUCTION

1.1 On-snow skiing versus roller skiing

With the aim of imitating skiing on snow, cross-country skiers, biathletes and ski-orientees use roller skis for their snow-free training. Furthermore, over the last few decades, fairly specific testing methods for cross-country skiers, biathletes and ski-orientees have become possible due to the development of treadmills that allow roller skiing using classical and freestyle techniques.

Outdoor experiments on snow, using cross-country skiers, biathletes and ski-orientees, are difficult to standardize due to changes in factors that influence the grip and glide of the skis and the skier, and thus the energy expenditure. Such factors are air and snow temperature, humidity and snow and wind conditions. Also, cross-country skis are constructed in different lengths, and the skis' camber (in contrast to roller skis) has different heights and stiffness to enable skiers to choose ski characteristics to suit their relative body length, mass and technical skiing skill. Thus, using the same pair of skis for all subjects means badly matched skis for the individual, while individually matched skis can be difficult to standardize as regards grip and glide. Moreover, it is difficult to control the intended speed and to find a track profile with proper, relatively constant, inclination for the specific core-technique during the time required to retrieve stable energy expenditure.

Therefore, much of the current sports research into the physiology and biomechanics of cross-country skiing is conducted indoors on treadmills and using roller skis, due to the possibility of using a wide range of advanced equipment for different types of analyses and for benefitting from comparisons that use relatively stationary and reproducible conditions.

However, methodological errors will always exist in experiments and results should therefore be related to the errors of the variables examined in the experiments. Furthermore, the differences in performance predicting factors among elite athletes are quite small, thus emphasising the importance of standardising the roller skis used in the experiments on cross-country skiers, biathletes and ski-orientees. Thus, in parallel with physiological and biomechanical research, reproducibility studies and the development of equipment and testing methods are important in order to minimize errors and to increase the specificity, validity and reliability of the specific testing method and thereby the relevance of the research conducted using the athletes.

Even though roller skiing on a treadmill never will be 100 % similar to skiing on snow, it can be more or less similar depending on the equipment used by the skier and the skiing conditions, i.e. the similarity between cross-country skis and snow versus roller skis and treadmill conditions.

1.2 Roller skis' rolling resistance

Using roller skis results in a need to control their rolling resistance coefficients (μ_R), which is of great importance in securing good reproducibility for this specific method in order to

make accurate comparisons and conclusions regarding the results of the treadmill experiments.

Only a few authors have studied the μ_R of roller skis. The method described in earlier studies was based on force measurements that were carried out using a skier wearing a backpack filled with varying mass. The skier was instructed to distribute the mass evenly on both roller skis whilst rolling on the treadmill (Hoffman *et al.* 1990a). However, the data presented when using this method showed varying results and no reliability testing for the method was presented (Hoffman *et al.* 1990a; Hoffman *et al.* 1995; Millet *et al.* 1998). A similar method, which investigated roller blades' rolling resistance on an outdoor surface, showed a variability of 20 % (de Boer *et al.* 1987).

Hoffman *et al.* (1990a) observed that the coefficient of roller skis' rolling resistance was not dependent on velocity but that it increased with increasing body mass. However, in 1994 and 1995 Hoffman *et al.* found that body mass did not affect μ_R , but that μ_R was related to speed. Millet *et al.* (1998), on the other hand, found that μ_R was not dependent on velocity for low-resistance roller skis but that it was dependent on velocity for high-resistance roller skis. If roller skis' μ_R is found to be influenced by different masses, one should also take into consideration any differences in external power ($P_{W\ EXT}$) in overcoming the roller skis' rolling resistance (P_{μ_R}), if differences exist in the skiers' body masses. This is not always investigated, and in Rundell & Szmedra (1998), the results were determined on the basis of the men's use of one type of roller ski of unknown μ_R , and the women's use of another type, also of unknown μ_R . The two types of roller skis came from different manufacturers. In Hoffman & Clifford (1990) the subjects used four different models of roller skis of unknown μ_R .

In 1990a, Hoffman *et al.* wrote that they allowed the roller skis to become warm prior to making force measurements, but they do not describe the amount of time that was needed nor any temperature registrations, and neither do they describe how great the differences in μ_R were between the cooler and the warmer roller ski. If rolling resistance is temperature dependent, this could be of great importance when comparing physiological results, since the roller skis might have different initial temperatures depending on different previous usages.

There are few studies which have investigated the biomechanical and physiological responses to different μ_R . However, the μ_R measurements were made on a ski treadmill, while the biomechanical and physiological measurements were made outdoors, in other environments and on other surfaces, i.e. on an asphalt oval (Millet *et al.* 1998) and on an asphalt roadway (Hoffman *et al.* 1998).

1.3 Classical style roller skis' grip

Cross-country skis that are intended for use in competitions and for training in the classical style have a surface against the snow that can be divided into three zones (Ekstrom 1981). The middle zone is waxed with grip wax (grip zone), while the front and rear zones are

waxed with glide wax (glide zones). The grip zone's task is to achieve sufficient friction between the ski and the snow to enable propulsive force that comes from the kick force from the legs, in the diagonal stride (DS), herringbone and kick double poling (DP_{KICK}) techniques, during the time when the ski surface is stationary on the snow (static friction).

In order for the grip zone to have a minimum effect on glide, cross-country skis have a concave camber of a certain height and stiffness, so that as much as possible of the grip zone is not in contact with the snow when the ski glides against it in the gliding phase (dynamic friction) (Ekstrom 1981). The amount of kick zone that does not have snow contact in the gliding phase mainly depends on how stiff and high the ski's camber is, according to the skier's body mass and the amount of grip wax that is applied. Cross-country skis' camber is thus constructed with different heights and stiffnesses, to enable skiers to choose them according to their body mass and technical skiing skill.

Classical style cross-country skis' static friction coefficients (μ_s), defined as the ratio between the tangential and normal forces acting on the ski when it is stationary on the snow, just before it starts gliding, have been studied using a force plate system attached to the skis (Ekstrom 1981; Komi 1987) and by using a long force platform system mounted under the snow (Komi 1985; Komi & Norman 1987; Vahasoyrinki *et al.* 2008). The advantages and disadvantages of the two methods are discussed by Komi (Komi 1987) and by Smith (Smith 2000). As a result, μ_s of 0.1 to 0.2 have been reported, estimated from tangential and normal forces of 0.1 to 0.2 and 1 to 3 times bodyweight, respectively (Ekstrom 1981; Komi 1985; Komi & Norman 1987; Vahasoyrinki *et al.* 2008).

The roller skis on the market that are intended for use in the classical style have a design where one of the two wheels (one wheel at the front and one at the back) has a ratchet that allows a grip on the surface (static friction) during a leg kick (for example; PRO-SKI C2, Sterners, Dala-Järna, Sweden; Swenor Fibreglass, Sarpsborg, Norway; Marwe Classic, Hyvinkään Kumi Oy, Finland). Since this ratcheted mechanism is not dependent on a load applied to the roller ski, in practice it is likely that this type of construction provides a high μ_s between the ratcheted wheel and the surface, independently of the skier's body mass and technical skiing skill. This is in great contrast to on-snow skiing on groomed trails, where a proper technique is essential for good grip.

However, even though ratcheted wheel roller skis provide the opportunity to apply a relatively higher tangential force in comparison to grip-waxed cross-country skis, and thereby a higher propulsive force, it is not certain that technically skilled and aware cross-country skiers are (mis)using this opportunity due to an awareness of the problem it may cause with their on-snow skiing technique. Therefore, the size of any difference in μ_s between ratcheted wheel roller skis and grip-waxed cross-country skis, and in this case, how it affects the physiology and biomechanics of cross-country skiers is unknown.

1.4 Maximal oxygen uptake and skiing economy

The probably most frequently measured, and important, factor in endurance sports is maximal oxygen uptake ($\dot{V}O_{2\text{ MAX}}$, $L \cdot \text{min}^{-1}$), due to its high correlation to performance for endurance athletes, and cross-country skiers in particular, especially when expressed in relation to body weight ($\dot{v}O_{2\text{ MAX}}$, $\text{ml} \cdot \text{kg}^{-1} \cdot \text{min}^{-1}$), (Bergh 1987; Bergh & Forsberg 2000; Ingjer 1991; Saltin 1997; Saltin & Astrand 1967). Other commonly investigated variables within endurance sports are power output, heart rate, blood lactate concentration, ratings of perceived exertion and stride frequency and stride length (McArdle *et al.* 2001).

Although an extremely high $\dot{V}O_{2\text{ MAX}}$ is essential for peak performance for cross-country skiers, it cannot be fully utilized during endurance competitions, with the exception of very short periods of time and over shorter distances, due to muscle fatigue and glycogen depletion (Allen *et al.* 2008; McArdle *et al.* 2001). Thus, the ability to utilize a high fraction of $\dot{V}O_{2\text{ MAX}}$ becomes very important; results from laboratory tests have been compared with field tests in environments similar to competitions for the purpose of such comparisons (Larsson & Henriksson-Larsen 2005; Mygind *et al.* 1994; Niinimaa *et al.* 1978; Niinimaa *et al.* 1979; Welde *et al.* 2003).

The utilization fraction is affected by the subject's ability to perform an efficient, economical skiing technique, often examined as defined by Cavanaugh and Kram (Cavanaugh & Kram 1985) using the term economy: the submaximal oxygen uptake per unit body weight ($\dot{v}O_2$, $\text{mL} \cdot \text{kg} \cdot \text{min}^{-1}$) required to perform a given task.

The economy of cross-country skiing has been studied outdoors from different perspectives during skiing on snow (Hoffman & Clifford 1990; Macdougall *et al.* 1979) and on bituminous concrete (Hoffman *et al.* 1990b) and asphalt surfaces by using roller skis (Hoffman *et al.* 1990a; Hoffman *et al.* 1998). It has also been studied during treadmill roller skiing using some different core techniques (Hoffman *et al.* 1994; Hoffman *et al.* 1995; Kvamme *et al.* 2005) and on biathletes, with or without rifles (Rundell & Szmedra 1998).

Other studies have used calculations of the external/internal power ratio, by calculating the external power from the weight of the skier, the friction of the skis and the air resistance (outdoors) and by converting the oxygen uptake into thermal equivalents, for the detection of human mechanical efficiency for a certain core technique (Hoffman *et al.* 1995; Niinimaa *et al.* 1978; Sandbakk *et al.* 2010; Sandbakk *et al.* 2011). Some differences appear in the efficiency calculations whether they are based upon the gross or net energy expenditure, where the gross energy expenditure is the sum of the resting metabolic rate (E_{RMR}) and the requirement of the exercise (E_{NET}) above E_{RMR} (McArdle *et al.* 2001). An additional efficiency calculation exists, delta efficiency, defined by Cavanaugh and Kram (1985) as the average gradient of the energy expended vs. work done curve between two specified limits for the work done.

Niinimaa *et al.* (1978) thus studied the net efficiency of intercollegiate cross-country skiers, which was found to be approximately 21 percent. Hoffman *et al.* (1995) studied delta efficiency between the genders during treadmill roller skiing, where women were

found to have greater efficiency than men in double poling (DP), while no difference was found for DS. Sandbakk and co-workers (2010, 2011) tested economy, aerobic energy expenditure (aerobic metabolic rate) and gross efficiency between Norwegian top class national and international sprint cross-country skiers during treadmill roller skiing using the free technique gear 3 (G3), where the international skiers were found to have higher gross efficiency than the national level skiers, while no difference was observed for economy and aerobic energy expenditure. In addition, Sandbakk *et al.* (2010, 2011) compared the total metabolic rate as a function of both the aerobic and the anaerobic metabolism. The latter was based on a certain value for blood lactate (B-Hla) as described by di Prampero and Ferretti (di Prampero & Ferretti 1999), where the international skiers were found to have lower anaerobic and total metabolic rates than the national skiers.

International and national top class competitors of both genders take part, along with a large number of recreational skiers, in competitions that are part of the FIS Marathon Cup, such as Vasaloppet, Birkebeinerrennet, Marcialonga, Finlandia Ski Marathon etc., and in national “hobby races”. Thus, the range in finishing time between the competitors in such races is very large (~4 to 12 hours in Vasaloppet).

Although several studies have investigated the economy and efficiency of cross-country skiers, there is a lack of data comparing economy and efficiency between different levels of cross-country skiers during treadmill roller skiing. Such a study would investigate whether, besides $\dot{V}O_2$ MAX, skiing economy and efficiency are determining factors in the great differences in performance times between the categories. Furthermore, measurements on juniors of both genders that are aiming for an elite career, and on elite seniors, could provide additional information about the development of economy and efficiency from teenage years to adulthood, as well as between the genders.

Interestingly, the $\dot{V}O_2$ is used in a broad spectrum of research, besides the evaluation of athletes’ aerobic capacity. Other areas of interest are health issues in which the level of aerobic exercise and capacity plays a big role in avoiding cardio-vascular disorder, high blood pressure, type 2 diabetes and some types of cancer (Aspenes *et al.* 2011; O’Donovan *et al.* 2010; Pate *et al.* 1995). Also, as long as the experiments involve much of the study subjects’ skeletal muscles in the task, measures of $\dot{V}O_2$ can be carried out to evaluate the use of different equipment (Glaner & Silva 2011; Holmberg & Nilsson 2008).

In summary, any influence of roller skis μ_R and μ_S on cross-country skiers’ physiology can advantageously be evaluated with measures of submaximal and maximal oxygen uptake (Hoffman *et al.* 1998; Hoffman *et al.* 1992; Millet *et al.* 1998). Additionally, equipment such as electromyography, 3-D motion analyses and force measurement systems can be used to find explanatory causes for any differences found in the metabolic variables.

1.5 Purpose

In study I (Paper I) the aim was to evaluate roller skis' μ_R using specific equipment for rolling resistance measurements. The purpose was to clarify how the μ_R is related to mass, velocity and incline. Moreover, the warm-up study investigated whether and, if so, how long it takes until roller skis reach stationary conditions (equilibrium), i.e. is stable as regards μ_R and temperature. Furthermore, a reproducibility study was needed in order to indicate the validity and reliability of the results.

The aim of study II (Paper II) was to examine the physiological responses to different μ_R , i.e. whether a significantly different μ_R causes significant changes to $\dot{V}O_2$, heart rate, blood lactate, external power, ratings of perceived exertion, cycle rate and cycle length during submaximal exercise. Time to exhaustion and maximal power on incremental maximal tests also needed to be addressed. In addition, the dependence of $\dot{V}O_{2\text{ MAX}}$ on μ_R had to be addressed.

In study III (Paper III) the aim was to investigate skiing economy and gross efficiency during roller skiing from the perspectives of performance ability (elite vs. recreational) age (junior vs. senior) and gender. The hypothesis was that the senior elite athletes ought to have achieved the best economy and gross efficiency, due to the number of extra years of specific training compared to the juniors, and that the recreational skiers should have the least efficient technique.

The purpose of study IV (Paper IV) was to investigate the μ_S of ratcheted wheel roller skis and compare the results to μ_S reported from skiing on snow, i.e. with grip-waxed cross-country skis. Additionally, a different roller ski construction with a camber and adjustable grip function was evaluated.

Finally, in study V (Paper V) the aim was to examine the influence of classical style roller skis different μ_S on cross-country skiers' performance and both physiological and biomechanical indices. Besides measuring similar variables, as in study II, this study also investigated forces coming from the legs during the push-off phases when the roller ski is stationary on the surface.

2 METHODS

2.1 Equipment

All experiments, except in study IV, were carried out on a motorized treadmill (RL 3500, 3 × 2.5 m, Rodby Innovation AB, Vänge, Sweden). The inclination and velocity were checked during the experiments using a digital spirit level and a tachometer. The subjects used their own ski poles with a special tip for the treadmill's rubber surface (Jakobsen V, Oslo). The laboratory (8 × 5 × 4 m) was well ventilated and a cooling system held the temperature at fairly constant temperature (~19 °C) during the experiments.

2.1.1 Roller skis

The experiments used classical and freestyle roller skis from the open market, equipped with a forward and a rear wheel and with conventional roller bearings in the hub (PRO-SKI classic C2 and C3, Ø67 mm, width 50 mm; PRO-SKI freestyle S1 and S2, Ø70 mm, width 30 mm, Sterners, Dala-Järna, Sweden; Swenor classic Fibreglass, Ø68 mm, width 45mm, Sarpsborg, Norway; Marwe classic, Ø80 mm, width 39 mm, Hyvinkään Kumi Oy, Finland), see Fig. 1.



Fig. 1 Representative classical and freestyle roller skis and wheels used in the studies (PRO-SKI C2 and S2).

For the classical roller skis, one of the wheels had a ratchet to enable grip on the surface (PRO-SKI, ratcheted rear wheel; Swenor, ratcheted rear wheel; Marwe, ratcheted forward wheel). For the PRO-SKI C2 and S2 roller skis the material of the wheels were known; medium hard rubber wheels and thermoplastic polyurethane 80 degree shore A wheels, respectively. All roller skis had been used on the treadmill before the experiments, with different rolling ages that varied from ten hours up to several hundred hours.

Furthermore, a new type of roller ski with a camber and adjustable grip function was used (Camber-Ski, Mid Sweden University, Östersund, Sweden), see Fig. 2. The functionality for this was applied to the forward wheel of the roller ski. When sufficient load to press down the camber was exerted, the forward wheel established contact with a ratcheted spool (R_s , Ø 20 mm, stainless steel, cross knurling pattern size 1.6) situated above

the forward wheel. The degree of grip was therefore dependent on the stiffness of the roller ski's camber, which was simply adjusted via a spring-loaded screw (SF-TFX 2691, Lesjöfors Stockholms Fjäder AB). The Camber-Skis were supplied with wheels of the same type as the non-ratcheted wheel of PRO-SKI C2.

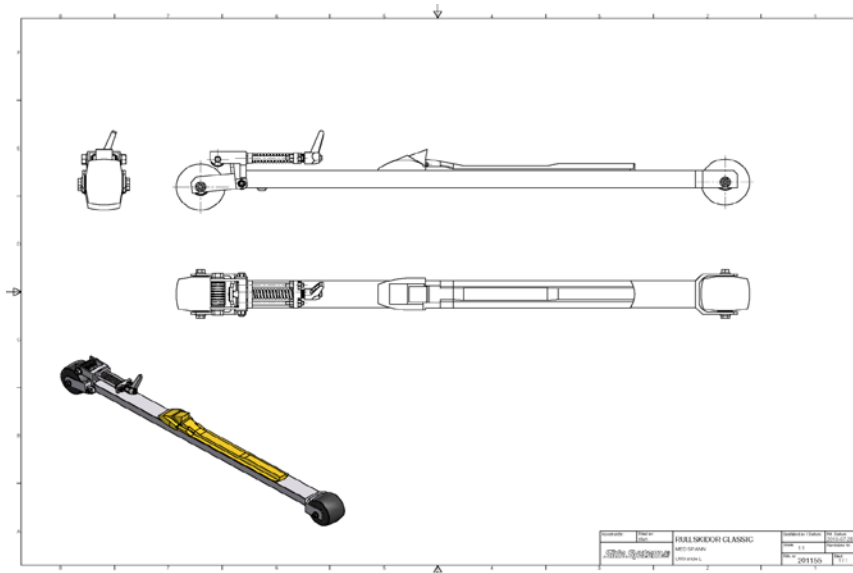

Fig. 2 The Camber-Ski, with the camber and adjustable grip function.

The roller skis were equipped with ski bindings (Salomon equipe or Rottefella R3) mounted with the ski boot fix point (located in front of the toes) at the roller skis centre of mass (classical roller skis) or 50 mm in front of the centre of mass (freestyle roller skis). The lengths between the axes of the forward and rear wheel and the mass of the roller ski with the ski binding were: PRO-SKI C2 and C3, 722 mm, 1.1 kg; S1 and S2, 613 mm, 1.0 kg; Swenor, 717 mm, 1.2 kg; Marwe, 703 mm, 1.2 kg; Camber-Ski, 722 mm, 1.4 kg.

The PRO-SKI C2 was used in all five studies, the S2 in study I, II and III, the C3 and S1 in study II, Swenor classic and Marwe classic in study IV and the Camber-Ski in studies IV and V.

2.1.2 Rolling resistance measurement system

The classical and freestyle roller skis' rolling resistance was measured on the treadmill surface with the roller skis mounted in a fixture specially produced for these types of measurements (RRMS, Side System AB, Oviken, Sweden), see Fig. 3. Samples were taken with an S2 force transducer (Hottinger Baldwin Messtechnik GmbH, Darmstadt, Germany) at a rate of 1 Hz. The temperature measurements carried out in study I, on the roller skis close to the rear wheel bolt, were done with a digital thermometer and sensor (GMH 3250,

thermocouple type K with a rate of 0.33 Hz) from Greisinger electronic GmbH, Regenstauf, Germany.

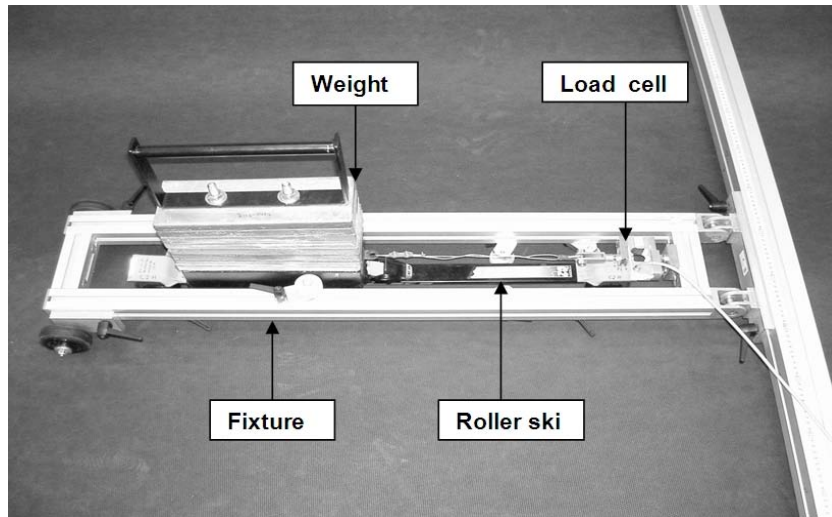

Fig 3 Roller ski with load of lead plates and the RRMS equipment for rolling resistance measurements.

In study V, a rolling resistance regulating function (0.1 kg) was applied to one of the wheels in order to standardize a μ_R of 0.03 between the tested roller skis, see Fig 4. Two roller bearings, whose pressure on the rubber wheel was regulated using a spring-loaded screw, regulated the rolling resistance of the individual roller ski.

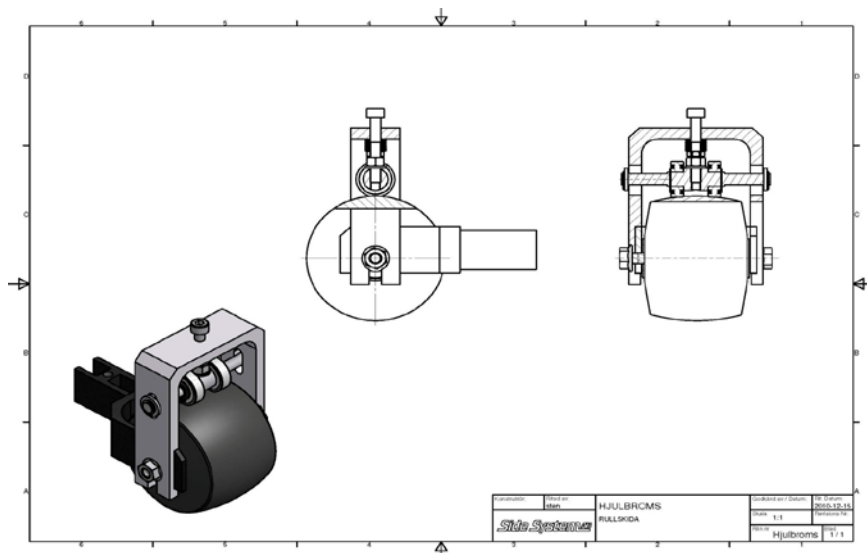

Fig. 4 The rolling resistance regulating function applied to one of the wheels.

There is a schematic sketch of the rolling resistance experimental setup in the free-body diagram in Fig. 5.

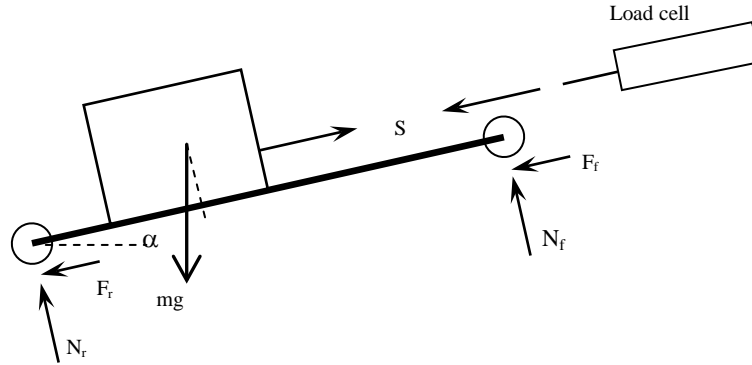

Fig. 5 Free-body diagram of the experimental setup. Angle α is the inclination of the treadmill, S is the force registered in the load cell, m is the total mass of the roller ski and the load, g is the acceleration of gravity, N is normal force, F is rolling resistance and index r and f indicate the rear and forward positions of the forces.

Roller ski equilibrium in the direction of the incline, and perpendicular to it, produces the equations

$$F_r + F_f = S - mg \sin \alpha \quad (1)$$

and

$$N_r + N_f = N_{TOTAL} = mg \cos \alpha \quad (2)$$

With the coefficient of rolling resistance, μ_R , defined as the ratio of the total resisting force to the total normal force, the following relationship can be established

$$\mu_R(N_{TOTAL}, \alpha) = \frac{F_r + F_f}{N_r + N_f} = \frac{S - mg \sin \alpha}{mg \cos \alpha} \quad (3)$$

This relationship was used in all calculations of μ_R in the studies.

2.1.3 Grip measurement system

The classical style roller skis' μ_S was measured with the roller skis mounted in a fixture with a function for applying different loads normal to the surface (F) and generating tangential traction on the roller ski (S), see Fig. 6 and 7.

The fixture was equipped with: 1) a bottom plate with an overlying rubber mat (unused) of the same type as used on the treadmill or; 2) a bottom plate with an asphalt surface, built and stored at room temperature for two months before the measurements were executed. Also, its surface was mechanically machined with a grinding tool to remove the smallest, most aggressive, parts of the surface.

The force F was measured with a C9B force transducer (Hottinger Baldwin Messtechnik GmbH, Darmstadt, Germany) and adjusted to the desired value using a screwed bar. The traction S' was executed with a lever device with a lever ratio of 10 and sampled with a K25 force transducer (Lorenz Messtechnik GmbH, Alfdorf, Germany) at a rate of 100 Hz.

To minimize the influence of resisting force from the vertical load (F_1), the bar was equipped with a stainless steel ball-bearing wheel which was able to roll on a flat aluminium sole mounted in the ski binding. The sole was vertically adjustable at the rear part, as well as the tangential traction point, to allow for level adjustments due to different loads and the constructions of the tested roller skis (h).

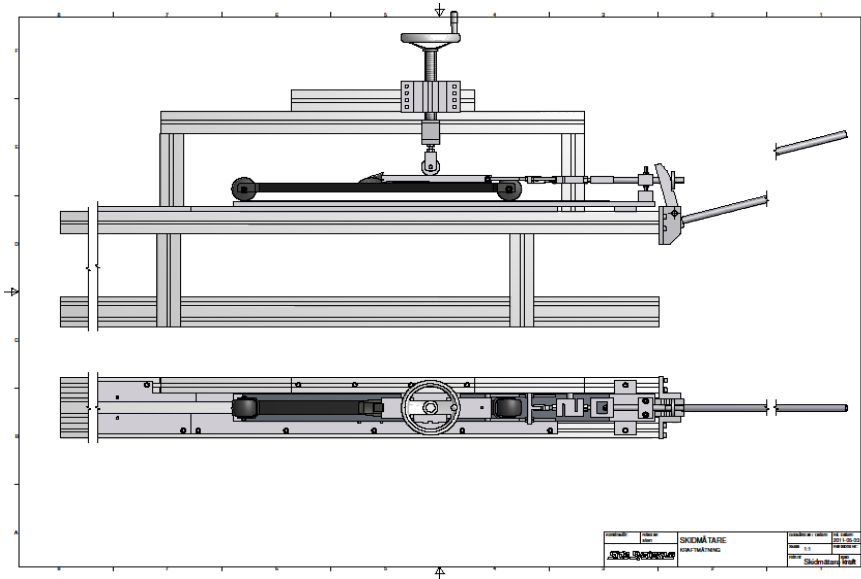

Fig. 6 The fixture in which the grip measurements were executed.

The tangential traction forces derived from the sum of the resisting forces (S) of the vertical stainless steel ball-bearing wheel and the forward and rear wheel of the roller skis were measured and finally subtracted from the results for μ_s , see equations (4-6). For the ratcheted wheel roller skis, measurements of S were executed by turning the ratcheted wheel to grip and roll, respectively, the opposite way, and for the Camber-Ski without any contact between the R_s and the forward wheel.

There is a schematic sketch of the grip measurements' experimental setup in the free-body diagram in Fig 7.

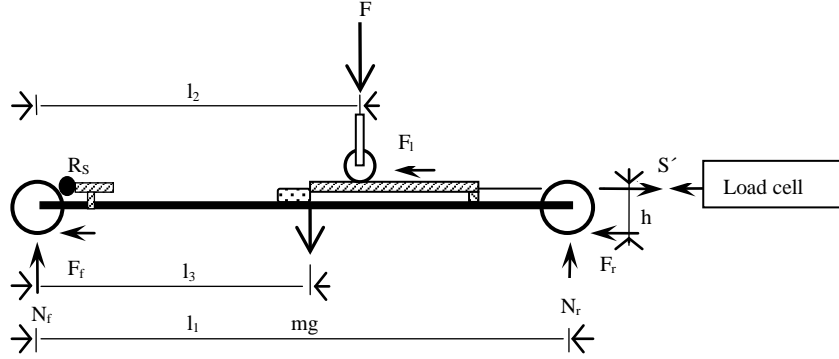

Fig. 7 Free body diagram of the experimental setup.

Horizontal equilibrium for the Camber-Ski, when measured without any contact between the R_s and the forward wheel, shows that:

$$S - F_f - F_r - F_i = 0 \quad (4)$$

In the situation when the R_s comes into contact with the forward wheel, the force registered in the load cell gives the equation:

$$S' - F_f' - F_r - F_i = 0 \quad (5)$$

With the static friction coefficient (μ_s) defined as the ratio of the resisting force to the normal force (N) on the wheel with the grip function (N_f or N_r), the following relationship was established:

$$\mu_s = \frac{S' - S}{N} \quad (6)$$

The individual normal forces of the forward (N_f) and rear (N_r) wheel were calculated as:

$$N_f = \frac{mg(l_1 - l_3) + F(l_1 - l_2) - S' \cdot h}{l_1} \quad (7)$$

and

$$N_r = \frac{mg \cdot l_3 + F \cdot l_2 + S' \cdot h}{l_1} \quad (8)$$

2.1.4 Force measurement system

In study V, the roller skis were supplemented with a force plate measurement system (1.2 kg) located between the ski binding and the roller ski, see Fig. 8. The system measured forces in three directions, using strain gauges (N2K-13-S015T-350, N2K-MC-S085N-350, Rio Nedo Temecula, USA) at the two areas of contact points, in front of (F_{FORW}) and

behind (F_{REAR}) the ski binding, at a horizontal distance of 0.484 m; two wireless voltage nodes and some software recorded the forces (1.33 KHz, V-Link, Node Commander, MicroStrain, Williston, USA). Two of the coordinates were summarized and analyzed; the tangential and normal forces ($F_X = F_{X \text{ FORW}} + F_{X \text{ REAR}}$, $F_Z = F_{Z \text{ FORW}} + F_{Z \text{ REAR}}$, N, parallel and perpendicular to the surface, respectively) during the leg push-off phases.

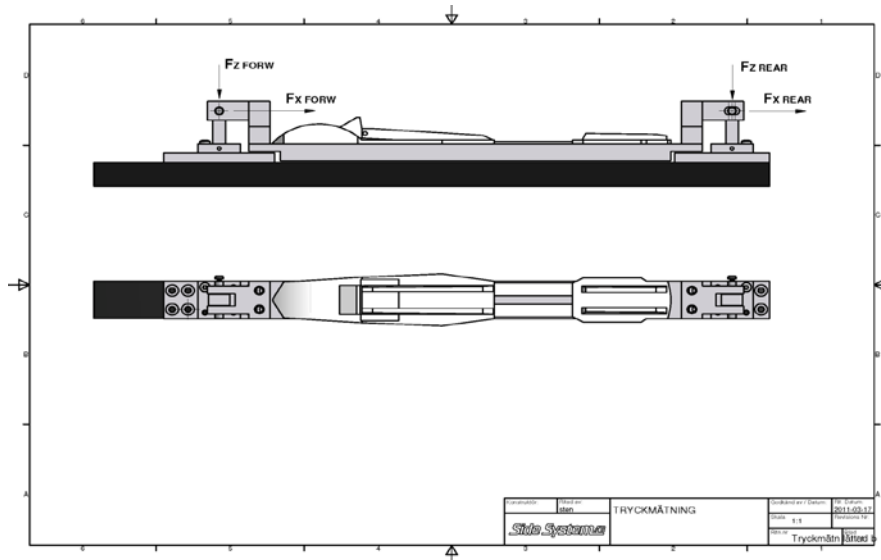

Fig. 8 The force plate measurement system used in the study.

2.1.5 Ergo-spirometry system

The metabolic measurements for $\dot{V}O_2$, respiratory quotient (RQ) and heart rate (HR) were taken using an ergo-spirometry system (AMIS 2001, Innovision A/S, Odense, Denmark) (Jensen *et al.* 2002) and a heart rate monitor (Polar Electro Oy, Kempele, Finland). During all measurements the gas analyzers were calibrated with concentrations that averaged normal expired fractions (O_2 : 16 % with permissible variation ± 0.016 , CO_2 : 4.5 % ± 0.0045 , Air Liquid, Stockholm, Sweden) and the differential pressure sensor for flow measurements was calibrated with a 3L syringe (Hans Rudolph, USA) for flow rates of 1 to 4 $L \cdot s^{-1}$. The system was also calibrated to the present circumstances in the laboratory (ATPS) and the results were standardized and calculated (STPD) according to existing methods (McArdle *et al.* 2001).

The validity and reliability of the ergo-spirometry system was checked using the “Golden standard” Douglas bag method, see Fig. 9.



Fig. 9 Experimental setup of the Douglas Bag system and the metabolic carts used in the studies.

The study showed a 1.7 % higher $\dot{V}O_2$ ($0.05 \text{ L} \cdot \text{min}^{-1} \pm 0.06$, $r = 0.99$, $p = 0.000$) and 0.2 % lower RQ (0.00 ± 0.02 , $r = 0.97$, $p = 0.000$) for the ergo-spirometry system used in the study. The coefficient of variation (CV) of the difference between the two systems showed a variation of 3.5 % and 3.3 % for $\dot{V}O_2$ and RQ, respectively, which is at the same level as that previously reported between the two systems (Jensen *et al.* 2002). Another validity and reliability study was executed during the time period of the studies, with similar results.

The linearity of the ergo-spirometry system's O_2 and CO_2 analyzers was checked at a range that covered almost all of the expired fractions in the studies, using two additional concentrations of O_2 (14 % and 18 %) and CO_2 (3.5 % and 5.5 %). The linearity check showed that the deviation for O_2 was 0.02 and 0.02 percentage units (0.14 %, 0.11 %) respectively, and for CO_2 it was -0.03 and 0.03 (-0.86 %, 0.54 %) respectively, meaning there was a maximum error for the results of $\dot{V}O_2$ due to the analyses of the two gases of less than ~1 % and ~0.2 %, respectively (Withers *et al.* 2000).

2.2 Study designs

Before the tests, the subjects were given instructions on standardized behavior to follow, such as avoiding unfamiliar strenuous exercise the week before the test and not exercising for 24 hours prior to the test. Food intake was to be normal, i.e. not to contain extremes of fats, carbohydrates and protein, and a meal was to be eaten two to three hours before the test was conducted. All the subjects had previous experience of roller skiing on the

treadmill before the physiological testing took place and were informed about the purpose, method and possible risks associated with participation in the upcoming study prior to being given the opportunity to provide written informed consent. Before testing, the subjects filled out a standard health form to declare their physical condition. The experiments on humans (studies II, III and V) were approved by the Regional Ethical Review Board in Umeå, Sweden.

2.2.1 Pilot studies

Initially, for the purpose of consistently and throughout the thesis using a method with high reliability for the collection of the physiological data, a study on two different blood sampling methods and exercise protocols was carried out.

The reproducibility of blood lactate (B-Hla, $\text{mmol} \cdot \text{L}^{-1}$) was checked using 40 paired blood samples collected from 6 subjects from the vena cephalic and from 6 other subjects from capillaries in a fingertip during rest and immediately after 4 to 5 submaximal workloads and a maximal test. Before puncturing the skin of a fore- middle- or ring fingertip, the area was cleaned and disinfected with alcohol and dried with a cellulose swab.

The results showed no significant ($p > 0.05$) difference between the paired measurements for either the venous ($3.6 \pm 3.0 \text{ mmol} \cdot \text{L}^{-1}$) or the capillary samples ($3.4 \pm 2.9 \text{ mmol} \cdot \text{L}^{-1}$). However, reproducibility was better for the former (TEM ; $0.06 \text{ mmol} \cdot \text{L}^{-1}$, 1.72 %) than for the latter (TEM ; $0.15 \text{ mmol} \cdot \text{L}^{-1}$, 4.46 %). Thus, the error of a single measure of B-Hla should be $\pm 0.06 \text{ mmol} \cdot \text{L}^{-1}$ two-thirds of the time for the venous blood sampling technique used in the papers in this thesis.

Furthermore, $\dot{V}O_2$, HR and B-Hla responses were studied as a function of two different protocols, where 5 cross-country skiers at a high national level performed 5 submaximal workloads on the treadmill using the DS technique. The two protocols were identical as regards the speed and inclination of the treadmill. The disparity was that one of the protocols had a one-minute break between the workloads to facilitate the handling of a capillary blood sample (non-continuous protocol, NC), while the other protocol did not have any break between the workloads (continuous protocol, C). For both types of protocol, the HR and $\dot{V}O_2$ results of each workload were averaged from the last minute, while the venous B-Hla of C was sampled during the last 30 s and the capillary B-Hla of NC at the one-minute break. Also, venous B-Hla was sampled simultaneously to the capillary B-Hla during the break in the tests with NC for the purpose of studying the effect of the different protocols when using the same blood sampling technique (venous). The two protocols were tested on two separate days and three out of five subjects started by testing with NC.

The results showed a significantly higher $\dot{V}O_2$ of 1.8 % for C ($3.67 \pm 1.15 \text{ L} \cdot \text{min}^{-1}$) compared to NC ($3.59 \pm 1.09 \text{ L} \cdot \text{min}^{-1}$), whereas there was no difference for HR ($158.1 \pm 29.5, 1 \cdot \text{min}^{-1}$, $155.7 \pm 28.4, 1 \cdot \text{min}^{-1}$, respectively), se Fig. 10.

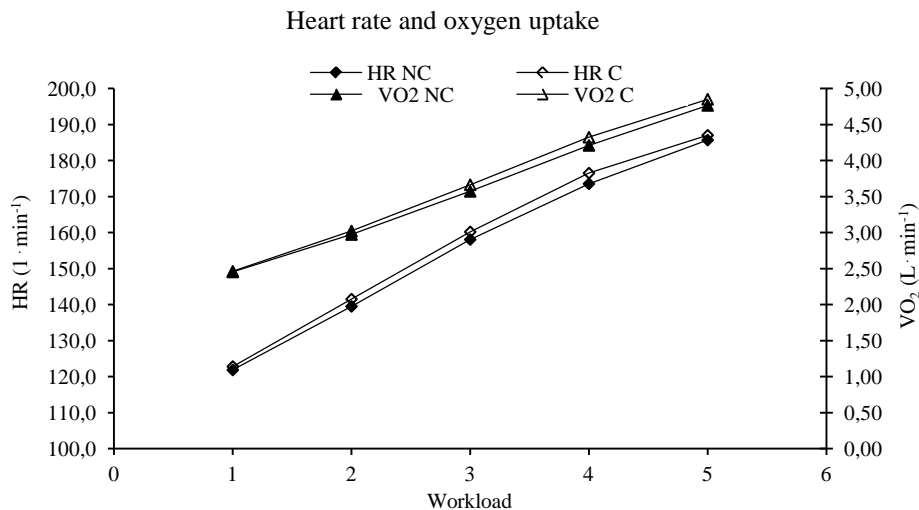

Fig. 10 Heart rate (HR) and oxygen uptake ($\dot{V}O_2$) for the continuous (C) and non-continuous (NC) protocols at five submaximal workloads.

Furthermore, venous B-Hla was 6.8 % lower for C ($2.67 \pm 2.24 \text{ mmol} \cdot \text{L}^{-1}$) compared to the capillary B-Hla for NC ($2.86 \pm 2.10 \text{ mmol} \cdot \text{L}^{-1}$), while there was no difference in venous B-Hla between the two different protocols, see Fig. 11.

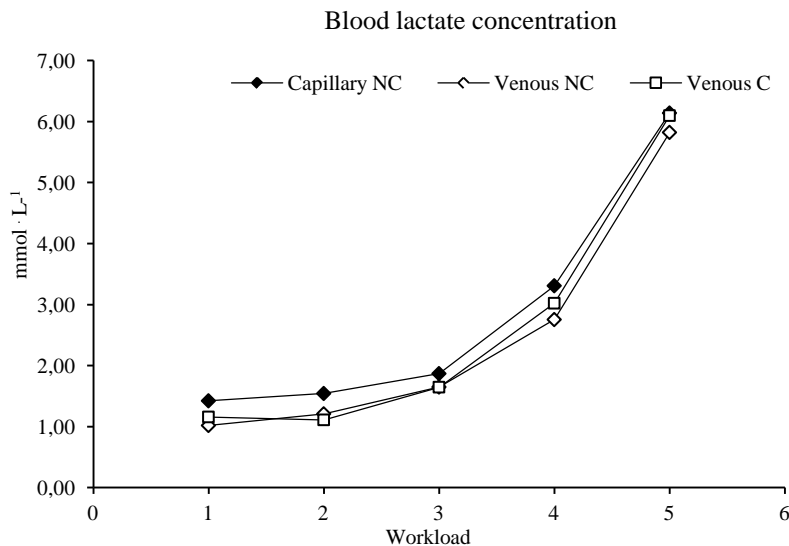

Fig. 11 Blood lactate concentrations (B-Hla) at five submaximal workloads, from capillary and venous blood samples. C and NC denote the continuous and non-continuous protocol, respectively.

The reason for higher concentrations for variables, such as lactate, that are taken from capillary finger blood rather than from venous blood is well known, and is mainly due to filtration and diffusion of plasma between the capillaries and the interstitial fluid (Guyton & Hall 2001). Foxdal (Foxdal 1994) reported a slightly larger difference for B-H1a (~9 %) than that found in this study. A trend can be seen towards an increasing difference between the two protocols in B-H1a, HR and $\dot{V}O_2$ at higher workloads. This is probably due to a slightly larger accumulated fatigue and the $\dot{V}O_2$ slow component when performing C compared to NC (Jones *et al.* 2011).

The results of the pilot studies on blood sampling methods and exercise protocols thus showed that venous sampling is preferable to capillary sampling for B-H1a. The lower reliability of the capillary sampling is probably due to local variations in metabolism and diffusion, which do not reflect the metabolism of larger working muscle groups. The advantages of using a continuous protocol are, besides the ability to use the venous blood sampling method, the avoidance of an unnecessary break between workloads. The metabolism will change rather abruptly if breaks are put in between workloads, due to large fluctuations in metabolic demands. This will entail a later entry to a stable metabolic state on the next coming workload. Thus, a continuous protocol and venous blood sampling method are in many ways preferable and therefore became the choice for the physiological experiments in this thesis.

2.2.2 Assessment of physiological data

The results for $\dot{V}O_2$, HR and RQ were calculated as mean values from the last minute (60 s) of the submaximal workloads, and from 30 s of the adjacent highest values of the maximal tests. Since the $\dot{V}O_2$, for some of the subjects in studies III and V, was not found to attain a clear plateau before the maximal test was ended, a decision was taken to use the definition peak instead of max for the oxygen uptake and heart rate ($\dot{V}O_{2\text{ PEAK}}$ and HR_{PEAK}) from the maximal tests in these studies.

The incremental maximal tests were terminated when the subjects signalled it by taking out their mouthpiece. At this signal, the time to exhaustion (TTE) was noted.

The results of the skiing economy ($\dot{v}O_2$), and the max and peak oxygen uptake per kg mass ($\dot{v}O_{2\text{ MAX}}$, $\dot{v}O_{2\text{ PEAK}}$) were calculated from the sum of the total mass of the equipment (roller skis, ski boots and ski poles) and the body mass (including the testing clothes: shorts, socks and a T-shirt).

Venous blood samples for analyses of B-H1a were taken during the last 30 s of each submaximal workload and one minute after the incremental maximal test ended, using 2 ml syringes from a 200 cm (1.5 ml) extension set (ALARIS medical UK ltd, Hampshire, UK) connected to a catheter (BD Venflon™ Pro 1.3 × 32 mm, Becton Dickinson, Helsingborg, Sweden) in the cephalic vein or, in some cases, in the mediana cubiti vein. Between the samples, the system was flushed with isotonic saline to avoid coagulation, see Fig. 12.

Thus, each sampling started by discharging a volume greater than 3 ml before the actual sample was taken. The B-H1a concentrations were analysed in a laboratory device (Biosen 5140, EKF-Diagnostic, Magdeburg, Germany) within 10 minutes of the test's completion.



Fig. 12 Venous blood sampling during DS roller skiing.

Ratings of perceived exertion (RPE 6-20) (Borg 1998) were carried out for breathing, arms, and legs during the last minute of each submaximal workload and directly after exhaustion.

In studies II and V, the subjects were filmed with a 2-D video camera during the last minute of the submaximal workloads for analyses of cycle rates (CR), i.e. the number of cycles performed per minute. The length (distance) per cycle (CL) was also analysed by dividing the speed ($\text{m} \cdot \text{min}^{-1}$) by CR.

2.2.3 Study I

To study whether a change in μ_R occurs during usage, measurements were taken during one hour of continuous rolling with 12 different roller skis (PRO-SKI, C2 $n = 8$, S2 $n = 4$). A mass of 40.6 kg of lead was put on top of the roller skis in order to simulate the average weight of a person warming up the roller skis, changing between different techniques (double poling, diagonal stride etc.). The mean of μ_R was calculated for 60 seconds every tenth minute, starting with minute one and then normalized, i.e. all the values for each ski were divided by the value for the first minute of the test.

In addition, to see whether the change in μ_R could be explained by a possible change in the temperature (T, °C) of the roller ski's bearings, simultaneous measurements of μ_R and T were carried out with 6 C2 roller skis with three different masses (20.6, 41.5 and 61.5 kg) put on top of the roller skis. The sensor from the thermometer was attached to the surface of the roller ski's rear, close to the wheel bolt.

The coefficient of rolling resistance was also studied with 6 C2 and 6 S2 roller skis as a function of different normal forces on the roller ski, as well as the velocities and inclinations of the treadmill. Before starting to take measurements, the individual roller ski was warmed up for 40 minutes due to the results of the warm-up study.

The reproducibility of the rolling resistance measurement system was tested with a mass of 61.5 kg, using a wide range of treadmill inclinations and velocities. Before starting to take measurements, the individual roller ski was warmed up for 40 minutes due to the results of the warm-up study. Two separate measurements were taken of the same load and between the measurements the treadmill was stopped and the mass and the roller ski were taken off the RRMS equipment. The roller ski and mass were then re-established and a measurement was reproduced using the same load. For each type of roller ski, C2 and S2, this paired procedure was repeated twelve times using different inclinations and velocities of the treadmill.

2.2.4 Study II

A total of twenty elite athletes who competed in cross country skiing, biathlon and ski-orienteeing at a national level volunteered to take part in physiological tests by roller skiing using the G3 or DS techniques. Characteristics of the participants are presented in Table 1.

Table 1 Characteristics of the participants; G3, n = 10 (five women and five men); DS, n = 10 (four women and six men).

	Age [yr]	Body mass [kg]	Body Height [cm]	$\dot{v}O_2$ MAX [mL · kg ⁻¹ · min ⁻¹]	Pole length/Body Height [%]
G3	25.9 ± 5.9	66.99 ± 6.6	174.9 ± 7.6	60.3 ± 6.2	90.2 ± 1.0
DS	26.0 ± 5.1	72.8 ± 11.5	176.5 ± 11.7	63.1 ± 5.4	84.6 ± 0.7

The subjects performed the same type of test on three different test occasions, and there was an average time of 6.4 days (4-12) between each occasion. Two of the test occasions (T1 and T2) were carried out on the same pair of roller skis and on the third occasion (T3) a pair of roller skis with different μ_R was used. The order of the roller skis used was randomized, and the test subjects had no knowledge of the actual μ_R of the roller skis.

On each test occasion the subjects performed two submaximal workloads of 10 minutes each, followed by an incremental maximal test to exhaustion.

In association with the tests using the G3 technique (which took place before the part of the study using the DS technique) the S2 roller skis were warmed up by a non-test person roller skiing on the treadmill for 30 minutes. Before the tests using the DS technique the C2 roller skis were warmed up in a low-temperature oven for at least half an hour to a running temperature corresponding to a certain normal force on the roller skis, $T = 24.43 + 0.0234 \cdot N_{TOTAL}$.

A study to determine μ_R as a function of different normal forces, used for calculations of external power, was completed using masses at 5 kg intervals within the range of 22.7-62.7 kg, corresponding to N_{TOTAL} 222.7-615.1 N. The study established the following relationship and correlations for the freestyle roller skis: T1 and T2 $\mu_R = 0.030438 - 23 \cdot 10^{-6} \cdot N_{TOTAL}$ ($r = -0.970$, $p = 0.000$), T3 $\mu_R = 0.015830 - 12 \cdot 10^{-6} \cdot N_{TOTAL}$ ($r = -0.990$, $p = 0.000$), and for the classical roller skis: T1 and T2 $\mu_R = 0.034790 - 26 \cdot 10^{-6} \cdot N_{TOTAL}$ ($r = -0.987$, $p = 0.000$), T3 $\mu_R = 0.0352635 - 16 \cdot 10^{-6} \cdot N_{TOTAL}$ ($r = -0.996$, $p = 0.000$).

The external power (P_{W_EXT}) from the submaximal workloads (P_W) was calculated in units of watts using the power from elevating the transported mass against gravity (P) and the power from overcoming the rolling resistance coefficient ($P\mu_R$) in the following equation:

$$P_{W_EXT} [W] = P + P\mu_R = mg \cdot v (\sin \alpha + \mu_R \cdot \cos \alpha) \quad (9)$$

where α is the inclination and v is the velocity of the treadmill, expressed in $m \cdot s^{-1}$. Maximal external power output (P_{W_MAX}) performed during the incremental maximal tests was calculated using a method used in bicycle research (Padilla *et al.* 2000) (in Padilla *et al.* $W_{max} = W_f + [(t/240) \cdot 35]$) with the following equation:

$$P_{W_max} [W] = P_W + P_R \cdot (t / 60) \quad (10)$$

where P_R is the relative power output difference between the last two P_W , t is the time (s) the last P_W was maintained and 60 s is the duration of each P_W .

2.2.5 Study III

A total of 88 subjects with various backgrounds in cross-country skiing and biathlon volunteered to take part in the physiological tests using the G3 ($n = 36$) or the DS ($n = 52$) techniques. In each technique the subjects were arranged in five different groups according to their performance ability, age and gender: male recreational skiers (M_{REC}), male and female elite juniors (M_{JUN} and F_{JUN} respectively) and male and female elite seniors (M_{SEN} and F_{SEN} respectively). The selected characteristics of the participants in each group are presented in Table 2.

Table 2 Selected characteristics of the participants in the different groups who tested free technique gear 3 (G3) and classic technique diagonal stride (DS) on roller skis on a treadmill. The $\dot{V}O_2$ PEAK was calculated from the total mass of the equipment (roller skis, ski boots and ski poles) and body mass.

	M _{REC}	M _{SEN}	M _{JUN}	F _{SEN}	F _{JUN}
G3 n =	8	7	7	7	7
Age [yr]	36.1 ± 10.7	25.9 ± 2.5 [†]	18.6 ± 1.3 ^{###}	25.1 ± 6.2 [†]	18.0 ± 1.5 ^{###}
Body height [cm]	180.6 ± 8.0	178.1 ± 4.2	179.1 ± 8.5	165.0 ± 4.4 ^{###SSS}	170.6 ± 4.8 [†]
Body mass [kg]	79.1 ± 11.9	76.1 ± 6.4	72.0 ± 8.6	62.3 ± 4.5 ^{###}	62.1 ± 4.7 ^{###}
Total mass [kg]	82.4 ± 11.9	79.3 ± 6.4	75.2 ± 8.7	65.3 ± 4.5 ^{###}	65.2 ± 4.8 ^{###}
HR _{PEAK} [l · min ⁻¹]	184.5 ± 13.8	195.6 ± 5.0	195.5 ± 15.4	189.4 ± 4.7	194.8 ± 6.2
$\dot{V}O_2$ PEAK [mL · kg ⁻¹ · min ⁻¹]	50.8 ± 4.6	66.3 ± 3.3 ^{###}	64.4 ± 1.8 ^{###}	57.0 ± 8.5 ^{###}	52.6 ± 1.9 ^{###SSS}
$\dot{V}O_2$ OBLA [% $\dot{V}O_2$ PEAK]	75.6 ± 8.7	79.8 ± 5.0	79.1 ± 4.1	82.1 ± 3.4	79.2 ± 5.0
DS n =	13	10	9	10	10
Age [yr]	36.8 ± 10.4	22.0 ± 2.3 ^{###}	17.6 ± 1.3 ^{###}	21.9 ± 1.9 ^{###}	17.9 ± 1.0 ^{###}
Body height [cm]	183.7 ± 5.1	179.4 ± 4.6	183.8 ± 7.8	169.0 ± 5.4 ^{###SSS}	167.0 ± 3.5 ^{###SSS}
Body mass [kg]	82.3 ± 9.0	76.4 ± 6.6	73.6 ± 8.9	62.0 ± 4.5 ^{###SS}	62.9 ± 6.5 ^{###SS}
Total mass [kg]	85.8 ± 9.1	79.8 ± 6.6	77.0 ± 9.0	65.1 ± 4.6 ^{###SS}	66.1 ± 6.5 ^{###SS}
HR _{PEAK} [l · min ⁻¹]	179.6 ± 8.1	192.8 ± 8.4 ^{###}	197.5 ± 8.1 ^{###}	195.6 ± 3.4 ^{###}	199.0 ± 8.0 ^{###}
$\dot{V}O_2$ PEAK [mL · kg ⁻¹ · min ⁻¹]	53.3 ± 4.0	68.5 ± 2.2 ^{###}	64.2 ± 4.2 ^{###}	59.7 ± 1.5 ^{###}	52.9 ± 4.9 ^{###SSS*}
$\dot{V}O_2$ OBLA [% $\dot{V}O_2$ PEAK]	82.2 ± 4.5	84.6 ± 4.2	83.8 ± 2.5	85.3 ± 4.2	86.3 ± 4.1

[†] vs. M_{REC}, [#] vs. M_{SEN}, ^S vs. M_{JUN}, ^{**} vs. F_{SEN}, ^{†, #, S} p ≤ 0.05, ^{###, ##, SS, *} p ≤ 0.01, ^{###, ###, SSS} p ≤ 0.001.

The test protocol began with the subjects performing an incremental submaximal test with four to six workloads of four min each, followed by an incremental maximal test to determine $\dot{V}O_2$ MAX ($\dot{V}O_2$ PEAK). The number of submaximal workloads performed was limited by the subject's skill and maximal aerobic capacity, and the final workload was settled when RQ exceeded 1.0.

In order to minimize the contribution of anaerobic energy, only submaximal workloads with a B-HIa concentration of less than 4 mmol · L⁻¹ (OBLA) at group level were included in the analyses. Accordingly, two different workloads from each technique were analysed; G3₁ and G3₂; DS₁ and DS₂. G3₁ and DS₁ contained all five groups while G3₂ and DS₂ included the three groups M_{SEN}, F_{SEN} and M_{JUN}, since the M_{REC} and F_{JUN} groups did not perform this workload; this was also the case for one subject in the F_{SEN} group in the part of the study that tested G3 roller skiing.

The point where the subjects' OBLA occurred at a percentage of $\dot{V}O_2$ PEAK ($\dot{V}O_2$ OBLA % $\dot{V}O_2$ PEAK) was decided using an exponential interpolating function (Microsoft Excel 2007) where the B-HIa response curve at the different workloads was plotted vs. % of $\dot{V}O_2$ PEAK (4 mmol · L⁻¹ = C · e^{ax}), where C and a are constants and x is the relative % of $\dot{V}O_2$ PEAK.

The $P_{W\ EXT}$ was calculated as described in study II. The following relationships and correlations were established for μ_R for the free and classic technique roller skis, used in the part of the study that tested G3 and DS respectively: G3; $\mu_R = 0.030438 - 23 \cdot 10^{-6} \cdot N_{TOTAL}$ ($r = -0.970, p = 0.000$), DS; $\mu_R = 0.026558 - 12 \cdot 10^{-6} \cdot N_{TOTAL}$ ($r = -0.932, p = 0.000$).

To prepare for calculations of gross efficiency, gross energy expenditure (E_{GROSS}) was established, using thermal equivalents of $\dot{V}O_2$, with the following equation for RQ values between 0.707-1.00 (McArdle *et al.* 2001):

$$E_{GROSS} [K_{CAL} \cdot \min^{-1}] = (1.232 \cdot RQ + 3.8149) \cdot \dot{V}O_2 [L \cdot \min^{-1}] \quad (11)$$

where the E_{GROSS} is the sum of the resting metabolic rate (E_{RMR}) and the requirement of the exercise (E_{NET}) above E_{RMR} . The equivalent of 5.047 for carbohydrate was used for RQ values above 1.00. The E_{GROSS} was converted into internal power ($P_{W\ INT}$) by dividing the E_{GROSS} by 0.01433 (McArdle *et al.* 2001). Finally, the results of gross efficiency were estimated using the following equation:

$$Gross\ efficiency[\%] = \frac{P_{W\ EXT}}{P_{W\ INT}} \cdot 100 \quad (12)$$

In order to investigate whether the roller skis' μ_R were similar or changed during the period the experiments took place, μ_R was checked on each day of testing, i.e. on 21 and 32 different occasions for the G3 and DS roller skis respectively. Linear regression showed that μ_R did not change significantly during the period the experiments took place: G3; $\mu_R = 0.020 + 99 \cdot 10^{-6} \cdot day$ ($p = 0.092$), DS; $\mu_R = 0.025 - 12 \cdot 10^{-6} \cdot day$ ($p = 0.247$).

2.2.6 Study IV

The study used six ratcheted wheel designed roller skis, distributed as one pair from each of three different manufacturers (PRO-SKI C2, Swenor Fibreglass and Marwe Classic). The study also used six roller skis with the adjustable grip function (Camber-skis).

The roller skis' μ_S was studied as a function of different normal forces acting on the wheel with the grip functionality. Forces corresponding to masses within the range of 50 to 150 kg, at 10 kg intervals, were applied on top of the fixtures' aluminium sole on the roller ski, 100 mm behind the ski boot fix point. Together with the mass of the tested roller ski and the sole this corresponded to the total normal forces of: PRO-SKI, 505.2 to 1486.2 N; Swenor and Marwe, 506.2 to 1487.2 N and Camber-Ski, 508.2 to 1489.2 N.

The ratcheted wheel roller skis' μ_S was studied on three different surfaces; 1) rubber mat; 2) dry asphalt; 3) and on wet asphalt, the latter with tap water forming a layer of ~1 to 2 mm thickness, covering the surface.

The Camber-Skis' μ_S was studied on the rubber mat with; 1) the camber adjusted so that the R_S and the forward wheel merely established contact for the initial measuring load, after which the camber was not adjusted, and; 2) with adjustments of the camber in order to determine the spring length for different masses applied on the roller ski, in order to maintain a constant μ_S of 0.2.

The results for the tangential force (S') were based upon a mean of the three adjacent highest values registered. The time from applying the traction to when the peak value occurred was ~ 0.2 s, which is approximately what has been reported from skiing on snow and from treadmill roller skiing (Stoggl *et al.* 2011; Vahasoyrinki *et al.* 2008).

Finally, the reproducibility of the μ_s measurements was tested on the rubber mat using one roller ski of each construction (PRO-SKI and Camber-Ski) and the same F as above ($n=11$). Two separate measurements were taken for the same load and, between the paired measurements, the roller ski was taken off the fixture, re-established and a measurement was reproduced using the same F.

2.2.7 Study V

A total of nine cross-country skiers participated in the physiological tests (Table 3).

Table 3 Selected characteristics of the participants. The total mass was based upon the mass of the skier, ski poles, ski boots and the Camber-Ski roller skis.

Age [yr]	Body height [cm]	Body mass [kg]	Total mass [kg]	Pole length/body height [%]
20.9 ± 2.4	173.3 ± 11.1	70.4 ± 11.1	74.5 ± 11.2	84.9 ± 2.5

The skiers performed the same type of test on 4 different days with 2-4 days between each test occasion. The roller skis used on the different test occasions were: PRO-SKI C2 roller skis with the ratcheted wheel 1) in the, standard, rear position (RW_{REAR}) and 2) in the, alternative, forward position (RW_{FORW}); the Camber-Ski was used with 3) unstrained camber ($\text{Cam}_{\text{UNSTR}}$), with a similar μ_s as the ratcheted wheel roller skis (1-3: $\mu_s = 0.78 \pm 0.09$), and 4) with adjustment of the camber in order to establish a μ_s of 0.2 according to the subject's body mass ($\text{Cam}_{0.2\mu_s}$). The order of the 4 different tests was fully randomized within and between the subjects. Before each test occasion, the roller skis' μ_R was measured, using a mass similar to the subject's body mass, and adjusted to a value of 0.03.

On each of these four test occasions, the subjects performed a submaximal test with two different workloads of ten minutes each. In the first workload (72.5 ± 7.5 % $\dot{V}O_{2 \text{ PEAK}}$) DS was used and in the second workload (73.1 ± 6.6 % $\dot{V}O_{2 \text{ PEAK}}$) DP_{KICK} was used. After the submaximal test an incremental maximal test using DS was executed.

Also, five of the study subjects (3 women and 2 men) who performed the physiological tests volunteered to take part in one more experiment for the purpose of studying the forces applied to the roller skis during skiing at the submaximal workloads. On this test occasion the RW_{REAR} and the $\text{Camber-Ski}_{0.2\mu_s}$ were used, i.e. as for tests 1) and 4) above. Both types of roller skis were supplemented with the force plate measurement system. The force measurements were unilateral (for the right leg), during one minute for each of the two submaximal workloads, DS and DP_{KICK} , respectively, and the order of the two roller skis used was cross-over alternated between the subjects.

The mean tangential and normal forces ($F_{X\text{ MEAN}}$ and $F_{Z\text{ MEAN}}$, N), the tangential and normal force impulses (F_{tX} and F_{tZ} , Ns) and the centre of pressure's motion in the tangential direction (CP_Z , m) were calculated from the time (t , s) at which the roller ski became stationary on the treadmill rubber mat, i.e. as F_X was changing from negative to positive values ($F_X 0$), and up to where the peak tangential force occurred ($F_{X\text{ PEAK}}$). The results for the mean and range of motion of the CP_Z ($CP_{Z\text{ MEAN}}$ and $CP_{Z\text{ ROM}}$, respectively) were put together as the distance in relation to the ski boot fix point. Furthermore, the time between the peak normal force ($F_{Z\text{ PEAK}}$) and the $F_{X\text{ PEAK}}$ was also analysed. Finally, the μ_S was calculated as the ratio between $F_{X\text{ PEAK}}$ and the F_Z registered at $F_{X\text{ PEAK}}$ ($F_{Z\text{ FX PEAK}}$). All results were based upon a mean of five representative motions for each skier.

2.3 Statistical analyses

The statistical analyses were carried out using SPSS for Windows statistical software Release 12.0.1 (pilot study and study I), 16.0 (Douglas Bag vs. Ergo-spirometry study, studies II and III) and 18.0 (studies IV and V) (SPSS Inc., Chicago, Illinois).

In the pilot study, the differences between the two blood sampling methods and between the two protocols were calculated using the paired Student t test. The difference between the ergo-spirometry system and the "Golden standard" Douglas Bag method was evaluated using the coefficient of variation (CV). The Pearson correlation coefficient r was used to measure the linear relationship between the Douglas Bag method and the ergo-spirometry system.

In study I, the changes in μ_R in the warm-up study were calculated using the paired Student t test. The Pearson correlation coefficient r was used to measure the linear dependence for μ_R as function of mass, incline and velocity of the treadmill.

In studies II, IV and V, one-way repeated measures ANOVA with Bonferroni post hoc tests were used for comparisons of the physiological results between the different test occasions and for comparison of the ratcheted wheel roller skis' μ_S between the different surface conditions. The Pearson correlation coefficient r was used to investigate the linear relationship between variables. Also, the paired Student t test was used in study V for the pair wise analyses of the forces applied on the two tested roller skis and in study IV in the reproducibility study.

In study III, the one-way ANOVA with Bonferroni post hoc tests was used for comparisons of economy, gross efficiency and the selected characteristics between the different groups. The Pearson correlation coefficient r was used to measure the linear dependence of μ_R as a function of different normal forces, and to investigate correlations between the selected characteristics and the results of the skiing economy and gross efficiency. Linear regression analysis was used to evaluate any changes in the roller skis' μ_R during the period when the experiments took place.

The methodological errors in the pilot study, studies I and IV, were calculated as an absolute error using Technical Error of Measurement (TEM) (Norton *et al.* 2000), where di

is the difference between the first and second measurement (M1 and M2) and n is the number of paired measurements

$$TEM = \sqrt{\frac{\sum di^2}{2n}} \quad (13)$$

and a relative error as %TEM.

$$\%TEM = \frac{2 \cdot TEM}{(M1 + M2)} \cdot 100 \quad (14)$$

The level of significance was set at $p \leq 0.05$ in all studies. The results in figures, tables and in the text are presented as mean values \pm standard deviations (*SD*).

3 RESULTS AND DISCUSSION

3.1 Study I. Roller skis' rolling resistance coefficients

3.1.1 Warm-up study

The results of the warm-up study showed a significant decrease in μ_R during the first 30 minutes of rolling, and for the following 30 minutes there was no significant change, see Fig. 13. The results also indicate differences in behaviour between the studied classical and freestyle roller skis. The rolling resistance coefficient of the freestyle roller skis decreased faster and to a lower value when compared to classical roller skis. As an average value, the μ_R of the freestyle roller skis decreased to about 60-65 %, while μ_R of the classical roller skis decreased to 70-75 % of their initial value. This difference might be due to the different design of the tyres, as described in section 2.1.1; the classical roller skis had rather wide rubber tyres while freestyle roller skis had thinner, thermoplastic polyurethane tyres.

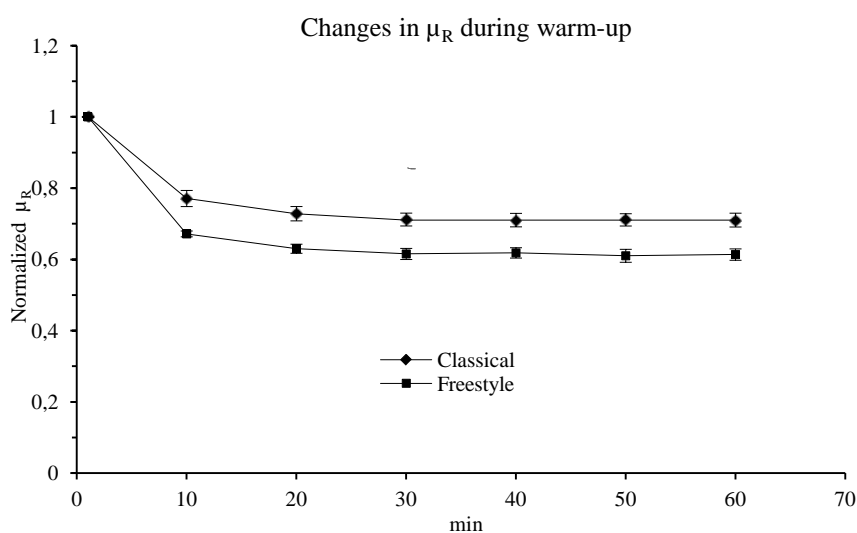

Fig. 13 Normalized coefficient of rolling resistance (μ_R) during warm-up.

For three different loads, the relation between stabilized T and total normal force (N_{TOTAL}) under laboratory conditions was significant and very close to a straight line, with the equation $T = 24.43 + 0.0234 \cdot N_{TOTAL}$. The comparison between T and μ_R changes showed that μ_R decreased as long as T increased and that a stabilized value of μ_R corresponded to a stabilized T (213 N, $r = -0.985$; 418 N, $r = -0.983$; 614 N, $r = -0.957$), see Fig. 14.

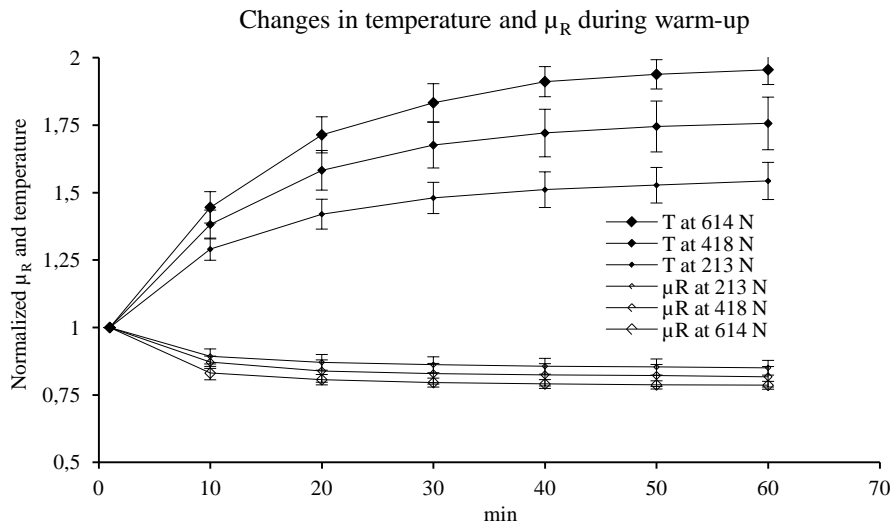

Fig. 14 Normalized temperature (T) and coefficient of rolling resistance (μ_R) during warm-up with different normal forces. Data from classical roller skis.

The study clearly showed that a proper warm-up period for roller skis must precede testing with roller skis on a treadmill, otherwise the results of different physiological tests cannot be compared correctly. The study raised the idea that warming up the roller skis on the treadmill could be replaced by controlled warming in a low-temperature oven. Based on the weight of the skier, the roller skis could be heated to the appropriate temperature and be ready to use at once.

3.1.2 The influence on μ_R of normal force, velocity and inclination

The study of the influence on μ_R of normal force produced a significant correlation between μ_R and normal force for both the classical ($r = -0.978$) and freestyle roller skis ($r = -0.967$). Within the studied range of normal forces, μ_R decreased almost 35-45 % for the classical and the freestyle roller skis, see Fig. 15. With μ_R expressed as a linear function of N_{TOTAL} the following relationship was found for classical and freestyle roller skis within the range of $N_{TOTAL} = 213 - 604$ N:

Classical roller skis: $\mu_R = 0.038626 - 27 \cdot 10^{-6} \cdot N_{TOTAL}$

Freestyle roller skis: $\mu_R = 0.033572 - 28 \cdot 10^{-6} \cdot N_{TOTAL}$

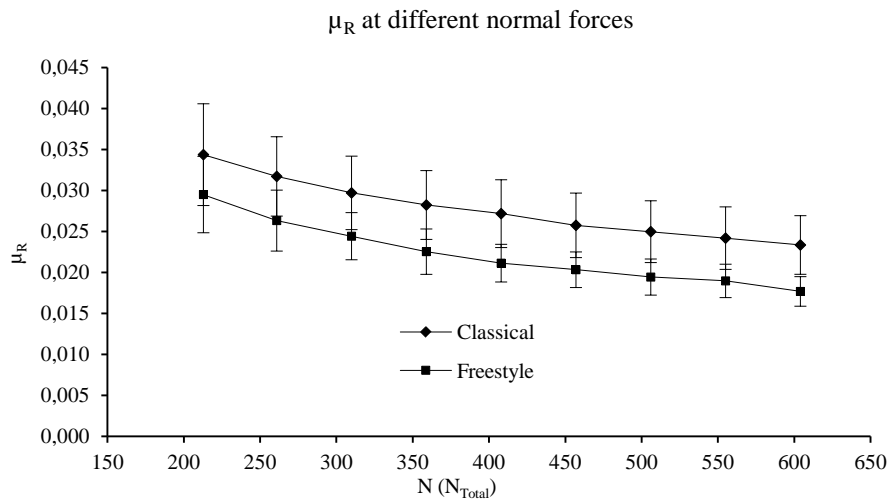

Fig. 15 Coefficient of rolling resistance (μ_R) as a function of different normal forces on the roller skis.

Different velocities of the treadmill only resulted in non-significant changes to μ_R . Raising the velocity from 8 to 28 $\text{km} \cdot \text{h}^{-1}$ resulted in a decrease of μ_R of less than 3 % for the classical ($r = -0.577$) and about 8 % for the freestyle roller skis ($r = -0.611$), see Fig. 16.

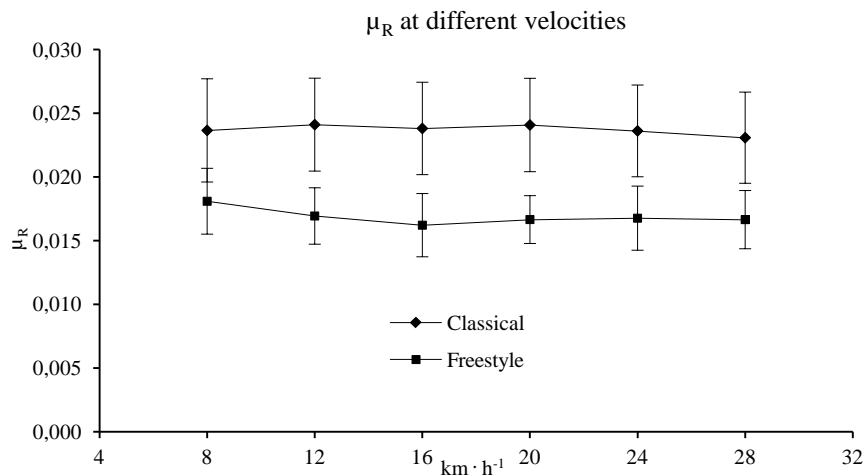

Fig. 16 Coefficient of rolling resistance (μ_R) as a function of different velocities of the treadmill.

A study with a raised incline α from 0° - 9° produced a significant increase of μ_R of about 8 % for classical ($r = 0.889$) and a non-significant increase of 2 % ($r = 0.447$) for the freestyle roller skis, see Fig. 17.

In contrast to earlier studies (Hoffman *et al.* 1990a; Hoffman *et al.* 1994; Hoffman *et al.* 1995; Millet *et al.* 1998), this study showed a clear negative correlation between normal

force and μ_R . This phenomenon, along with the small positive correlation between inclination and μ_R (higher inclination means lower total normal force), is probably explained by a raised T in the roller bearings because of higher normal forces. Raised T in the bearings results in lower viscosity in the grease (Hamrock *et al.* 2004), which results in lower rolling resistance. Increased velocity is also followed by increased heating in the roller bearing, resulting in lower μ_R . Greater changes in μ_R probably require higher velocities.

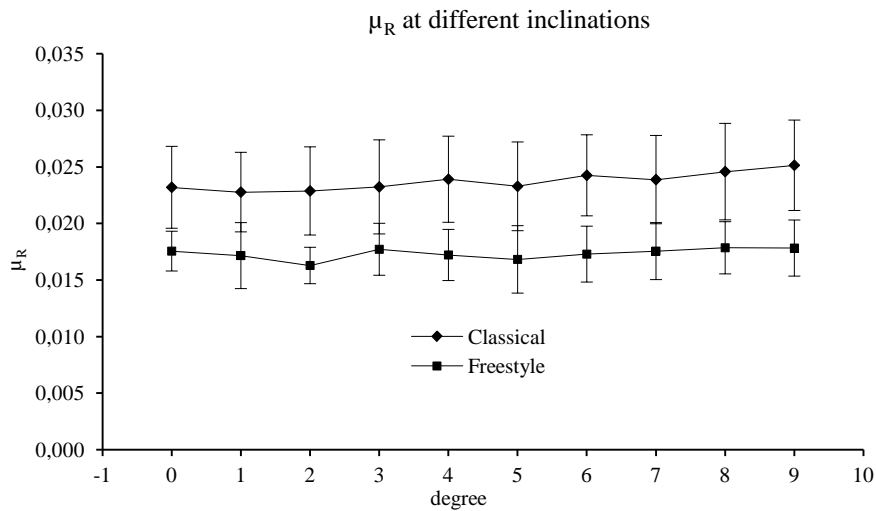

Fig. 17 Coefficient of rolling resistance (μ_R) as a function of different inclinations of the treadmill.

The error bars ($\pm SD$) in Fig. 15, 16 and 17, gave a reflection of the variation in μ_R among the tested roller skis of the same model from the same manufacturer. The difference between the individual roller skis was of a magnitude up to 0.0007 and 0.0010 μ_R (28 % and 34 %) for the freestyle and classical roller skis, respectively. The differences follow the different rolling ages of the roller skis (rolling ages not shown here). This is normal behaviour for roller bearings. They have a breaking in period when they are new, and during that period the rolling resistance slowly sinks as they become more and more used (SKF 2006).

The results of the reproducibility study showed no significant difference between the paired measurements with either the classical or the freestyle roller ski and the *TEM* was relatively small, especially for the classical roller ski (*TEM*, 0.00037 μ_R , 2.27 %). The higher *TEM* for the freestyle roller ski (*TEM*, 0.00058 μ_R , 4.84 %) might be due to a different tyre design, as discussed above. Another possible explanation might be the difference between the protocols used, where the freestyle roller ski protocol used higher velocities than the classical roller ski protocol. Greater vibrations in the treadmill and therefore in the RRMS fixture were observed at higher velocities.

3.2 Study II. Physiological responses to different rolling resistance coefficients

3.2.1 Rolling resistance coefficients

Measurements to check the roller skis' μ_R showed that the two test occasions, T1 and T2, in the freestyle and classical part of the study, carried out on the same pair of freestyle and classical roller skis respectively, were accomplished with non-significant differences in μ_R ; Freestyle roller skis: T1 $\mu_R = 0.01772$, T2 $\mu_R = 0.01707$, Classical roller skis: T1 $\mu_R = 0.01969$, T2 $\mu_R = 0.01974$, see Fig. 18.

The test occasions carried out on a different pair of roller skis, T3, were accomplished with significantly different μ_R , which was 47 % lower for the freestyle roller skis used in the freestyle part of the study, T3 $\mu_R = 0.00941$ and 50 % higher for the classical roller skis used in the classical part of the study, T3 $\mu_R = 0.02949$, see Fig. 18.

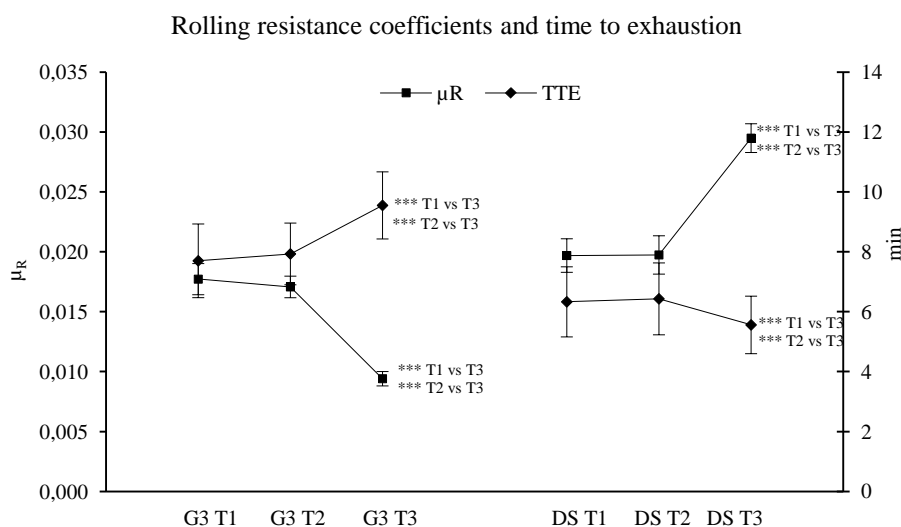

Fig. 18 Rolling resistance coefficients (μ_R) for the freestyle and classical roller skis, used in the freestyle gear 3 (G3) and in the classical diagonal stride (DS) part of the study, respectively, and the time to exhaustion (TTE) from the incremental maximal tests, on the three test occasions (T1, T2, T3). *** $p \leq 0.001$.

These results for μ_R gave a good opportunity to study the reproducibility and significance of the athletes' performance between different test occasions with non-significant variation in μ_R , putting this in relation to the results from the test occasion that was carried out with a significantly different μ_R .

3.2.2 The influence of μ_R on steady state exercises

A comparison between the two test occasions carried out on the same pair of roller skis with no significant difference in μ_R , T1 vs. T2, resulted in non-significant differences for

P_w , $\dot{V}O_2$, HR and B-HIa, see Fig. 19 to 22, and for CL, RPE breathing, arms and legs (results not shown here). Only CR, in the first submaximal workload in the freestyle part of the study, showed a significantly changed result, see Fig. 23.

The use of different pairs of roller skis with 47 % lower and 50 % higher μ_R , on the third, T3, G3 and DS test occasions respectively, resulted mostly in significantly changed P_w , $\dot{V}O_2$, HR and B-HIa at the submaximal workloads.

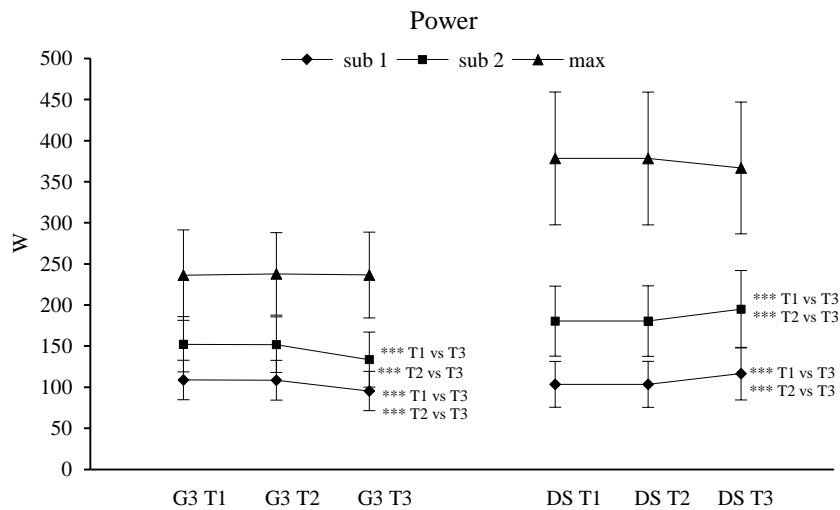

Fig. 19 Power (P_w) from two submaximal workloads (sub 1, sub 2) and from an incremental maximal test (max) on three test occasions (T1,T2,T3) using freestyle gear 3 (G3) and classical diagonal stride (DS) techniques on roller skis. *** $p \leq 0.001$.

P_w decreased by an average of 12.2 % in both submaximal workloads in the freestyle part of the study and increased by 12.6 % and 8.0 % in the first and second submaximal workloads respectively, in the classical part of the study, see Fig. 19.

$\dot{V}O_2$ decreased by 7.4-9.4 % in the freestyle part of the study and increased by 5.4-6.8 % in the classical part of the study, see Fig. 20. This result clearly shows that control of the roller skis' μ_R must be carried out in association with tests of skiing economy, for example, otherwise results cannot be accurately compared.

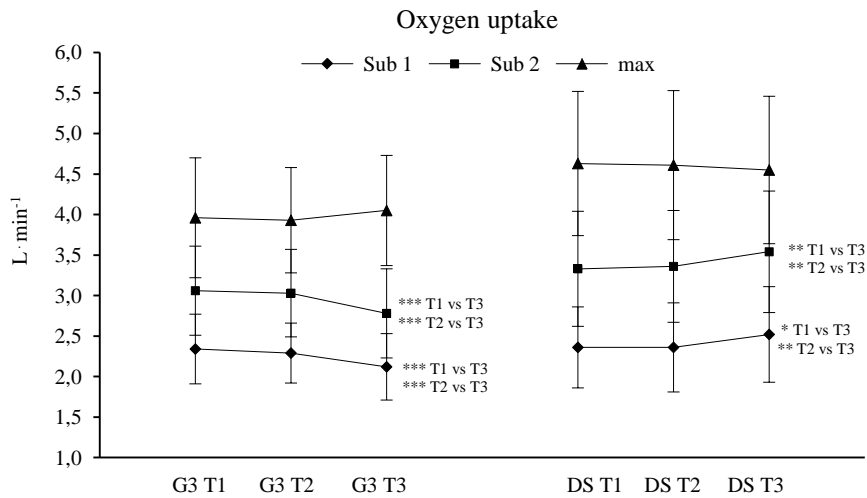

Fig. 20 Oxygen uptake ($\dot{V}O_2$) from two submaximal workloads (sub 1, sub 2) and from an incremental maximal test (max) on three test occasions (T1, T2, T3) using freestyle gear 3 (G3) and classical diagonal stride (DS) techniques on roller skis.
 * $p \leq 0.05$, ** $p \leq 0.01$, *** $p \leq 0.001$.

HR was significantly changed in the second submaximal workloads, except for T2 vs. T3 in the classical part of the study, while there were no differences in the first submaximal workloads, except for T2 vs. T3 in the freestyle part of the study, which was significantly changed, see Fig 21.

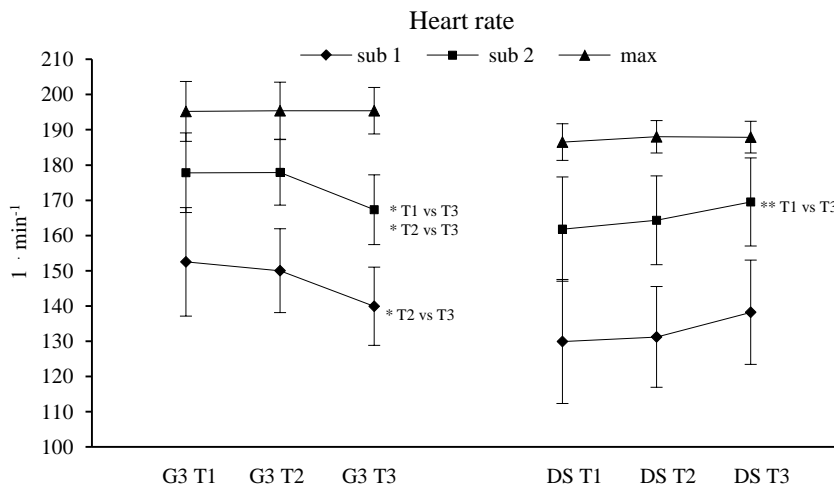

Fig. 21 Heart rates (HR) from two submaximal workloads (sub 1, sub 2) and from an incremental maximal test (max) on three test occasions (T1, T2, T3) using freestyle gear 3 (G3) and classical diagonal stride (DS) techniques on roller skis. * $p \leq 0.05$, ** $p \leq 0.01$.

HR decreased by 5.9-8.3 % in the freestyle part of the study and increased by 3.2-6.4 % in the classical part of the study. Åstrand and Rodahl (Åstrand & Rodahl 1986) mention that emotional factors can affect heart rate during light and moderate intensity exercise, and during repeated maximal exercise the heart rate is, however, remarkably similar under a range of conditions. Also, a variation in heart rate at a given oxygen uptake at rest and during submaximal exercise often produces a change in stroke volume so that cardiac output is maintained at an appropriate level.

B-Hla concentrations were significantly changed in the second submaximal workloads, while differences in the first submaximal workloads were mostly non-significant, see Fig. 22. B-Hla decreased by 20.3-38.8 % in the freestyle part of the study and increased by 14.6-46.6 % in the classical part of the study.

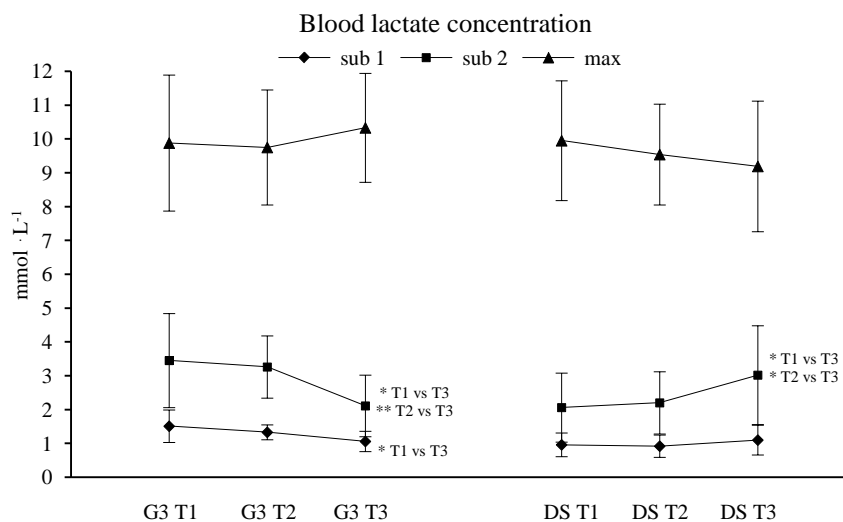

Fig. 22 Blood lactate (B-Hla) concentrations from two submaximal workloads (sub 1, sub2) and after an incremental maximal test (max) on three test occasions (T1, T2, T3) using freestyle gear 3 (G3) and classical diagonal stride (DS) techniques on roller skis. * $p \leq 0.05$, ** $p \leq 0.01$.

This partially unequal result for B-Hla between the freestyle and classical part of the study, and between the two submaximal workloads, can be explained by differences in $\% \dot{V}O_{2\text{MAX}}$ and how lactate responds to increased workload. The classical part of the study had an easier first workload than the freestyle part of the study ($\sim 51\% \dot{V}O_{2\text{MAX}}$ and $\sim 59\% \dot{V}O_{2\text{MAX}}$, respectively). Consequently, the B-Hla concentration was lower in the first submaximal workload in the classical than in the freestyle part of the study. The B-Hla response curve does not have a linear increase, in contrast to HR and $\dot{V}O_2$, with a linear increase in exercise (Bourdon 2000). For elite athletes performing incremental light to moderate exercise there may be a baseline where lactate does not increase significantly with an increase in workload. During harder exercise, the ratio of increased lactate to increased workload

changes quickly due to oxygen deficiency. B-HIa is thus more sensitive to a change in μ_R during harder exercise, as can be seen in Fig 22. At an intensity of $\sim 75\%$ of $\dot{V}O_{2\text{ MAX}}$, on the second submaximal workloads, this study showed that B-HIa changed $\sim 40\%$ to a $\sim 50\%$ decrease or increase in μ_R .

In most cases, RPE resulted in non-significant differences between the three test occasions (results on RPE not presented here). Only RPE for breathing and arms (only T2 vs. T3), in the second submaximal workload in the classical part of the study, showed a significant change between test occasions with significantly different μ_R . RPE for breathing decreased by 3.8-8.7 % in the freestyle part of the study and increased by 0.0-8.4 % in the classical part of the study. RPE for arms decreased by 4.8-8.3 % in the freestyle part of the study and increased by 2.3-7.1 % in the classical part of the study. RPE for legs decreased by 1.0-4.8 % in the freestyle part of the study and increased by 0.7-5.1 % in the classical part of the study.

The earlier interpretation that lactate is the actual cause of muscle fatigue has become controversial (Allen *et al.* 2008; Place *et al.* 2010). However, it is well known that high intensity exercise (high energy requirements) is partially generated by anaerobic metabolism, which leads to lactate accumulation with a relation to muscle fatigue (McArdle *et al.* 2001). In this study the significant change of 35-46 % for B-HIa in the second submaximal workloads, due to an increased anaerobic metabolism, was in most cases not large enough for the participants to rate (RPE) a significantly changed muscle fatigue.

In most cases CR and CL were non-significantly different between the test occasions. However, a difference was found for CR in the first submaximal workload in the freestyle part of the study, between the two test occasions with no difference in μ_R , see Fig. 23.

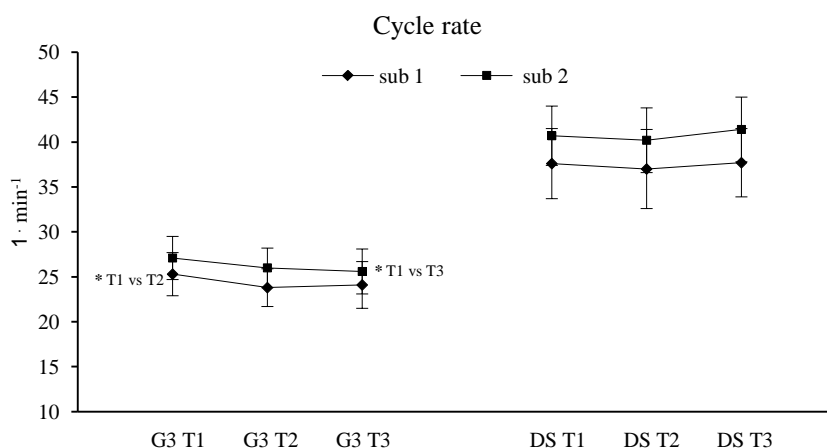

Fig. 23 Cycle rates (CR) from two submaximal workloads (sub 1, sub 2) on three test occasions (T1, T2, T3) using freestyle gear 3 (G3) and classical diagonal stride (DS) techniques on roller skis. * $p \leq 0.05$.

Between the test occasions with different μ_R , only T1 vs T3 in the second submaximal workload in the freestyle part of the study resulted in significant changes for CR and CL. In the first submaximal workload, in the freestyle part of the study, CR on average both decreased by 4.7 % and increased by 1.3 % and CL both decreased by 0.8 % and increased by 5.4 %. In the classical part of the study CR increased on average by 0.3-3.0 % and CL decreased by 0.3-2.8 %.

There are three possibilities for adaptation to a change in μ_R (or a change in velocity and/or inclination of the treadmill); to change CR or CL independently or CR and CL together. The results of this study showed that the latter alternative was chosen by the athletes, and of course a change in μ_R is of lesser importance when distributed over two variables rather than a single variable. A comparison between the first and second submaximal workload for CR vs. $\dot{V}O_2$ and P_W shows that an increase in $\dot{V}O_2$ of ~32 % and ~40 % and in P_W by ~42 % and ~75 %, for the freestyle and classical part of the study respectively, only increases CR by ~8 %. Thus the significant change in P_W of 8-12 % within the same workload, due to the significant change in μ_R , obviously had little influence on CR.

3.2.3 The influence of μ_R on incremental maximal tests

Between the incremental maximal tests that tested freestyle G3 and classical DS technique roller skiing with no differences in μ_R , T1 vs. T2, there were no differences in TTE, $P_{W\ MAX}$, $\dot{V}O_{2\ MAX}$, $HR_{\ MAX}$, and B-HIa, see Fig. 18-22, and for RPE breathing, RPE arms and RPE legs.

The use of different pairs of roller skis with 47 % lower and 50 % higher μ_R , on the third G3 and DS test occasions, T3, respectively, resulted in a significantly changed TTE on the incremental maximal tests, see Fig. 18. TTE increased by 20.4-24.0 % and decreased by 12.2-13.5 % in the freestyle and classical part of the study, respectively. This result clearly shows that TTE is greatly influenced by changes in μ_R and that whenever this variable is evaluated it is important to control the roller skis' μ_R .

This change in TTE occurred without changes in $P_{W\ MAX}$, $\dot{V}O_{2\ MAX}$, $HR_{\ MAX}$ and B-HIa, see Fig. 19-22, and RPE except for the arms (T2 vs. T3) in the classical part of the study. Thus, $P_{W\ MAX}$, when changing μ_R and the power for overcoming the rolling resistance (P_{μ_R}), is almost fully compensated by a change in power from elevating the transported mass against gravity (P). It is perhaps not surprising that μ_R had very little influence on $\dot{V}O_{2\ MAX}$ since a non-significant change in $\dot{V}O_{2\ MAX}$ with protocols of different durations and designs has been reported in other situations (Roffey *et al.* 2007; Zhang *et al.* 1991).

It is difficult to compare the results of the present study with similar studies since the present study was carried out in stationary conditions, while a comparative study measured the roller skis' μ_R on a treadmill using a different method and with the physiological measurements carried out outdoors on asphalt, i.e. on a different surface with an unknown friction between the roller skis and the surface (Hoffman *et al.* 1998). Outdoor measurements also imply air resistance and often a varying ambient and surface

temperature. The results presented in section 3.1.1 showed that μ_R is temperature dependent. In Hoffman *et al.* (1998) the ambient temperature ranged from 15.2 to 36.8 °C during testing. Nevertheless, the results in this study showed a change in $\dot{V}O_2$ of ~7 % for a 50 % change in μ_R , which is quite similar to that reported by Hoffman *et al.* (1998) (13 % to a 100 % increase in μ_R), while HR in this study showed a change of ~6 %, which is more than double the comparative (5 % to a 100 % increase in μ_R). The external power output in this study was changed by 8-12 % due to the 50 % change in μ_R , while Hoffman *et al.* (1998) presented a change of 17 % to a 100 % increase in μ_R .

3.3 Study III. Economy and efficiency in recreational and elite skiers

The results over the different testing groups showed that skiing economy was significantly poorer in G3₁ and DS₁, ~12 % and ~10 %, respectively, for M_{REC} compared with M_{SEN} and F_{SEN}, while no statistical difference was found for M_{REC} compared with M_{JUN} and F_{JUN} in economy in either of the two techniques, see Fig 24. However, when the two junior groups were combined (M_{JUN} + F_{JUN}) and compared with the M_{REC}, the juniors had significantly better economy (~6 %) in G3₁ and DS₁. Furthermore, gross efficiency was ~18 % and ~12 % lower in G3₁ and DS₁ respectively, for M_{REC} compared with M_{SEN} and F_{SEN} and ~12 % and ~8 % lower in G3₁ and DS₁ respectively, compared with M_{JUN} and F_{JUN}, see Fig. 25.

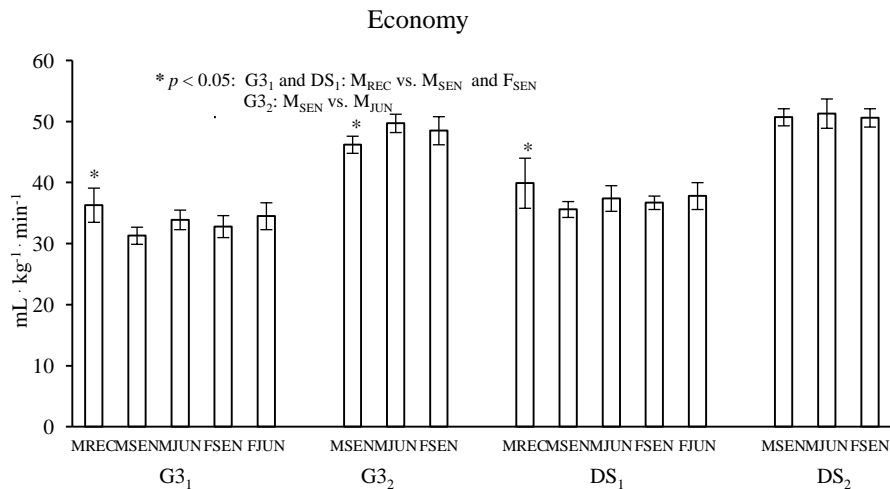

Fig. 24 Economy ($\dot{V}O_2$) for the different groups that tested freestyle gear 3 (G3) and classical diagonal stride (DS) techniques on roller skis at two different workloads (₁ and ₂). M_{REC} = Male recreational skiers, M_{SEN} = Male elite seniors, M_{JUN} = Male elite juniors, F_{SEN} = Female elite seniors, F_{JUN} = Female elite juniors.

Between the separate groups of elite athletes there was no significant difference in economy and gross efficiency in either of the two techniques and workloads, except for economy in G3₂ between M_{SEN} and M_{JUN}. However, when the two senior groups were combined

($M_{SEN} + F_{SEN}$) and compared with the two groups of juniors ($M_{JUN} + F_{JUN}$) the seniors had 4-5 % better economy and higher gross efficiency in $G3_1$ and DS_1 . When the genders were compared with each other using a combination of testing groups ($M_{SEN} + M_{JUN}$ vs. $F_{SEN} + F_{JUN}$), still no differences were observed.

The economy and gross efficiency ranges were large in all the tested groups. In $G3_1$ and DS_1 , a range of 17 to 27 % was found for M_{REC} and 9 to 22 % for the M_{SEN} , F_{SEN} , M_{JUN} and F_{JUN} . This is a smaller range than previously reported for economy for V1 (gear 2), DP_{KICK} and DP techniques on roller skis (Hoffman *et al.* 1990b) and for DS on snow (Macdougall *et al.* 1979).

Our findings, that there was no difference in economy and gross efficiency between the genders, agrees with earlier investigations on economy for DS found on snow (Macdougall *et al.* 1979) and on delta efficiency for DS on roller skis (Hoffman *et al.* 1995). In the latter case there was a gender difference found for the DP technique, but the number of female participants was only two and four for DS and DP respectively.

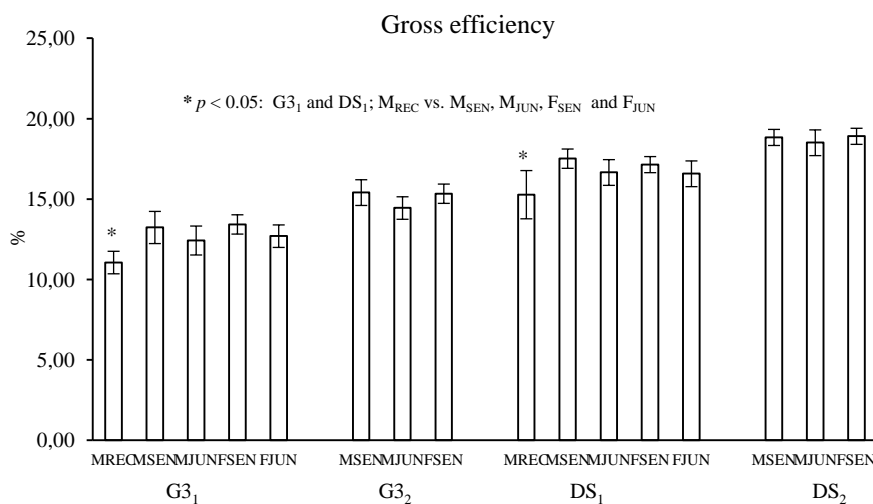

Fig. 25 Gross efficiency (%) for the different groups that tested freestyle gear 3 ($G3$) and classical diagonal stride (DS) techniques on roller skis at two different workloads ($_1$ and $_2$). M_{REC} = Male recreational skiers, M_{SEN} = Male elite seniors, M_{JUN} = Male elite juniors, F_{SEN} = Female elite seniors, F_{JUN} = Female elite juniors.

It is difficult to translate a 10 or 20 % range in economy and gross efficiency to a “real” effect in racing speed. However, from the calculations it can be stated that a certain range in economy has a consequence proportional to $\dot{v}O_2$ and the time spent in the race. The greater the difference in $\dot{v}O_2$ and the longer the competition time, the more influence skiing economy has on the time difference between the competitors. Also, a range in percent in gross efficiency gives an equal range in percent in $\dot{v}O_2$, if the athletes are skiing at similar speeds and other factors are equal. For example, for elite male cross-country skiers with a

similar $\dot{V}O_{2\text{ PEAK}}$ of $80\text{ ml} \cdot \text{kg}^{-1} \cdot \text{min}^{-1}$ and a utilization fraction around 90 %, a range of 10 % in gross efficiency gives a range in $\dot{V}O_2$ of $\sim 7\text{ ml} \cdot \text{kg}^{-1} \cdot \text{min}^{-1}$ at similar speeds. Furthermore, for recreational skiers with a similar $\dot{V}O_{2\text{ PEAK}}$ of 50 and a utilization fraction around 80 %, a range of 20 % in gross efficiency reflects a difference in $\dot{V}O_2$ of $\sim 8\text{ ml} \cdot \text{kg}^{-1} \cdot \text{min}^{-1}$ at similar speeds. In both examples, there is a difference in calorie expenditure of ~ 2.5 to $3\text{ kcal} \cdot \text{min}^{-1}$.

However, differences in relative racing speeds are also due to a relative contribution of anaerobic energy (Mygind *et al.* 1994; Norman *et al.* 1989) and psychological factors. Also, the pw_{EXT} between and within competitors varies due to factors like the friction between the skis and the snow, the drag force and head or tail winds and track profile in relation to anthropometrics (Bergh 1987; Bergh & Forsberg 1992; Carlsson *et al.* 2011). Also, mass starts are now common in World Cup races as well as in the FIS Marathon Cup and hobby races, so a position in front of or behind other competitors (drafting) will cause heart rate to vary considerably, indicating differences in oxygen consumption and energy expenditure (Bilodeau *et al.* 1994). All these factors more or less influence the utilization fraction and may thus increase, reduce or eliminate the gap due to a difference in economy and gross efficiency between individuals.

Interestingly, there was no difference in $\dot{V}O_{2\text{ OBLA}}$ between the five different testing groups and, despite there being large ranges for $\dot{V}O_{2\text{ OBLA}}$ and the economy and gross efficiency, no correlation was found between them. Thus the fraction of $\dot{V}O_{2\text{ PEAK}}$ at OBLA seems not to be different between recreational and elite cross-country skiers during treadmill roller skiing, nor is it necessarily connected to good or poor skiing economy and gross efficiency. On the other hand, an increased level of blood lactate is an indicator of an increased anaerobic metabolism with a relationship to muscle fatigue (Allen *et al.* 2008; McArdle *et al.* 2001). Thus, individual differences in $\dot{V}O_{2\text{ OBLA}}$ will probably also to some extent influence the utilization fraction.

Furthermore, there was a time difference of ~ 3 hours between the recreational skiers who participated in this study, and the normal winning time (~ 4 hours) for the elite competitors in the 90 km Vasaloppet race. Thus, a 15 % difference in economy and gross efficiency between the elite male seniors and the recreational skiers would account for about 50 minutes of the time difference in this race. Together with the 25 % difference in $\dot{V}O_{2\text{ PEAK}}$ between these two categories, this would explain about a total of about 2 hours and 10 minutes time difference in the race, consequently leaving the remaining 50 minutes to the other factors discussed above.

Considering the normal time difference between the male and female winners in Vasaloppet (~ 20 - 30 min), and that this study showed no difference in economy and gross efficiency between the genders, this could almost entirely be explained by the difference in $\dot{V}O_{2\text{ PEAK}}$ between the genders.

While $\dot{V}O_{2\text{ MAX}}$ often can be improved among recreational skiers, it tends not to increase for senior elite athletes in endurance sports after some years of hard training. However, the

economy and gross efficiency of skiing can be improved for both elite and recreational skiers throughout their career, as long as there are highly motivated skiers and coaches, as well as good knowledge and strategies for further development. Besides, cross-country skiing, in comparison to running and cycling, involves many different core-techniques, meaning that there are greater advantages and opportunities, but at the same time it is more difficult to obtain a world class, efficient skiing technique in all of the existing core-techniques.

3.4 Study IV. Classical style roller skis' grip

Within the studied range of vertical loads (F), the ratcheted wheel roller skis showed results of μ_s of 0.81 ± 0.09 for the treadmill rubber mat and 1.05 ± 0.11 and 0.92 ± 0.07 for dry and wet asphalt surfaces, respectively, see Fig. 26 and 27. This is about 5 to 8 times the values reported from on-snow skiing (Ekstrom 1981; Komi 1985; Komi & Norman 1987; Vahasoyrinki *et al.* 2008).

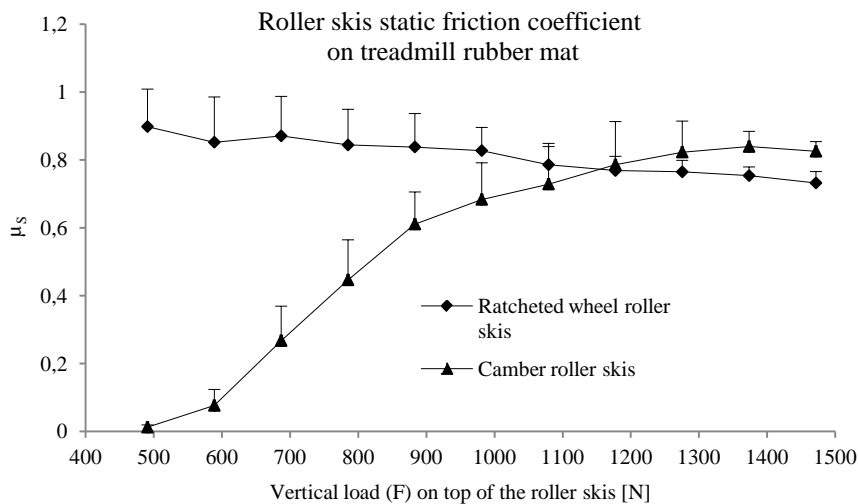

Fig. 26 Results for static friction coefficients (μ_s) on a treadmill rubber mat for the ratcheted wheel roller skis and the Camber-Ski roller skis.

Therefore, the problem with ratcheted wheel designed roller skis is, regardless of the statistical differences between the different surface conditions, that this mechanism provides an excessively high μ_s under conditions normally used for training and for research, even when roller skiing with a poorly performed technique. This is in great contrast to on-snow skiing on groomed trails, where a proper technique is essential for good grip, i.e. where a good grip is far less than for ratcheted wheel roller skis. Also, the high μ_s for ratcheted wheel roller skis does not negatively affect the rolling resistance, which is also a great contrast to grip-waxed cross-country skis, where an improved grip results in a change for the worse in the skis' gliding ability. A μ_s in cross-country skis that is similar to

ratcheted wheel roller skis would probably lead to a very poor glide, which would not make the cross-country skis (the skier) competitive.

For the Camber-Skis tested on the treadmill rubber mat, μ_s changed from nothing up to the level of the ratcheted wheel roller skis with the following equation: $\mu_s = -0.000001F^2 + 0.003F - 1.29$ ($R^2 = 0.98$), see Fig. 26.

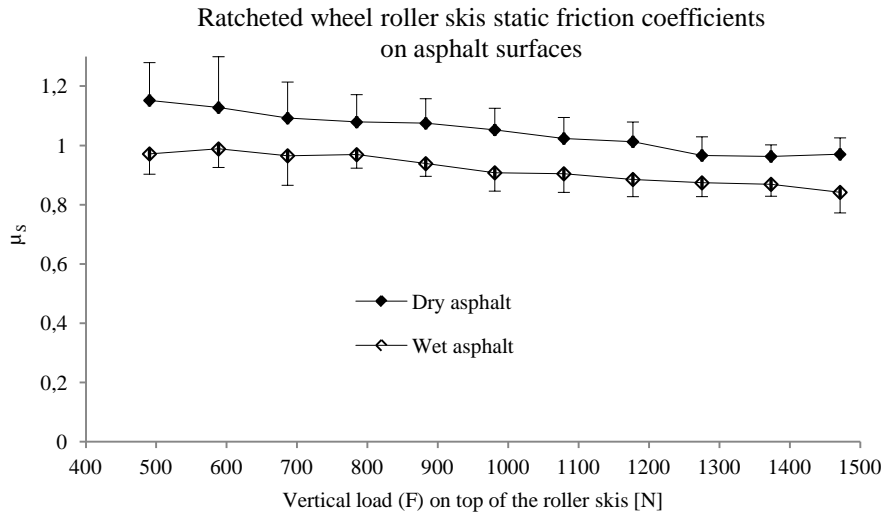

Fig. 27 Results for static friction coefficients (μ_s) on dry and wet asphalt surfaces for the ratcheted wheel roller skis.

Furthermore, when a stationary μ_s of 0.2 was confirmed in the fixture, the following length (L, mm) of the spring was established for the Camber-Ski roller skis: $m = 50-110$ kg; $L = -0.12m + 54.95$ ($R^2 = 0.99$), $m = 110-150$ kg; $L = -0.00008m^3 + 0.035m^2 - 4.88m + 266.4$ ($R^2 = 0.98$), where m corresponds to masses (kg) for different skiers. Furthermore, after the mass was removed, the following length of the spring was established: $m = 50-110$ kg; $L = -0.12m + 57.37$ ($R^2 = 0.99$), $m = 110-150$ kg; $L = -0.00009m^3 + 0.039m^2 - 5.33m + 287.7$ ($R^2 = 0.98$).

The results for the Camber-Skis showed that μ_s , with this type of construction, can be varied within a range of no grip at all up to the level of the tested ratcheted wheel roller skis. By using different cross knurling patterns for the R_s , the friction between the R_s and the forward wheel can also be affected. A smaller knurling or entirely smooth R_s would probably cause reduced friction (more gliding) between the R_s and the forward wheel and thus a slower increase in μ_s , for different F, and possibly a lower peak value.

The reproducibility study showed a significant difference between the paired measurements for the ratcheted wheel roller ski, while there was no significant difference for the Camber-Ski. The TEM for the ratcheted wheel roller ski was found to be; TEM: $0.063 \mu_s$, 5.46 %, and for the Camber-Ski; TEM: $0.040 \mu_s$, 5.16 %.

3.5 Study V. The influence of grip on economy and leg forces

3.5.1 The influence of μ_s on physiological measures

The economy and HR were similar for RW_{REAR} , RW_{FORW} and Cam_{UNSTR} roller skis during both DS and DP_{KICK} techniques. Accordingly, skiing economy during DP_{KICK} was highly correlated between all four tests using different roller skis and also in DS between the RW_{REAR} , RW_{FORW} and Cam_{UNSTR} roller skis, see Fig. 28 and 29. However, the $Cam_{0.2\mu s}$ roller skis resulted in a significantly poorer economy ($\sim 14\%$ higher $\dot{V}O_2$) and a higher HR ($\sim 7\%$) and RPE_{BREATH} (only DP_{KICK} , $\sim 14\%$), while there were only trends towards a higher B-HIa, CR, RPE_{ARM} , RPE_{LEG} and a shorter CL with the use of the $Cam_{0.2\mu s}$ roller skis (results not shown here). Furthermore, the correlation for economy between $Cam_{0.2\mu s}$ vs. the RW_{REAR} , RW_{FORW} and Cam_{UNSTR} roller skis was poorer in DS, see Fig. 28.

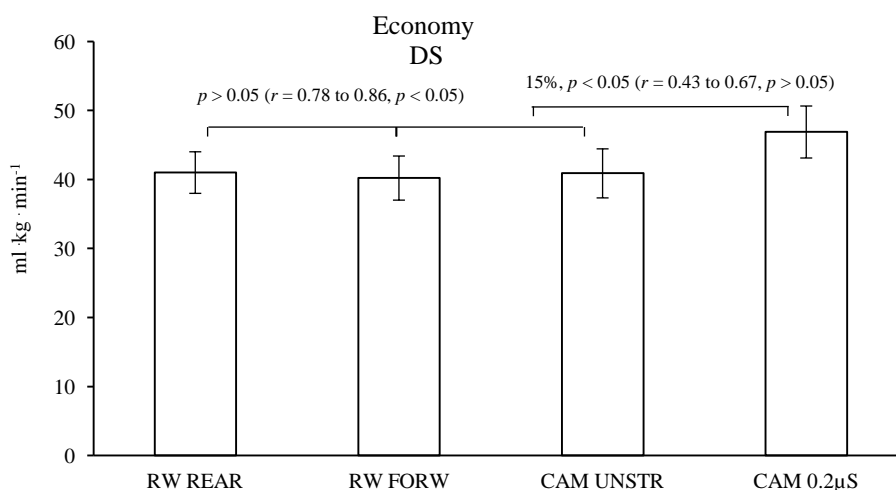

Fig. 28 Results of economy ($\dot{V}O_2$) when using diagonal stride (DS) on roller skis with different grip functions and μ_s .

Between the incremental maximal tests, no difference was found in TTE, $\dot{V}O_{2\text{ PEAK}}$, HR_{PEAK} , B-HIa, RPE_{BREATH} , RPE_{ARM} and RPE_{LEG} using the RW_{REAR} , RW_{FORW} and Cam_{UNSTR} roller skis, while the tests using the $Cam_{0.2\mu s}$ roller skis resulted in a significantly shorter TTE ($\sim 30\%$), see Fig. 30, and this change occurred without changes in $\dot{V}O_{2\text{ PEAK}}$, HR_{PEAK} , B-HIa, RPE_{BREATH} , RPE_{ARM} and RPE_{LEG} (results not shown here). The correlation for TTE was significant between the tests using the Cam_{UNSTR} roller skis vs. the RW_{REAR} and RW_{FORW} , but not between the RW_{REAR} and RW_{FORW} , while the correlation of the $Cam_{0.2\mu s}$ vs. the RW_{REAR} , RW_{FORW} and Cam_{UNSTR} was poor, see Fig. 30.

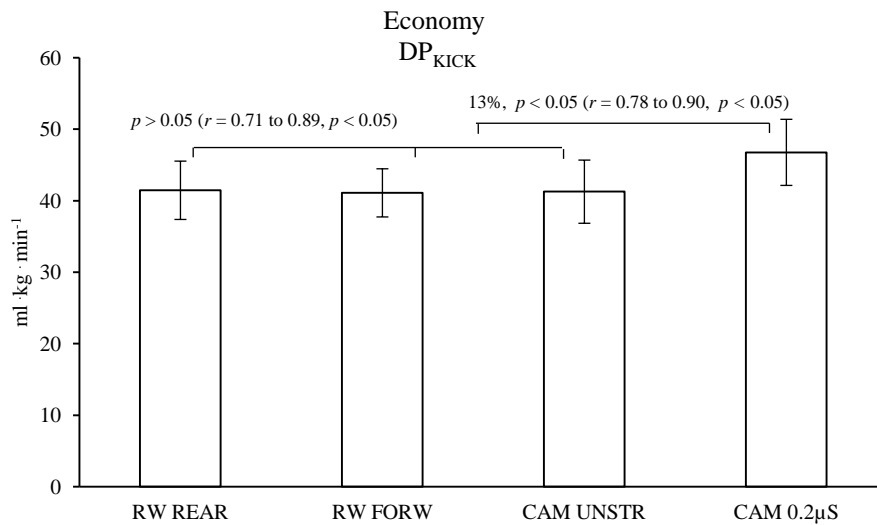

Fig. 29 Results of economy ($\dot{V}O_2$) when using kick double poling technique (DP_{KICK}) on roller skis with different grip functions and μ_s .

Thus, the results of this study showed that economy, HR and TTE are highly influenced by classical style roller skis with different μ_s , while no difference was found between tests using roller skis with similar μ_s . Also, the poor correlation for economy in DS and TTE showed that skiers with the best economy and performance time, respectively, with roller skis with a high μ_s , did not have the best economy and performance time when using roller skis with a μ_s more similar to on-snow skiing.

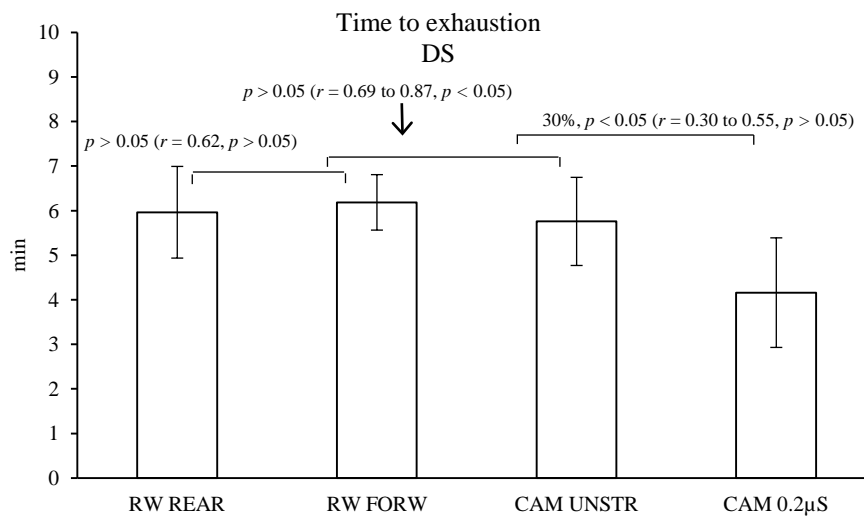

Fig. 30 Results of time to exhaustion (TTE) from incremental maximal tests using diagonal stride (DS) on roller skis with different grip functions and μ_s .

In study III, skiing economy and efficiency were calculated to be almost as decisive for performance time in cross-country skiing competitions as the $\dot{V}O_{2\text{ PEAK}}$ has shown to be for many years. Thus, considering that skiing economy and efficiency seem to be so important for the performance time of different skiers, and influenced by different μ_S , the question is raised whether the detection of a skier's economy and efficiency is valid when using roller skis with a μ_S several times higher than the μ_S of skiing on snow.

B-HIa was not influenced by different μ_S during the submaximal workloads. This is probably explained by relatively low exercise intensities for some of the subjects and the non-linear form of the B-HIa response curve, as discussed in study II.

Furthermore, CR, CL and RPE seem less influenced by μ_S (as for rolling resistance) and, considering the great differences in economy, they seem less accurate for evaluations of human performance in varying conditions in an exercise laboratory.

3.5.2 The influence of μ_S on leg forces

In the force measurements carried out on the RW_{REAR} and $\text{Cam}_{0,2\mu\text{S}}$ roller skis during submaximal skiing in DS and DP_{KICK} techniques, a significantly higher μ_S was used, and a higher $F_{X\text{ PEAK}}$ applied, by the skiers during the push-off phases when skiing with the RW_{REAR} roller skis. Furthermore, in DS, the $F_{X\text{ PEAK}}$ occurred later than the $F_{Z\text{ PEAK}}$ with the use of the RW_{REAR} roller skis, see Fig. 31, while other variables showed only a trend to higher values with the use of RW_{REAR} roller skis, mainly for $F_{X\text{ MEAN}}$, $F_{Z\text{ PEAK}}$, F_{tX} and F_{tZ} in DS.

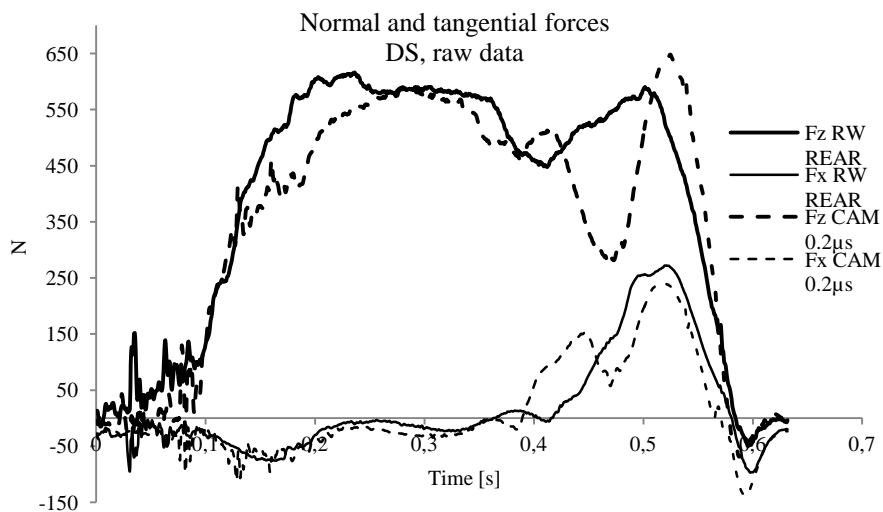

Fig. 31 The normal (F_Z) and tangential (F_X) forces measured on the RW_{REAR} and $\text{CAM}_{0,2\mu\text{S}}$ roller skis for one of the skiers during the leg push-off phase in the diagonal stride (DS) technique.

The μ_S used during skiing with the RW_{REAR} roller skis was about 3 to 4 times higher than what has been reported from on-snow skiing (Ekstrom 1981; Komi 1985; Komi & Norman 1987; Vahasoyrinki *et al.* 2008) and was likely due to the higher μ_S established in the fixture for the RW_{REAR} roller skis, see study IV. However, the μ_S established in the fixture for the RW_{REAR} roller skis was not entirely used in practical skiing.

During the push-off phase, the $CP_Z ROM$ started at a point in front of the heel and moved to a point in front of the ski boot, with a CP_{MEAN} close to the ski boot fix point. The reason why the CP_Z was able to move in front of the ski boot fix point was probably due to a rubber pad in the ski binding that is located vertically above the ski boot fix point. With increasing pressure from the ski boot on the rubber pad, such as during the latter part of the push-off phase, leverage will appear from the ski boot fix point and up to the rubber pad, creating torque and thus an increased F_Z on the ski in front of the ski boot.

The F_{TX} and the CR were not significantly different between the $Cam_{0.2\mu s}$ and RW_{REAR} roller skis. However, there was a trend to a 10 and 17 % lower F_{TX} in DP_{KICK} and DS respectively, when using the $Cam_{0.2\mu s}$ roller skis. If normalizing the force impulses, as regards the measured CR of the five skiers, into F_{TX} per second ($F_{TX} \cdot s^{-1}$), this results in an 8 % ($Cam_{0.2\mu s}$: $11.8 F_{TX} \cdot s^{-1}$, RW_{REAR} : $12.9 F_{TX} \cdot s^{-1}$) and 15 % ($Cam_{0.2\mu s}$: $17.4 F_{TX} \cdot s^{-1}$, RW_{REAR} : $20.2 F_{TX} \cdot s^{-1}$) difference in DP_{KICK} and DS, respectively, between the two types of roller skis used.

During skiing, the speed of the skier's centre of mass varies slightly around its mean (Komi *et al.* 1982), with an acceleration phase during the F_{TX} and a deceleration during the gliding phase (or rolling phase), when no propulsive force is applied on the ground surface by the skis and the ski poles. To maintain a certain average speed, the sum of $F_{TX} \cdot s^{-1}$ from the roller skis and the ski poles needs to be maintained. A reduction in $F_{TX} \cdot s^{-1}$ from the roller skis therefore needs to be compensated by an equally increased $F_{TX} \cdot s^{-1}$ from the ski poles. In this study, forces from the ski poles were not measured. However, the trend towards a lower F_{TX} and $F_{TX} \cdot s^{-1}$ using the $Cam_{0.2\mu s}$ roller skis is most likely to be a changeover of F_{TX} from the roller skis to the ski poles. This changeover, from less propulsive leg work to more upper body work, is most probably the reason for the poorer economy and shorter TTE found during skiing with the $Cam_{0.2\mu s}$ roller skis. However, it must be kept in mind that only five skiers participated in this part of the study.

Among the few studies that have presented results from 3D force measurements from skiing on snow, the majority presented very little detailed information. However, the more recently published paper by Vahasoyrinki *et al.* (2008) is an exception, with more detailed information from experiments during DS in an indoor ski tunnel on a 20 m long force plate system covered with snow.

In this study, the speed was slightly lower and the inclination higher than those of Vahasoyrinki *et al.* (2008). Furthermore, there was no drag force from any headwind acting on the skier during the treadmill experiments, while the dynamic friction coefficient during the gliding phases in the ski tunnel is unknown. However, even though the time of the

applied F_X in DS in this study was slightly shorter than that reported by Vahasoyrinki *et al.* (2008), the $F_{X\text{ MEAN}}$ was slightly higher, giving an comparable F_{t_X} , i.e. slightly lower for the $\text{Cam}_{0.2\mu\text{s}}$ and likewise higher for the RW_{REAR} roller skis (in Vahasoyrinki *et al.* (2008) ~14 Ns). Furthermore, calculations of the total F_{t_X} needed for elevating the skier against gravity and overcoming the roller skis' rolling resistance, leave a remaining F_{t_X} from the ski poles of ~38 to 39 Ns for the $\text{Cam}_{0.2\mu\text{s}}$ and RW_{REAR} roller skis, respectively, compared with the ~28 Ns found by Vahasoyrinki *et al.* (2008). Of note is that the two comparative studies had similar CRs.

The F_Z measured on the roller skis in this study was lower than in other studies that were carried out on snow, particularly the $F_{Z\text{ PEAK}}$ (Ekstrom 1981; Komi 1985; Komi & Norman 1987). Again, the paper by Vahasoyrinki *et al.* (2008) presented results in DS that were closer to the results of this study, with an $F_{Z\text{ MEAN}}$, at similar speeds, of about 0.8 of body mass. There was a trend towards a lower $F_{Z\text{ MEAN}}$ and $F_{Z\text{ PEAK}}$ for the $\text{Cam}_{0.2\mu\text{s}}$ roller skis in DS and the opposite in DP_{KICK} . This can be explained by the need for increased F_X from the ski poles, as described above. The ski poles' angle towards the surface changes during the push-off phase but, to some extent, there will always be an applied F_Z from the poles along with the F_X . During DS, the push-off phases from the roller skis and ski poles will be applied relatively simultaneously, while during DP_{KICK} the arms and ski poles will be in a forward swing phase during the leg push-off phase. Thus, the higher applied F_X from the ski poles in DS with the $\text{Cam}_{0.2\mu\text{s}}$ roller skis also implies a higher F_Z from the ski poles, which slightly counteracts the F_Z on the roller ski, while on the contrary the F_Z on the $\text{Cam}_{0.2\mu\text{s}}$ roller skis in DP_{KICK} can be increased due to the absence of lifting force from the ski poles during the push-off phase. This is partly the reason why the F_Z was lower than body weight.

The skiers chose different strategies for the applied F_Z , see Fig 31. From the curves, it can be seen that F_Z for a skier in DS more or less slowly decreased during the gliding and push-off phases with the use of the RW_{REAR} roller skis, while the F_Z with the use of the $\text{Cam}_{0.2\mu\text{s}}$ roller skis was highest at the same point of time as the $F_{X\text{ PEAK}}$ occurred. Furthermore, the preload phase with a rapid decrease in F_Z followed by a rapid increase up to the $F_{Z\text{ PEAK}}$ and $F_{X\text{ PEAK}}$, indicating a stretch-shortening cycle as described by Komi & Norman (1987), was not so evident for all skiers, especially not with the use of the RW_{REAR} roller skis. Furthermore, the $F_{X\text{ PEAK}}$ occurred later than the $F_{Z\text{ PEAK}}$ when skiing with the RW_{REAR} roller skis, as also can be seen in Fig. 31. This way of pushing off is named a "too late push-off", by cross-country ski coaches at a high level in Sweden, and is possible when roller skiing with ratcheted wheel roller skis due to the high μ_S .

3.6 Methodological considerations

The results of study I showed some differences in behaviour between the classical and freestyle roller skis. However, the overall findings were similar for both types of roller skis, despite the differences in their construction, i.e. the classical roller skis were equipped with rather wide rubber tyres, while the freestyle roller skis had thinner, thermoplastic polyurethane tyres. Even though there were similar results for the classical and freestyle roller skis despite their differences in construction, it cannot be established that the results in this study can be applied to all types of roller skis, since this study did not investigate the rolling resistance of roller skis from more than one manufacturer.

A source of uncertainty is the side forces on the wheels that occur when the roller skis are edged during G3 roller skiing. How these forces affect rolling resistance was not examined in the studies. Both differences in construction and the side forces will have some influence on the rolling resistance part of the power calculations. Furthermore, the situation for the G3 technique is especially complex as the roller skis are not rolling straight up the hill but at an angle to the forward direction. Also, the rolling resistance measurements were made on the treadmill surface using specific equipment and with a “static” normal force, in contrast to the more “dynamic” normal force acting on the wheels during human roller skiing. In the calculations it was assumed that a particular value of μ_R , established in the apparatus, likewise existed during human roller skiing.

The results of DS in study III were based upon measurements using ratcheted wheel rollers skis and it is not known how the high μ_S for these roller skis may have affected the comparison of economy and gross efficiency between the studied groups. The hypothesis is that skiers with less skiing experience could have been favoured and that the difference between recreational and elite skiers, and the ranges within groups, might be even larger on snow (and if using Camber-Ski roller skis with similar μ_S as for on-snow skiing) than was reported in this study.

The results of μ_S in study IV were based upon measurements of tangential and normal forces in a fixture. The measurements of the tangential forces were carried out while a static vertical load (static normal force) was applied on top of the roller skis. During human roller skiing both normal and tangential forces are applied dynamically and simultaneously. This disparity may have affected the results to some, but likely a minor, extent.

The part of study V which investigated forces applied on roller skis with different μ_S , during the leg push-off phases in DS and DP_{KICK}, were based upon participation of only five subjects. Many of the interesting trends for the causes in differences in economy and TTE could unfortunately not be statistically verified.

Strong support for the results of the experiments is provided by the validity and reliability study of the ergo-spirometry system, which showed very high accuracy for the $\dot{V}O_2$ and RQ measurements, and thereby also the calculations of the $P_{W\ INT}$ and efficiency.

3.7 Conclusions

In conclusion, this thesis has highlighted some key results from the experiments. They can be explained as follows:

Study I During a warm-up period of 30 minutes, freestyle and classical roller skis' μ_R significantly decreased to 60-75 % of its initial value. For another 30 minutes of rolling no significant change was found. Thus, the results from the warm-up study showed that a proper warm-up of the roller skis must proceed physiological testing, otherwise results cannot be accurately compared.

The study of the influence on μ_R of normal force, velocity and inclination showed that μ_R was strongly influenced by normal force, while the different velocities and inclinations of the treadmill had little influence on μ_R . Within a range of normal forces, $N_{TOTAL} = 213 - 604$ N, μ_R decreased almost 35-45 % for the tested classical and the freestyle roller skis. Also, the variation in μ_R between individual roller skis of the same model from the same manufacturer were of a magnitude up to 28 and 34 % for the tested freestyle and classical roller skis, respectively.

Study II The study of the effects of a ~50 % change in μ_R on physiological variables on submaximal steady rate exercises in most cases resulted in significant changes: P_W of 8-12 %, $\dot{V}O_2$ of 5-9 %, HR of 3-8 % and B-HIa 14-46 %, while there were mostly non-significant or small changes to CR, CL and RPE. The study showed a tendency for some of the variables to be more influenced by changes in μ_R during harder rather than lighter submaximal steady rate exercise. The incremental maximal tests showed that TTE was significantly changed by 12-24 % and this occurred without a significantly changed $P_{W MAX}$, $\dot{V}O_{2 MAX}$, HR_{MAX} and B-HIa, and that the influence on RPE was non-significant or small.

Study III This study, which investigated skiing economy and efficiency from the perspectives of performance ability, age and gender, showed that elite cross-country skiers have better skiing economy and higher gross efficiency during treadmill roller skiing than recreational skiers and that the senior elite have better economy and higher gross efficiency compared with their junior counterparts. However, no differences could be found between the genders. There are usually small differences in performance time between elite competitors but, in this study, large ranges in skiing economy and efficiency were observed for all the tested groups. Thus, the conclusion is that skiing economy and gross efficiency factors are almost as highly influential as $\dot{V}O_{2 PEAK}$ on the differences in

performance time in competitions between recreational, junior and senior cross-country skiers and between individual skiers within each category.

- Study IV The results in this study showed that ratcheted wheel roller skis, on a treadmill rubber mat and on dry and wet asphalt surfaces, reached values for μ_s that were five to eight times more than the values reported from on-snow skiing with grip-waxed cross-country skis. Thus, the results showed that grip during classical style roller skiing contrasts greatly with on-snow skiing on groomed trails, where proper technique is essential for good grip, i.e. where good grip is accordingly far less than for ratcheted wheel roller skis.
- Study V The study of the influence of classical style roller skis' μ_s on cross-country skiers performance showed that skiing economy, propulsive forces coming from the legs and TTE are highly changed for the worse when using roller skis with a lower μ_s , such as for on-snow skiing with grip waxed cross-country skis, in comparison to ratcheted wheel roller skis with a higher μ_s . Thus, a question is raised whether evaluations of economy, efficiency and time performance testing of cross-country skiers is valid when using ratcheted wheel roller skis, which have a much higher μ_s than cross-country skis for on-snow skiing. Furthermore, does training using roller skis with a high μ_s improve on-snow skiing technique and performance in DS and DP_{KICK} , or instead imply an adaptation towards a roller skiing technique which is not optimal for on-snow skiing?

4 ACKNOWLEDGEMENTS

I wish to express my gratitude to all those people who, in different ways, have made it possible for me to complete this thesis.

First of all to my main supervisor, Professor Peter Carlsson, my assistant supervisor, Associate Professor Marko Laaksonen, and co-author, Professor Mats Tinnsten (who in practise has worked as an assistant supervisor) for supporting me in everything; I have always received the help I have asked for. It is easy to be a PhD student when you have such strong support. Would also like to thank my mentor from my licentiate examination, Professor Per Tesch, who has shown a great deal of interest in my work and who has supported me whenever I needed it. Furthermore, thanks to all the hundreds of athletes who participated in the experiments and whose names I am unfortunately prevented from mentioning for ethical reasons.

To all the coaches who supported the athletes' participation in the experiments and for good co-operation in everything else. Thus, from the Swedish Ski Federation: Joakim Abrahamsson, Inge Bråten, Cathrine Engman, Erica Johansson, Magnus Ingesson, Sture Norén, Lars Selin, Bengt Stattin, Gunde Svan and Per-Åke Yttergård. From the US Biathlon Federation: Armin Auchentaller, Bernd Eiesenbichler, Mikael Löfgren, Ed Merrens and Per Nilsson. From the Ski University in Östersund: Mattias Persson, Per Svärdfelt, Tord Wiksten and Ulrika Öberg. From the Ski College in Järpen: Magnar Dalen, Kicki Fransson, Richard Grip and Jenny Hansson; in Sollefteå: Per-Ola Andersson, Tony Gustafsson, Jonas Johansson, Kari Korpela, Tobias Långberg and Bengt Stattin; in Ljusdal: Ulf Persson; in Lycksele: Ingela Kälvedal and Ove Vesterberg; in Sveg: Anna Engman and Jesper Johnsson; and from the Ski-Academy in Åsarna: Gustaf Berglund, Gunnar Hammarberg and Lena Håkansson.

Additional thanks go to coaches Bengt Stattin and Mattias Persson, mentioned above, and their athletes for their help with testing and evaluating the new type of classical designed roller ski used in study IV and V. Thanks also to the skiers Mats Larsson and Emil Jönsson, Swedish Ski Federation, for the same reason.

Furthermore, many special thanks are addressed to Master of Engineering, Sten Sandberg, Sidesystem, Oviken, for his excellence in manufacturing many of the specially designed equipment used in the studies. Also, to Jörgen Söderback, Dep. of Information Technology and Media, Mid Sweden University, for fruitful discussions on statistical issues.

Also, many thanks to the Swedish Winter Sports Research Centre (SWSRC) project manager, Bertil Karlsson, Jämtland Härjedalen Sports Association, and the assistant project manager, and project manager of the Ski University, Anders Edholm, who offered me employment at the SWSRC and the Ski University in Östersund. This position was the perfect starting point for future research in my field.

Thanks are also due to Professor Bengt Saltin, Copenhagen Muscle Research Centre, who supported me, and contributed to SWSRC and my personal development, during the

years when I was head of the laboratory (2004-2006). Bengt was also my sounding board as regards the setup of study II and the person who suggested that I add a group of recreational skiers to the groups of junior and senior elite skiers in study III.

Thanks are also due to my former colleague at SWSRC, Glenn Björklund, now a PhD, for help in always trying to find the most accurate equipment for testing elite athletes.

Thanks also to managing director Thomas Fuchs, A4 Campus, and his personnel for their great willingness to modifying the premises to fit the special needs of a treadmill roller skiing laboratory. Many thanks also to Ove Öberg, Rodby Innovation, and his personnel for their great talent in designing reliable custom-designed skiing treadmills.

Finally, thanks are also due to my co-researchers at SWSRC: Professor Hans-Christer Holmberg, Dep. of Health Sciences and Professor Jan Lisspers, Dep. of Social Sciences, Mid Sweden University, and Ph.D. Thomas Stöggl, Dep. of Sport Science and Kinesiology, University of Salzburg, Austria, and to all my former colleagues at the Swedish Ski Colleges, Winternet Luleå University of Technology, Jämtland Härjedalen Sports Association and to all my present colleagues at the Dep. of Engineering and Sustainable Development (additional thanks to the Sportstech group), Dep. of Health Sciences, Dep. of Information Technology and Media, and the personnel at the IT department and general services at Mid Sweden University, as well as to the European Union's regional development fund, which provided financial support for the studies in this thesis.

5 REFERENCES

- Allen DG, Lamb GD, Westerblad H. Skeletal muscle fatigue: Cellular mechanisms. *Physiol Rev* 2008; 88: 287-332.
- Aspenes ST, Nilsen TI, Skaug EA, Bertheussen GF, Ellingsen O, Vatten L, Wisloff U. Peak oxygen uptake and cardiovascular risk factors in 4631 healthy women and men. *Med Sci Sports Exerc* 2011; 43: 1465-1473.
- Bergh U. The influence of body-mass in cross-country skiing. *Med Sci Sports Exerc* 1987; 19: 324-331.
- Bergh U, Forsberg A. Influence of body-mass on cross-country ski racing performance. *Med Sci Sports Exerc* 1992; 24: 1033-1039.
- Bergh U, Forsberg A. Cross-country ski racing. In: Shephard RJ, Åstrand P-O, eds. *Endurance in sport*. 2 ed. London, United Kingdom: Blackwell science, 2000: 844-856.
- Bilodeau B, Roy B, Boulay MR. Effect of drafting on heart rate in cross-country skiing. *Med Sci Sports Exerc* 1994; 26: 637-641.
- Borg G. Borg's perceived exertion and pain scales. *Human Kinetics*. Champaign, 1998.
- Bourdon P. Blood lactate transitions thresholds: concepts and controversies. In: Gore CJ, ed. *Physiological tests for elite athletes*: Australian Sports Commission. Champaign, IL: Human Kinetics, 2000: 50-65.
- Carlsson P, Tinnsten M, Ainegren M. Numerical simulation of cross-country skiing. *Comput Methods Biomech Biomed Engin* 2011; 1: 1-6.
- Cavanagh PR, Kram R. The efficiency of human movement - a statement of the problem. *Med Sci Sports Exerc* 1985; 17: 304-308.
- de Boer RW, Vos E, Hutter W, de Groot G, van Ingen Schenau GJ. Physiological and biomechanical comparison of roller skating and speed skating on ice. *Eur J Appl Physiol Occup Physiol* 1987; 56: 562-569.
- di Prampero PE, Ferretti G. The energetics of anaerobic muscle metabolism: a reappraisal of older and recent concepts. *Respir Physiol* 1999; 118: 103-115.
- Ekstrom H. Force interplay in cross-country skiing. *Scandinavian Journal of Sports Sciences* 1981; 3: 69-76.
- Foxdal P. Prediction of maximal lactate steady state using incremental blood lactate accumulation tests. Uppsala, Sweden: Doctoral thesis, Uppsala University, 1994.
- Glaner MF, Silva RA. Validation of a new cycle ergometer. *Int J Sports Med* 2011; 32: 117-121.
- Guyton AC, Hall JE. *Textbook of medical physiology*. Pennsylvania, USA: Saunders, 2001: 162-174.
- Hamrock BJ, Schmid SJ, Jacobson BO. *Fundamentals in fluid film lubrication*. 2 ed: CRC Press, Series Dekker Mechanical Engineering, 2004.
- Hoffman MD, Clifford PS. Physiological responses to different cross-country skiing techniques on level terrain. *Med Sci Sports Exerc* 1990; 22: 841-848.
- Hoffman MD, Clifford PS, Bota B, Mandli M, Jones GM. Influence of body-mass on energy-cost of roller skiing. *Int J Sport Biomech* 1990a; 6: 374-385.
- Hoffman MD, Clifford PS, Foley PJ, Brice AG. Physiological responses to different roller skiing techniques. *Med Sci Sports Exerc* 1990b; 22: 391-396.
- Hoffman MD, Clifford PS, Snyder AC, O'Hagan KP, Mittelstadt SW, Roberts MM, Drummond HA, Gaskill SE. Physiological effects of technique and rolling resistance in uphill roller skiing. *Med Sci Sports Exerc* 1998; 30: 311-317.

- Hoffman MD, Clifford PS, Watts PB, Drobish KM, Gibbons TP, Newbury VS, Sulentic JE, Mittelstadt SW, Ohagan KP. Physiological comparison of uphill roller skiing - diagonal stride versus double pole. *Med Sci Sports Exerc* 1994; 26: 1284-1289.
- Hoffman MD, Clifford PS, Watts PB, O'Hagan KP, Mittelstadt SW. Delta efficiency of uphill roller skiing with the double pole and diagonal stride techniques. *Can J Appl Physiol* 1995; 20: 465-479.
- Hoffman MD, Jones GM, Bota B, Mandli M, Clifford PS. Inline skating - Physiological responses and comparison with roller skiing. *Int J Sports Med* 1992; 13: 137-144.
- Holmberg HC, Nilsson J. Reliability and validity of a new double poling ergometer for cross-country skiers. *J Sports Sci* 2008; 26: 171-179.
- Ingjer F. Maximal oxygen uptake as a predictor of performance ability in women and men elite cross-country skiers. *Scand J Med Sci Sports* 1991; 1: 25-30.
- Jensen K, Jørgensen S, Johansen L. A metabolic cart for measurement of oxygen uptake during human exercise using inspiratory flow rate. *European Journal of Applied Physiology* 2002; 87: 202-206.
- Jones AM, Grassi B, Christensen PM, Krustrup P, Bangsbo J, Poole DC. Slow component of VO₂ kinetics: mechanistic bases and practical applications. *Med Sci Sports Exerc* 2011; 43: 2046-2062.
- Komi PV. Ground reaction forces in cross-country skiing. In: Winter D, Norman R, Wells R, Hayes K, Patla A, eds. *Biomechanics IX-B*. Champaign: Human Kinetics, 1985: 185-190.
- Komi PV. Force measurements during cross-country skiing. *Int J Sport Biomech* 1987; 3: 370-381.
- Komi PV, Norman RW. Preloading of the thrust phase in cross-country skiing. *Int J Sports Med* 1987; 8: 48-54.
- Komi PV, Norman RW, & Caldwell G. Horizontal velocity changes of world class skiers using the diagonal technique. *Exercise and Sport Biology*. Champaign: Human Kinetics, 1982: 166-175.
- Kvamme B, Jakobsen B, Hetland S, Smith G. Ski skating technique and physiological responses across slopes and speeds. *European Journal of Applied Physiology* 2005; 95: 205-212.
- Larsson P, Henriksson-Larsen K. Combined metabolic gas analyser and dGPS analysis of performance in cross-country skiing. *J Sports Sci* 2005; 23: 861-870.
- Macdougall JD, Hughson R, Sutton JR, Moroz JR. Energy-cost of cross-country skiing among elite competitors. *Med Sci Sports Exerc* 1979; 11: 270-273.
- McArdle WD, Katch FI, Katch VL. *Exercise Physiology: Energy, nutrition, and human performance*. 5 ed. Philadelphia: Lippincott Williams & Wilkins 2001: 183, 202, 400-402, 1052, 1117-1120.
- Millet GY, Hoffman MD, Candau RB, Buckwalter JB, Clifford PS. Effect of rolling resistance on poling forces and metabolic demands of roller skiing. *Med Sci Sports Exerc* 1998; 30: 755-762.
- Mygind E, Andersen L, Rasmussen B. Blood lactate and respiratory variables in elite cross-country skiing at racing speeds. *Scand J Med Sci Sports* 1994; 4: 243-251.
- Niinimaa V, Dyon M, Shephard RJ. Performance and efficiency of intercollegiate cross-country skiers. *Med Sci Sports* 1978; 10: 91-93.
- Niinimaa V, Shephard RJ, Dyon M. Determinations of performance and mechanical efficiency in nordic skiing. *Br J Sports Med* 1979; 13: 62-65.

- Norman R, Ounpuu S, Fraser M, Mitchell R. Mechanical power output and estimated rates of nordic skiers during olympic competition. *Int J Sport Biomech* 1989; 5: 169-184.
- Norton K, Marfell-Jones M, Whittingham N, Kerr D, Carter L, Saddington K. Anthropometric assessment protocols. In: Gore CJ, ed. *Physiological tests for elite athletes: Australian Sports Commission*. Champaign, IL: Human Kinetics, 2000: 83-85.
- O'Donovan G, Blazeovich AJ, Boreham C, Cooper AR, Crank H, Ekelund U, Fox KR, Gately P, Giles-Corti B, Gill JM, Hamer M, McDermott I, Murphy M, Mutrie N, Reilly JJ, Saxton JM, Stamatakis E. The ABC of Physical Activity for Health: a consensus statement from the British Association of Sport and Exercise Sciences. *J Sports Sci* 2010; 28: 573-591.
- Padilla S, Mujika I, Orbananos J, Angulo F. Exercise intensity during competition time trials in professional road cycling. *Med Sci Sports Exerc* 2000; 32: 850-856.
- Pate RR, Pratt M, Blair SN, Haskell WL, Macera CA, Bouchard C, Buchner D, Ettinger W, Heath GW, King AC, et al. Physical activity and public health. A recommendation from the Centers for Disease Control and Prevention and the American College of Sports Medicine. *JAMA* 1995; 273: 402-407.
- Place N, Yamada T, Bruton JD, Westerblad H. Muscle fatigue: from observations in humans to underlying mechanisms studied in intact single muscle fibres. *Eur J Appl Physiol Occup Physiol* 2010; 110: 1-15.
- Roffey DM, Byrne NM, Hills AP. Effect of stage duration on physiological variables commonly used to determine maximum aerobic performance during cycle ergometry. *J Sports Sci* 2007; 25: 1325-1335.
- Rundell KW, Szmedra L. Energy cost of rifle carriage in biathlon skiing. *Med Sci Sports Exerc* 1998; 30: 570-576.
- Saltin B. The physiology of competitive c.c. skiing across a four decade perspective; with a note on training induced adaptations and role of training at medium altitude. In: Muller E, Schwameder H, Kornexl E, Raschner C, eds. *Science and skiing*. London: Chapman and Hall, 1997: 436-438, 452-454.
- Saltin B, Astrand PO. Maximal oxygen uptake in athletes. *J Appl Physiol* 1967; 23: 353-358.
- Sandbakk O, Holmberg HC, Leirdal S, Ettema G. Metabolic rate and gross efficiency at high work rates in world class and national level sprint skiers. *European journal of applied Physiology* 2010; 109: 473-481.
- Sandbakk O, Holmberg HC, Leirdal S, Ettema G. The physiology of world-class sprint skiers. *Scand J Med Sci Sports* 2011; 21: e9-e16.
- SKF. SKF Huvudkatalog 6000 SV. 2006: 49-85.
- Smith GA. Cross-country skiing: Technique, Equipment and Environmental factors affecting performance. In: Zatsiorsky V, ed. *Biomechanics in sport: Performance enhancement and injury prevention*. London: Blackwell Science Ltd, 2000: 247-270.
- Stoggl T, Muller E, Ainegren M, Holmberg HC. General strength and kinetics: fundamental to sprinting faster in cross country skiing? *Scand J Med Sci Sports* 2011; 21: 791-803.
- Vahasoyrinki P, Komi PV, Seppala S, Ishikawa M, Kolehmainen V, Salmi JA, Linnamo V. Effect of skiing speed on ski and pole forces in cross-country skiing. *Med Sci Sports Exerc* 2008; 40: 1111-1116.

- Welde B, Evertsen F, Von Heimburg E, Medbo JI. Energy cost of free technique and classical cross-country skiing at racing speeds. *Med Sci Sports Exerc* 2003; 35: 818-825.
- Withers R, Gore C, Gass G, Hahn A. Determination of Maximal Oxygen Consumption (VO₂max) or Maximal Aerobic Power. In: Gore CJ, ed. *Physiological tests for elite athletes*: Australian Sports Commission. Champaign, IL: Human Kinetics, 2000: 124.
- Zhang YY, Johnson MC, 2nd, Chow N, Wasserman K. Effect of exercise testing protocol on parameters of aerobic function. *Med Sci Sports Exerc* 1991; 23: 625-630.
- Åstrand P-O, Rodahl K. *Textbook of work physiology. Physiological bases of exercise*. McGraw-Hill Book Company, 1986: 190.