

**INTEGRATED ASSET MANAGEMENT FRAMEWORK: USING RISK-
BASED DECISION-SUPPORT SYSTEMS TO MANAGE ANCILLARY
HIGHWAY ASSETS**

A Dissertation
Presented to
The Academic Faculty

By

Richard S. Boadi

In Partial Fulfillment
of the Requirements for the Degree
Doctor of Philosophy in Civil Engineering in the
School of Civil and Environmental Engineering

Georgia Institute of Technology

May 2015

Copyright © Richard S. Boadi 2015

**INTEGRATED ASSET MANAGEMENT FRAMEWORK: USING RISK-
BASED DECISION-SUPPORT SYSTEMS TO MANAGE ANCILLARY
HIGHWAY ASSETS**

Approved by:

Dr. Adjo Amekudzi-Kennedy, Advisor
School of Civil & Environmental
Engineering
Georgia Institute of Technology

Dr. Michael O. Rodgers, Committee member
School of Civil & Environmental
Engineering
Georgia Institute of Technology

Dr. Yi-Chang James Tsai, Committee member
School of Civil & Environmental
Engineering
Georgia Institute of Technology

Dr. Samuel Labi, Committee member
School of Civil & Environmental
Engineering
Purdue University

Dr. Baabak Ashuri, Committee member
School of Building Construction
Georgia Institute of Technology

Dr. Michael Meyer, Committee member
Parsons Brinckerhoff

Date Approved: December 08, 2014

ACKNOWLEDGEMENTS

My utmost Thanksgiving goes to God Almighty, for his provision of my academic abilities and good health. I would like to express my sincere gratitude to my advisor, Dr. Adjo Amekudzi-Kennedy, whose encouragement, guidance, and support from the initial to the final level enabled me to develop an in-depth understanding of the study. Furthermore, I would like to thank my committee members, Dr. Michael Meyer, Dr. Samuel Labi, Dr. Michael Rodgers, Dr. James Tsai, and Dr. Ashuri Baabak, for their continuous enlightening contributions and critiques in shaping the final work. My sincere gratitude also goes to the entire faculty of Transportation Systems Engineering at the Georgia Institute of Technology for their support throughout my study. I would also want to acknowledge my research group members, the Infrastructure Research Group (IRG), for their open discussions in informing my work; especially, Janille Smith-Colin for being an extra editing eye, spending her whole weekend to review my draft.

Without the support of State Departments of transportation providing me with data for the analysis, this work wouldn't have seen any progress. For this reason, I would like to thank the Oregon State, Washington State, and New York State departments of transportation for supplying all the data I needed. In addition, I would like to thank my mother, sisters, and brother for their prayers and support during my studies. Lastly, but certainly not the least, to my three beautiful ladies in my life, my wife Hirut and daughters Ronia and Jozy, thank you for your encouragement, patience, understanding, and support during all the periods that I have been away.

TABLE OF CONTENTS

ACKNOWLEDGEMENTS	iii
LIST OF TABLES	xi
LIST OF FIGURES	xii
GLOSSARY OF TERMS	xv
GLOSSARY OF ABBREVIATIONS	xvi
SUMMARY	xix
Chapter 1 INTRODUCTION.....	1
1.1 Background of Transportation Asset Management.....	1
1.2 Research Motivation and Problem Description	6
1.3 Research Objectives	9
1.4 Research Methodology.....	10
1.5 Scope	12
1.6 Expected Results and Contributions	13
1.7 Dissertation Outline.....	14
Chapter 2 ANCILLARY HIGHWAY ASSETS AND RISK-BASED DECISION MAKING ...	16
2.1 Overview of Ancillary Highway Assets and Hazards.....	17
2.1.1 State of Practice of Ancillary Highway Asset and Hazard Management.....	19
2.1.2 Failure Modes of Ancillary Highway Assets	22

2.1.3 Examples of Notable Failures of Ancillary Highway Assets	23
2.1.4 The Importance of Managing Ancillary Highway Assets	30
2.2 Risk Management and Infrastructure Investment Decision Making.....	30
2.2.1 Overview of Risk-based Decision Making.....	31
2.3 Key Terminologies of Risk	32
2.3.1 Hazard.....	32
2.3.2 Vulnerability	33
2.3.3 Uncertainty	34
2.3.4 Probability of Occurrence.....	35
2.3.5 Event Consequence.....	35
2.3.6 Risks	36
2.3.7 Risk Appetite and Tolerance	39
2.4 Types of Risk Analysis Levels.....	43
2.5 Risk Assessment and Risk Management.....	45
2.6 Risk Management Plan.....	47
2.7 Risk Management Framework	49
2.8 Risk Quantification Methods	50
2.8.1 Expert Opinion	52
2.8.2 Risk Matrix.....	52
2.9 Evolution of Department of Homeland Security Risk Assessment	54

2.10 Application of Risk Management in Transportation Asset Management	56
2.11 Overview of Federal Authorization Risk-based Asset Management Requirement	61
2.12 Gap Analysis	61
Chapter 3 CORRIDOR-LEVEL ASSET-SYSTEMS MANAGEMENT.....	63
3.1 Hierarchy of Transportation System Planning	63
3.2 Reliable Transportation Network	66
3.3 Corridor-level Performance Assessment.....	68
3.4 System-of-Systems (SoS) Approach.....	71
3.5 Challenges in Implementing SoS Management	74
3.6 Spatial Analysis and Corridor-level or Integrated Asset Management.....	76
3.7 Selecting Alternatives	78
Chapter 4 CONCEPTUAL FRAMEWORK AND METHODOLOGY.....	80
4.1 Proposed Framework.....	80
4.1.1 Asset Category Priority Assessment.....	83
4.1.2 Corridor-level Risk Assessment and Prioritization	84
4.2 Proposed Method.....	86
4.2.1 Multi-criteria Decision Analysis	87
4.3 Criterion Weighting in Decision Analysis	89
4.4 Defining Decision Attributes	91
4.5 Scaling Decision Attributes or Criteria	92

4.5.1 The Exponential Value Function	94
4.5.2 Direct Attribute Scales.....	96
4.5.3 Surrogate Attributes.....	97
4.6 Formal Consensus Building Methods	98
4.6.1 The Delphi Method.....	99
4.6.2 Establishing a Panel of Experts	100
4.6.3 Application of the Delphi Method in the Transportation Sector	101
4.7 Problem Formulation.....	103
4.7.1 Hazard Exposure-vulnerability Index (HV_v)	105
4.7.2 Corridor Criticality Index	108
4.7.3 Corridor Risk Score Estimate	109
4.8 Sensitivity Analysis.....	110
4.9 Model Assumptions.....	112
Chapter 5 FRAMEWORK APPLICATION AND DISCUSSION OF CASE STUDY RESULTS	
.....	113
5.1 Framework Application.....	113
5.1.1 Applying Phase One: Asset Category Priority Assessment	113
5.1.2 Selection of Case Study DOTs and Data Acquisition	114
5.1.3 Data Limitations	115
5.1.4 Available Data Systems.....	116

5.1.5 Data Extent and Asset Vulnerability Assessment	118
5.1.6 Applying Phase Two: Corridor-level Risk Assessment and Prioritization	129
5.2 Discussion of Case Study Results	135
5.2.1 Minnesota Department of Transportation.....	136
5.2.2 New York State Department of Transportation.....	142
5.2.3 Oregon Department of Transportation	150
5.2.3 Sensitivity Analysis	154
5.2.4 Policy Implication.....	156
 Chapter 6 CONCLUSIONS, RECOMMENDATIONS, CONTRIBUTIONS, AND FUTURE	
WORK	159
6.1 Conclusions	159
6.1.1 Summary.....	159
6.1.2 Implementing the HARM-DSS	161
6.1.3 Considering the Synergies between Systems and Silo Analysis	162
6.1.4 Assessing Asset Vulnerability	163
6.1.5 Scaling Attributes Preference	164
6.1.2 Selecting a Risk Characterization Method	165
6.2 Recommendations	166
6.2.1 Data Needs.....	166
6.2.2 Target Setting	167

6.2.3 Federal Commitments.....	168
6.2.4 Performance Assessment.....	168
6.3 Research Contributions	169
6.4 Future Research.....	171
APPENDIX A Examples of Ancillary Assets and Highway Hazards.....	173
APPENDIX B LOCATIONS OF UNSTABLE AND MITIGATED SLOPES ALONG WASHINGTON STATE ROUTES	176
APPENDIX C EXAMPLES OF INTERNATIONAL AND AGENCY STANDARD RISK FRAMEWORK.....	177
APPENDIX D TYPICAL COMPONENTS OF A CULVERT FOR PERFORMANCE ANALYSIS.....	181
APPENDIX E.1 MnDOT CORRIDOR VULNERABILITY TO PLATEBEAM BARRIER FAILURE.....	182
APPENDIX E.2 MnDOT CORRIDOR VULNERABILITY TO OVERHEAD SIGN STRUCTURES FAILURE.....	183
APPENDIX E.3 MnDOT CORRIDOR VULNERABILITY TO CULVERTS FAILURE.....	184
APPENDIX F.1 NYSDOT CULVERT VULNERABILITY AND RELATIVE LOCATIONS	185
APPENDIX F.2 NYSDOT CORRIDOR VULNERABILITY TO CULVERTS FAILURE	186
APPENDIX F.3 NYSDOT CORRIDOR VULNERABILITY TO GUARDRAILS FAILURE	187
APPENDIX G.1 ODOT CORRIDOR VULNERABILITY TO UNSTABLE SLOPE FAULURE	188

APPENDIX G.2 ODOT CORRIDOR VULNERABILITY TO CULVERTS FAILURE 189

REFERENCES 191

LIST OF TABLES

Table 2.1 Examples of Culvert Failures and Consequences in the United States	29
Table 2.2 DHS Categorization of Risk	45
Table 2.3 MAP-21 Gaps and Research Remedies	62
Table 4.1 von-Neumann-Morgenstern Utility Scale.....	97
Table 5.1 Data Availability and Extent.....	118
Table 5.2 Culvert Condition Rating Codes and Vulnerability Ratings	120
Table 5.3 Plate-beam Barrier Condition Assessment	121
Table 5.4 Plate-beam Barrier Vulnerability Assignment.....	121
Table 5.5 Overhead-Sign Structure Vulnerability Assignment	121
Table 5.6 NYSDOT Culvert Components Numerical Rating Scale.....	124
Table 5.7 NYSDOT Culvert General Recommendation Rating Scale	125
Table 5.8 NYSDOT Culvert Vulnerability Assessment.....	126
Table 5.9 Example of Rated Cable Guardrail.....	128
Table 5.10 Corridor Criticality Criteria and Weights	131
Table 5.11 Annual Average Daily Traffic and Truck Traffic Criticality Scale.....	132
Table 5.12 Detour and Traffic Growth Criticality Scales.....	132
Table 5.13 Road Functional Class Criticality Scales.....	132
Table 5.14 Corridor Vulnerability Scales: Assets with Installation Year.....	134
Table 5.15 Corridor Vulnerability Scales: Assets with Condition Information	134
Table 5.16 Sensitivity Analysis: Different Corridor Alternatives	156

LIST OF FIGURES

Figure 1.1 Overview of an Asset Management Framework	3
Figure 1.2 Transportation Asset Management: Resource Allocation and Utilization	4
Figure 1.3 Research Methodology	11
Figure 2.1 Culvert failure on Interstate-88 in New York.....	25
Figure 2.2 Failed ERS along Riverside Drive near Manhattan in New York.....	26
Figure 2.3 A Failed Cantilever Overhead-Sign Structure.....	26
Figure 2.4 Underperforming Guardrails	27
Figure 2.5 Example of a Failing Road Sign.....	27
Figure 2.6 Rockfall in Glenwood Canyon, Colorado	28
Figure 2.7 Debris Flow of Landslide Shuts Down Roadway	28
Figure 2.8 Classification of Risks and Threats	38
Figure 2.9 Performance over Time Uncertainty	41
Figure 2.10 Performance Measure with Uncertainty	41
Figure 2.11 Agency Risk Universe Level.....	42
Figure 2.12 Agency Risk Tolerance Level	42
Figure 2.13 Agency Risk Appetite Level	43
Figure 2.14 Typical Risk Management Framework	50
Figure 2.15 A Two-dimensional Risk Matrix.....	54
Figure 2.16 A Multi-dimensional Risk Matrix	54
Figure 2.17 Timeline of DHS Risk Assessment Methodologies	56
Figure 3.1 Transportation Systems Planning Hierarchy	65
Figure 3.2 Corridor-level Performance Assessment Hierarchy	69

Figure 3.3 System-of-systems Tool for Transportation Infrastructure Management Systems	72
Figure 4.1 HARM-DSS Framework	82
Figure 4.2 Families of Monotonically Increasing Exponential Value Functions	95
Figure 4.3 Families of Monotonically Decreasing Exponential Value Functions	96
Figure 4.4 Definition of Risk Elements and their Main Attributes	105
Figure 5.1 MnDOT Distribution of Corridor Risk Elements	136
Figure 5.2 MnDOT Asset Category Vulnerability Performance	138
Figure 5.3 MnDOT Corridor Vulnerability Based on Asset Category	139
Figure 5.4 MnDOT Corridor Risk Elements	140
Figure 5.5 MnDOT Corridor Exposure-Vulnerability Index	140
Figure 5.6 MnDOT Corridor Criticality Index	141
Figure 5.7 MnDOT Corridor Overall Risk Index	141
Figure 5.8 NYSDOT Distribution of Corridor Risk Elements	142
Figure 5.9 NYSDOT Asset Category Vulnerability Performance	144
Figure 5.10 NYSDOT Corridor Vulnerability Based on Asset Category	146
Figure 5.11 NYSDOT Corridor Risk Elements	147
Figure 5.12 NYSDOT Corridor Exposure-Vulnerability Distribution	148
Figure 5.13 Section of NYSDOT Region 5 Corridor Exposure-Vulnerability Index	148
Figure 5.14 Section of NYSDOT Region 5 Corridor Criticality Index	149
Figure 5.15 Section of NYSDOT Region 5 Corridor Risk Index	149
Figure 5.16 ODOT Distribution of Corridor Risk Elements	150
Figure 5.17 ODOT Corridor Vulnerability Based on Asset Category	151
Figure 5.18 ODOT Corridor Risk Elements	151

Figure 5.19 ODOT Corridor Exposure-Vulnerability Distribution 152

Figure 5.20 ODOT Corridor Exposure-Vulnerability Index Heat Map 153

Figure 5.21 ODOT Risk Score Heat Map..... 153

Figure 5.22 Sensitivity Analysis: Asset Class Vulnerability Influence on Overall Corridor
Exposure-Vulnerability..... 155

GLOSSARY OF TERMS

Condition data	Data describing the physical conditions and state of an infrastructure.
Consequence	A result or effect of an action or inaction.
Criteria	A standard of judgment, or principle for evaluating or testing something.
Critical assets	Assets or infrastructure whose failure would cause considerable system impact or severe loss (financial, integrity, trust, etc.) to a transportation agency.
Criticality	Relative importance of a corridor or an asset within a pool of other alternatives.
Decision maker	Person or organizational unit who defines directions in relation to achieving system or organizational objectives and goals.
Exposure	Number of system users who would potentially be exposed to an impending threat or hazard.
Hazard	A pending condition or physical situation that can potentially result in an unwanted outcome, such as road closures or delays.
Risk	The effect of uncertainty on expected outcomes (IIMM, 2011). Measured as a combination of the probability of an uncertain event and its consequences.
Risk elements	Variables used to characterize a risk event.
Surrogate	Something that serves as a substitute for another measure under specific conditions.
Threat	A situation likely to cause harm to a transportation system or organization.
Uncertainty	Randomness in events that cannot be predicted by statistical probability (Lofstedt and Boholm, 2009)
Vulnerability	A measure of a system's susceptibility to incidence occurrence—failure.

GLOSSARY OF ABBREVIATIONS

AADT	Average Annual Daily Traffic
AASHTO	American Association of State and Highway Transportation Officials
ADT	Average Daily Traffic
AHA	Ancillary Highway Asset
ATC	Australian Transport Council
CJCSM	Chairman of the Joint Chief of Staff Manual
CSAH	County State-Aid Highways
DA	Decision Analysis
DHS	Department of Homeland Security
DOT	Department of Transportation
DSS	Decision-support System
EPA	Environmental Protection Agency
ERS	Earth Retaining Structure
FEMA	Federal Emergency Management Agency
FHWA	Federal Highway Administration
GIS	Geographic Information System
GRAMS	Guiderail Asset Management System

HARM	Highway Assets Risk Management
HPMS	Highway Performance Management System
ICM	Integrated Corridor Management
IIMM	International Infrastructure Management Manual
ISM	Integrated System Management
ISO	International Organization for Standards
LOS	Level of Service
MAP-21	Moving Ahead for Progress in the 21 st Century
MCDA	Multi-criteria Decision Analysis
MnDOT	Minnesota Department of Transportation
NBI	National Bridge Inventory
NCHRP	National Cooperative Highway Research Program
NHPP	National Highway Performance Program
NHS	National Highway System
NYSDOT	New York State Department of Transportation
OAM	Office of Asset Management
ODOT	Oregon Department of Transportation

PBP	Performance-Based Planning
TAM	Transportation Asset Management
TAMS	Transportation Asset Management System
TTP	Truck Traffic Percentage
SAW	Simple Additive Weighting
SoS	System-of-systems
SR	Sensitivity Ratio
USDHS	United States Department of Homeland Security
USDOT	United State Department of Transportation
USMS	Unstable Slope Management System
WSDOT	Washington State Department of Transportation

SUMMARY

Risk assessment is an essential part of an effective transportation asset management program. The 2012 surface transportation bill, Moving Ahead for Progress in the 21st Century, requires state departments of transportation (DOTs) to establish risk- and performance-based asset management programs for the National Highway System. While the bill's provisions include requirements only for pavement and bridge assets, they also recommend that DOTs consider other ancillary highway assets such as culverts and earth retaining structures, and hazards such as rockfalls and landslides. This research introduces an integrated risk framework with supporting algorithms to provide for the integration of ancillary assets and hazards into existing transportation asset management systems, and facilitate budget planning and resource allocation. The framework, Highway Assets Risk Management Decision-Support System (HARM-DSS), adopts a system-of systems perspective in defining and evaluating performance, and analyzing and addressing risk. The algorithms are developed using multi-criteria decision analysis (MCDA) and risk analysis methods; value functions are applied to scale performance attributes, and additive weighting to integrate multiple risk criteria. The methodology is applied at the corridor-level to analyze three different case studies using data with notable variability from New York, Minnesota and Oregon. The cases demonstrate the process for developing descriptive and visual information on multi-asset/hazard corridors, with sparse to medium data, in order to identify corridors that are vulnerable to failure, as well as exhibit high risk of failure within a transportation network. The results demonstrate that HARM-DSS can be applied across competing corridors or alternatives to produce descriptive and intuitive results that decision makers can use in budget planning and resource allocation. This research extends the risk-based thinking on transportation asset management, by moving it from a silo-ed to an integrated

analytical platform that considers multiple non-homogenous assets and hazards simultaneously. It identifies data deficiencies and offers recommendations on the requisite data collection on asset inventory and condition to improve objectivity in the analytical process and confidence in the analysis results. In addition, it offers recommendations on the appropriate use of expert knowledge in supplementing existing data deficiencies in the interim. This work is potentially useful to decision makers involved in distributing resources to preserve the reliability and resiliency of transportation systems, as well as meet the existing performance- and risk-based Federal mandates for transportation asset management.

Chapter 1 INTRODUCTION

1.1 Background of Transportation Asset Management

Over the past several decades, owners of infrastructure assets (and liabilities), such as transportation agencies, have applied Transportation Asset Management (TAM) principles as a decision-support tool for transportation planning and investment decision making over the lifecycles of infrastructure facilities and systems (Cambridge Systematics et al., 2002, AASHTO, January 2011). Broadly, asset management can occur at all levels of an organization. Generally, a transportation agency's assets include the physical transportation infrastructure (e.g., pavements, bridges, culverts, and all other roadway appurtenances) and other resources that add value to the agency (e.g., human resources, data, etc.). The definition of asset management has evolved throughout the years. However, the core purpose of a formalized and structured approach to maintaining and preserving our transportation infrastructure remains.

The AASHTO Transportation Asset Management Guide Volume 1 defines TAM as “a strategic and systematic process of operating, maintaining, upgrading, and expanding physical assets effectively throughout their lifecycle” (Cambridge Systematics et al., 2002). The 2012 surface transportation bill—Moving Ahead for Progress in the 21st century (MAP-21)—defines TAM as “a strategic and systematic process of operating, maintaining, and improving physical assets, with a focus on engineering and economic analysis based upon quality information, to identify a structured sequence of maintenance, preservation, repair, rehabilitation, and replacement actions that will achieve and sustain a desired state of good repair over the lifecycle of the assets at minimum practicable cost” (FHWA, 2012).

The AASHTO definition of TAM focuses on a Department of Transportation's (DOT) business process for resource allocation and utilization with the objective of better decision making based upon quality information and well-defined objectives (Cambridge Systematics et al., 2002). In the same way, MAP-21 bridges the concepts of performance, risk, and asset management in making informed decisions. Asset management, in addition to being applied as a system-based decision-support tool, is also identified as a way of doing business through the incorporation of the key functions of a transportation agency, including planning, engineering, finance, programming, construction, maintenance, and information systems (Cambridge Systematics et al., 2002). Accordingly, asset managers employ asset management principles to minimize the total cost of designing, acquiring, operating, maintaining, replacing, and disposing capital transportation assets over their useful lives while maintaining desirable performance targets. The main impetuses of the development of formal asset management programs are the need to meet legislative mandates, demand for increased financial accountability for publicly-owned assets, aging infrastructure, and a growing need for better allocation and utilization of limited or declining resources.

Figure 1.1 presents the FHWA overview of transportation asset management as outlined in the *Asset Management Primer* report. Another framework, Figure 1.2, is adopted from Volume 1 of the AASHTO Transportation Asset Management Guide. The frameworks illustrate resource allocation and utilization processes in asset management. The flexibility of the framework presented in Figure 1.2 allows for modifications to meet the needs of organizations with dissimilar policy, institutional, organizational, technological, and financial settings (Cambridge Systematics et al., 2002).

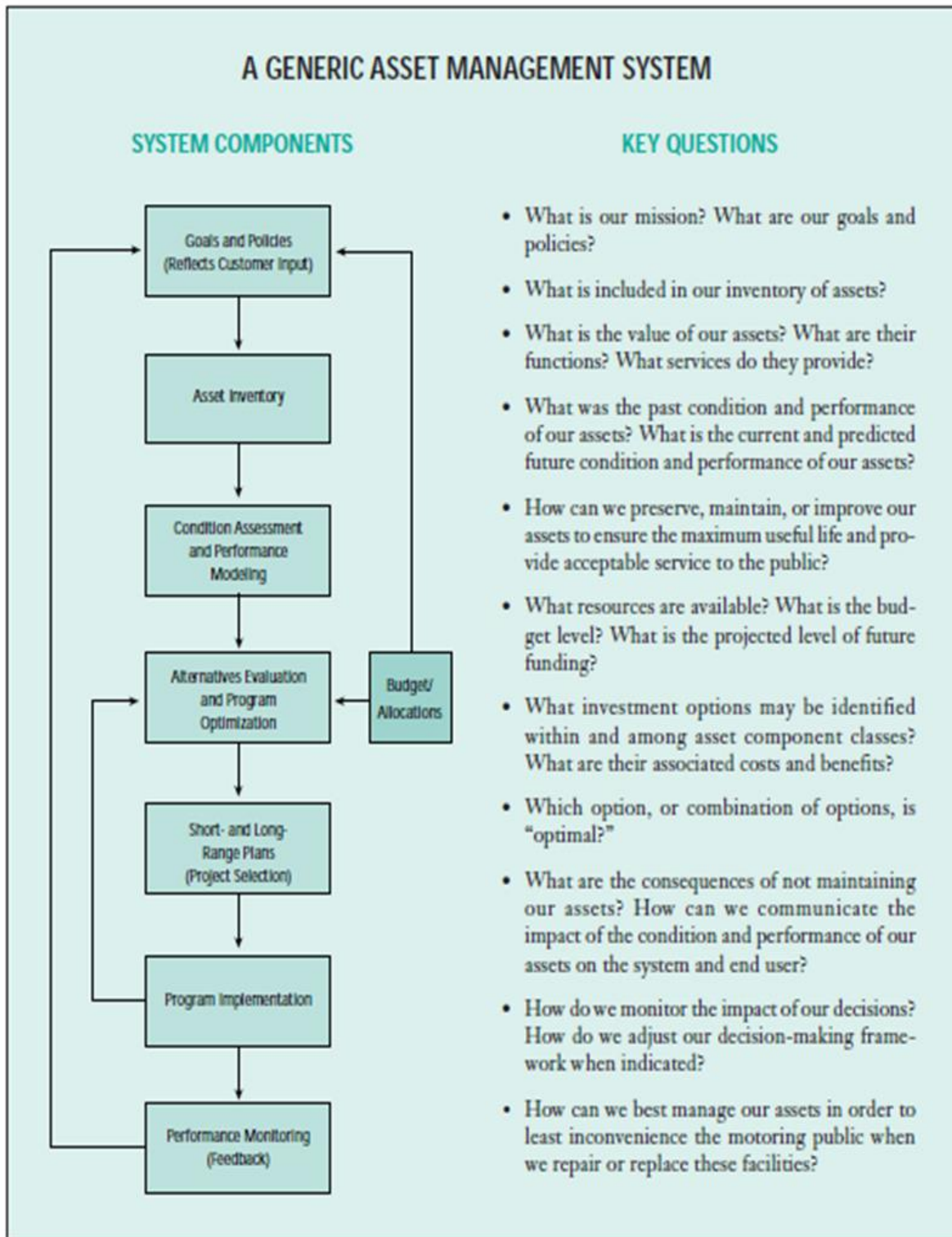

**Figure 1.1 Overview of an Asset Management Framework
(OAM/FHWA/USDOT, 1999)**

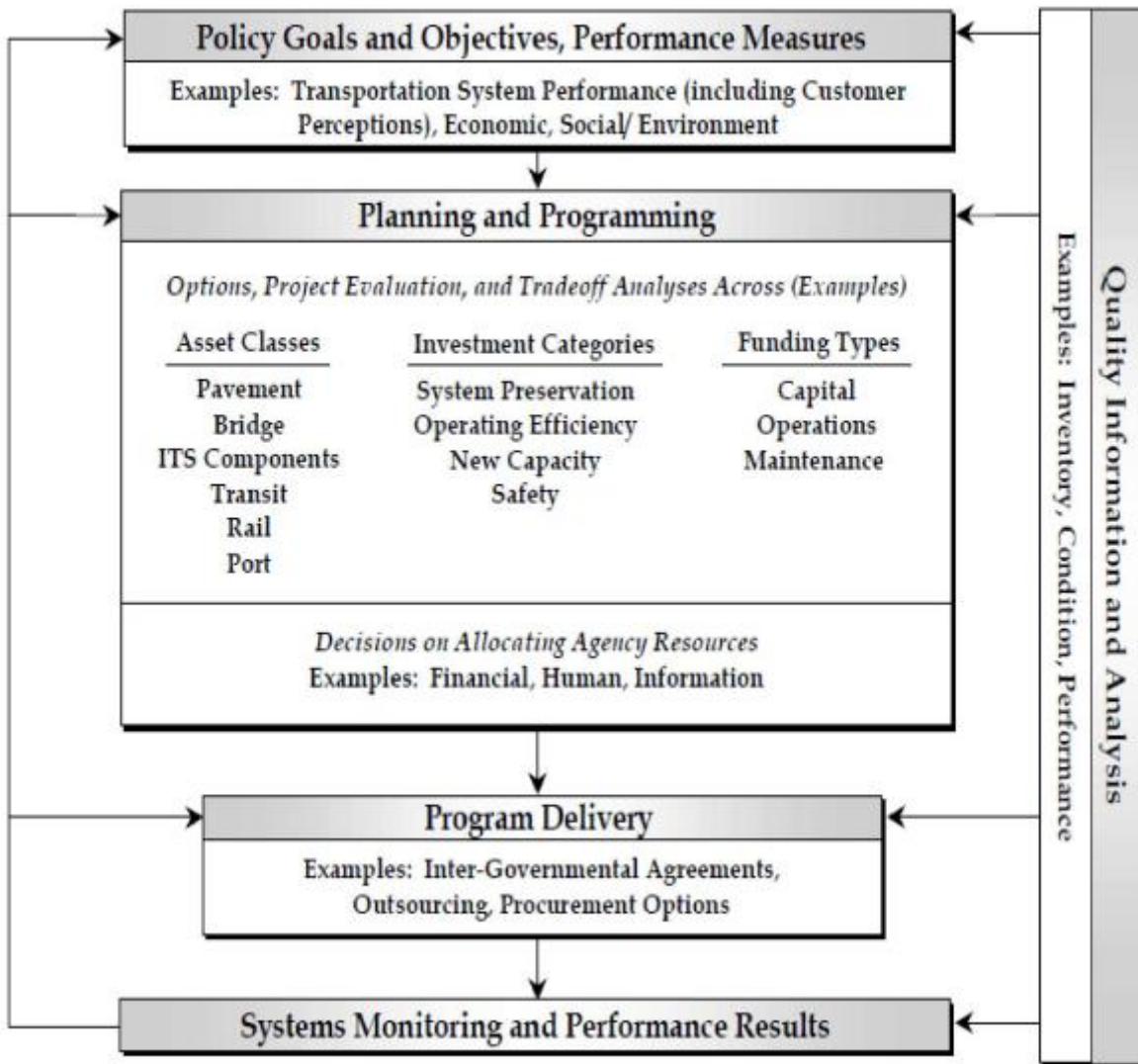

Figure 1.2 Transportation Asset Management: Resource Allocation and Utilization (Cambridge Systematics et al., 2002)

Increasingly, the effects of aging infrastructure, increasing maintenance and replacement costs, and limited or declining funds motivate transportation agencies and decision makers to seek more proactive and efficient ways to manage their assets and potential hazards (threats). Asset management, therefore, presents an opportunity that facilitates an agency’s decisions in resource allocation and utilization in managing its transportation infrastructure (Cambridge Systematics et al., 2002). Indeed, asset management tools allow an agency to base its decision

methods and criteria on current policy guidelines. In addition, asset management tools enable asset managers to consider a range of alternatives while they focus on the outcomes of decisions and apply more objective and consistent information to decisions.

In 2005, United States transportation professionals performed an international review of asset management practices in Australia, New Zealand, and the United Kingdom, and they identified several asset management tools that these countries have successfully applied in their decision processes (Geiger et al., 2005). At a time of declining or limited resources, these system-based management practices can help agencies make informed-decisions and also provide the general public with a convenient, safe, and reliable transportation network. Traditionally, in the United States, the practice of TAM has mainly involved “larger” transportation assets, or infrastructure, such as pavements and bridges. This trend is gradually evolving as various agencies have started data gathering on their other assets (Hawkins & Smadi, 2013). Even so, historical trends have seen rapid developments of maturing systems for the management of pavements and bridges. Currently, many DOTs have in place a pavement or a bridge management system, with different maturity levels (Markow & Hyman, 2009, FHWA, 2011). To some extent, one can attribute this development to the existence of formal Federal, state, or local mandates that essentially require DOTs to develop, implement, and maintain these management systems. The literature reveals many success stories through the use of asset management systems in decision making (EPA et al., 2009; FHWA, 2005).

An effective asset management system entails three main principles: strategic, analysis, and decision making (Cambridge Systematics et al., 2002). Asset management is strategic because it focuses on asset performance and cost while aligning with the policy goals and objectives of an agency. This principle merges the other two principles of asset management;

analysis and decision making. Aligning with these principles and making sound business decisions that benefit the taxpayer and accomplish organizational goals require complete, current, and quality information on transportation infrastructure. In addition, asset managers can employ strong analytical capabilities while making use of suitable and practical information collection and storage capabilities. Finally, as a business process, asset management involves tradeoff analyses across competing and conflicting alternatives together with organizational goals, policies, budget, and asset performance. Thus, through the application of available data and the elicitation of expert knowledge and engineering judgment, all levels of the organization contribute to effective communication that addresses the needs of asset management.

Furthermore, with this information in hand, decision makers can allocate and utilize their resources effectively and efficiently, while monitoring and evaluating system performance. Consequently, decision makers can make adjustments or changes with the aim of attaining set performance targets and achieving organizational goals. These processes facilitate an effective asset management program that enables transportation agencies to plan, build, operate, preserve, and improve the performance of their facilities more cost-effectively. These actions enable decision makers to make the best use of limited resources, enhance agency credibility and accountability, meet legislative mandates and requirements, and contribute to the long-term economic vitality of communities.

1.2 Research Motivation and Problem Description

The literature reveals that TAM has evolved over the past two decades. Indeed, transportation agencies and asset managers have successfully developed systems for managing their pavement and bridge assets. Admittedly, many of these activities have been facilitated by Federal, state, or local mandates or requirements. However, since identical mandates do not exist for other

categories of assets, such as culverts, and hazards, such as rockfalls, the management of these assets is usually left to the discretion of a transportation agency. Basically, decision makers face the challenge of identifying which asset categories must be prioritized and incorporated into their asset management system, where there are limited budgets.

International transportation agencies have explored the application of risk management in TAM. In the United States, with the passage of MAP-21, risk management continues to gain much recognition in TAM. Similarly, other industries in the United States, such as the financial and the insurance industries, and transportation agencies in other countries have made considerable progress in applying risk management principles to improve their business practices. As such, U.S. transportation decision makers can capitalize on the opportunities MAP-21 offers as well as documented experiences and benefits to integrate risk decision-support tools into their existing TAM plans. In addition, decision makers can augment risk principles with existing TAM systems to collectively and effectively manage critical assets or potential hazards that threaten the successful operation of the transportation system and their agencies. In resource allocation and utilization decision making, these asset categories or hazards compete for the same limited funding or resources; therefore, decision makers require systematic and replicable approaches that fit within the existing context of their asset management programs to make informed decisions that address organizational goals.

While risk management is widely practiced by financial and other profit-oriented organizations in United States and around the world, the public sector, particularly the transportation asset management sector, has not fully utilized risk principles at the strategic, operational-, or programming-level of decision making. Although some decision makers assert to incorporate risk principles implicitly in their programming and operation processes, their

claims remain unsubstantiated and unknown because of the lack of documentation to characterize their practices. In transportation network operations, stakeholders (including system users) want structurally-sufficient bridges and smooth pavement ride. Primarily, asset managers and decision makers have a keen need to offer taxpayers quality system standards and also eliminate performance variability. As such, one cannot discuss a reliable transportation system without an understanding, analysis, and treatment of system uncertainties and risks associated with the presence of ancillary highway assets and potential hazards. This research seeks to address these issues and bridge existing gaps.

Precisely, the following observations motivate this dissertation research:

- Aging transportation infrastructure: A majority of the transportation infrastructure has reached or is approaching its useful service life. Accordingly, decision makers and asset managers need better proactive strategies that address risk in an integrated manner.
- Increasing rate of ancillary highway asset failure: Transportation agencies continue to experience asset failures that interrupt network reliability. Although many of these failures receive public or media attention, some have gone unnoticed because of their relative impact (i.e., lack of injuries and fatalities). In particular, performance failures that are non-catastrophic tend not to receive as much public or media attention relative to catastrophic failures.
- Demands of legislative mandates: MAP-21 requires all DOTs to establish a risk-based asset management framework for the National Highway System (NHS), and a comprehensive asset management plan cannot emerge without looking beyond the preservation of pavements and bridges.

- Potential benefits risk management offers: As demonstrated by some private and international organizations, risk management as a decision support tool can similarly help US transportation organizations (i.e., Federal, State, and Local DOTs) to utilize their limited resources more effectively.

Overall, these observations give rise to the following research questions:

1. What is the extent of adoption of risk and asset management principles in making investment decisions regarding ancillary highway assets in the context of the overall transportation system?
2. What decision-support tools (framework and analytical models) do decision makers and analysts use in supporting their risk programs?
3. What are the potential benefits in integrating ancillary highway assets within existing asset management systems to conduct corridor-level analysis, and how can this be done?

1.3 Research Objectives

To answer these research questions and help agencies and asset managers integrate ancillary assets and hazards into their existing asset management frameworks for formal management, this research proposes to achieve the following objectives:

- Develop an integrated risk framework to help agencies phase in critical ancillary highway assets and potential hazards into existing management systems
- Develop a risk decision-support system to help agencies implement the risk framework within the context of their organization:
 - Assess the risk-level of each asset category with respect to the agency's strategic goals to identify higher-risk asset categories for inclusion in program development

- Assess the relative risk of individual assets within a given asset category taking into consideration the age and useful life of the asset (i.e., vulnerability to failure) and road characteristics (i.e., criticality) along which the asset is located
- Assess the relative risk of each corridor within a given network by integrating results from the previous two models
- Offer recommendations/guidelines that will enable practitioners exploit the full potential of this proposed method

1.4 Research Methodology

To accomplish these objectives, this dissertation adopts a multi-stage approach. Figure 1.3 illustrates the sequence of the three stages with which the dissertation proceeds. In fact, it is important to acknowledge that the approach is not necessarily linear since some latter work can prompt further review of the initial steps. As such, the methodology is best classified as an iterative process. Narratively, the stages include:

1. Defining the scope of the study and subsequently reviewing relevant literature
2. Developing a conceptual framework with complementary decision-support system for practical application
3. Implementing case study analyses

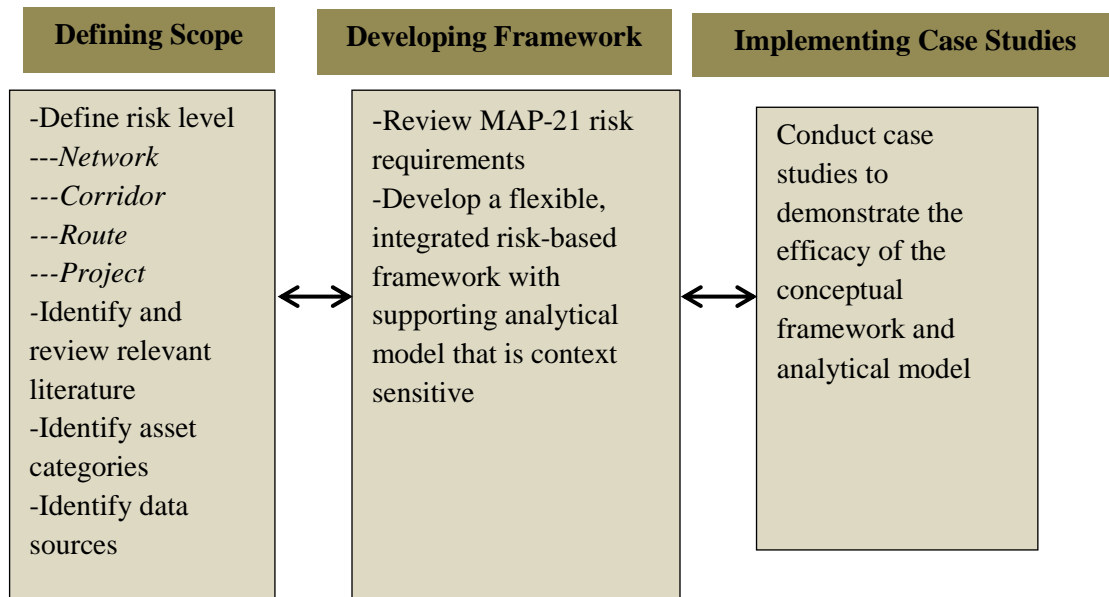

Figure 1.3 Research Methodology

The first task involves scoping and defining the context of the study and, subsequently, reviewing relevant literature. The context definition basically involves establishing the risk level the framework will be targeting and the type of infrastructure or asset categories or hazards that will be covered in the study. As part of the literature review, the research looks at the state of practice of managing ancillary assets, and identifies states with best practices to incorporate these states in the case studies. The research also reviewed how decision makers use risk management principles to influence decision making. Since transportation decision makers have not used risk principles extensively in program-risk management, this task reviewed the five-series of risk reports released by the FHWA Office of Asset Management to develop some guiding principles.

The second task involves identifying and reviewing different types of risk frameworks, different risk characterization methods or some risk modeling techniques that risk analysts and managers use in assessing risk. Risk characterization or modeling is one of the most important steps in risk management. As such, it is imperative that the research identifies the most applicable framework and plausible modeling techniques in assessing risks, in this research

context. If risks are not properly assessed, it can lead to ineffective utilization of resources, underperformance of the transportation system, as well as legal liabilities. Some of the techniques employed by risk managers in the Homeland Security sector were reviewed because this sector shares similar characteristics, such as the lack of historic data on events or threats.

In addition, this task concentrated on developing an integrated risk framework that supports the strategic objectives of selected case study DOTs. The dissertation research further developed a framework that is capable of evaluating the risks case study agencies face and is able to fit into existing asset management strategies within the organization. Furthermore, as part of this task, the dissertation developed a risk decision-support system that DOTs can use to evaluate and address risk in their budget planning and allocation efforts. This system can also help agencies monitor and improve their risk management programs.

The third and final task was to apply the framework to selected case studies and develop conclusions and recommendations. Eventually, conclusions are drawn based on the research outcomes. These conclusions involve the usefulness and applicability of the framework within any transportation decision-making process. The recommendations provide guidance to agencies or decision makers who apply the framework in their decision-making processes. The recommendations also address, how an agency can successfully implement this framework within its particular decision making process.

1.5 Scope

Both engineering and business practitioners use the term risk in various contexts. It is important for both asset managers and decision makers to make a clear distinction of the context within which one is applying the term. The FHWA has published a series of risk documents that offer guiding principles and establish context and direction for the application of risk in transportation

asset management (FHWA, 2012a; 2012b; 2012c; 2012d). This dissertation focuses on corridor-level risks associated with ancillary highway assets or hazards—typically internal threats—that can affect organizations’ planned program budget goals (strategic or programming risk).

These threats can cause decision makers to scramble for unbudgeted resources for emergency and unplanned infrastructure repairs, or introduce setbacks in meeting required system performance. In addition, this dissertation addresses economic, safety, and delay threats (operational risks) associated with potential hazards along a given corridor. This categorization of risk provides context to the proposed framework presented in this dissertation (chapter 4). The framework also provides flexibility for decision makers to incorporate additional risks deemed important to the successful operation of their transportation system or organization as a whole. Specifically, this framework focuses on addressing inherent risks across multiple asset categories or hazards on the corridor level -- for a transportation highway system.

1.6 Expected Results and Contributions

As a result of the literature reviewed, the work performed, and the motivation and objectives of this dissertation, the following results were expected as products of this work:

- a) An applicable unified risk framework that enables asset managers to prioritize critical ancillary highway assets and hazards into existing management systems to allow for a corridor-level risk analysis
- b) A risk decision-support tool to help asset managers implement the risk framework within the context of their organization
- c) Recommendations on how DOTs can adopt and incorporate the framework successfully into their existing asset management programs and also improve the benefits of the model

Eventually, it is expected that organizations adopting this unified approach in managing their transportation system can benefit from reducing system disruptions as well as increasing or maintaining system performance attributed to ancillary highway assets.

In addition, this research is expected to contribute to the state-of-practice and the body of knowledge of risk-based transportation asset management. To be precise, this work is expected to offer the following contributions:

- a) Provide an integrated framework and modified methodological approach for budget planning, prioritization, and resource allocation and utilization. This framework allows for risks to be weighed and prioritized for non-homogenous assets and hazards in transportation decision making.
- b) Allow DOTs to make effective use of existing ancillary asset data
- c) Bridge the gap between the management of core assets and ancillary assets and hazards
- d) Provide a practical tool for DOTs striving to meet the requirements of MAP-21
- e) Enable DOTs to effectively plan, improve, and monitor network risk

1.7 Dissertation Outline

This dissertation is organized and presented in six chapters. Chapter 1 presents the background, motivation, research questions, objectives, scope, and expected results and contributions of the study. The rest of this dissertation is organized as follows:

- Chapter 2 provides a synthesis of the literature reviewed. This chapter gives an overview of ancillary highway assets including their modes of failure and some notable failures in the United States. Furthermore, this chapter covers the state-of-practice of managing ancillary highway assets (AHA) and hazards among state DOTs. In addition, chapter 2 presents the basic concepts of risk by defining key terms and presenting different risk

frameworks as well as the state of application of risk management in transportation asset management. The chapter concludes with a concise presentation of the gaps identified in the literature.

- Chapter 3 discusses the underlying concepts to system-of-systems approach to corridor level infrastructure management.
- Chapter 4 entails an in-depth discussion of the proposed conceptual framework and the methodological approach developed in this work. The discussions include a step-by-step analysis of each component of the framework, the analytical concepts behind the proposed method, and how these concepts are used in seeking a solution to the research problem.
- Chapter 5 brings together the developed framework and method and implements the process in three different case studies. This chapter also discusses the results and practical implications of the results from the case studies.
- Chapter 6 presents the conclusions drawn from the study and recommendations to improve the potential benefits that can be derived from the framework and model. Finally, chapter 6 concludes with contributions of this research and recommendations for future work.

Chapter 2 ANCILLARY HIGHWAY ASSETS AND RISK-BASED DECISION MAKING

To plan for and manage the risks associated with the failure of ancillary highway assets (AHA) and the occurrence of hazards, one needs to know what types of asset constitute this group of transportation highway infrastructure. Furthermore, one has to be familiar with their modes of failure, and how the failure of these assets has affected the reliability and operation of a transportation network. In addition, having a good knowledge of how DOTs deal with these categories of assets can inform asset managers and decision makers in developing practical management strategies for these asset categories. Finally, if one is going to apply the principles of risk as a decision-support tool, it is imperative that one becomes well-versed with the basic concepts of risk and the extent to which DOTs or decision makers have adopted these concepts in their decision making processes. Accordingly, this chapter discusses all of these topics extensively. Three broad areas of literature were reviewed to inform the development of the framework. The TAM literature was reviewed to offer a comprehensive overview of the state-of-practice of TAM, with special reference to the management of ancillary highway assets. Risk applications in infrastructure decision making and supporting frameworks were also reviewed to characterize the nature of risk application in TAM. In addition, literature on the system-of-systems approach to infrastructure management was also reviewed to characterize infrastructure performance from a broader system-of-systems perspective for the transportation network. Chapter 2 discusses the first two areas of the literature (i.e., TAM and risk application in infrastructure decision making), and Chapter 3 reviews the third.

2.1 Overview of Ancillary Highway Assets and Hazards

In the initial years of TAM, requirements focused on pavement and bridge management (Cambridge Systematics et al., 2002). Recently, however, various organizations (both state DOTs and local agencies) have increasingly expanded their asset management activities to include the management of other categories of highway transportation assets such as pavement markings, sidewalks and curbs, street lighting, traffic signals, traffic signs, utilities and manholes, and earth retaining structures (FHWA, 2005; Li & Madanu, 2008; Hawkins & Smadi, 2013; Akofio-Sowah et al., 2014), with sidewalks and utilities and manholes predominantly managed at the local level. In addition to managing these categories of assets, a few DOTs have expanded their TAM programs to address other categories of hazards, such as sinkholes, rockfalls, and/or landslides commonly called unstable slopes. Appendix A shows examples of ancillary assets and hazards.

The collective management of these asset categories and hazards does not only account for accountability and good stewardship but these actions can also contribute to a safe and efficient operation of a transportation network. Generally, most of these asset categories are referred to as roadway safety hardware. Therefore, it is logical to expect that the systematic management of these asset categories can improve operational-safety conditions as well as address other functional needs. One way of improving these conditions and preserving this valuable stock of transportation infrastructure is to efficiently allocate and utilize limited resources (e.g., monetary and/or human resources, and time). Indeed, identifying high-risk asset or hazard categories and determining appropriate mitigation strategies are ways of managing transportation infrastructure more efficiently and effectively.

Such expansion of TAM activities to include AHA and hazards requires additional resources (i.e., monetary, man power, and time) for gathering and managing data and, in some cases, developing analytical tools. Given that transportation agencies or asset owners are usually resource constrained, these categories of ancillary assets and hazards will compete for formalized asset management programs or activities; and will likely benefit from logical and systematic prioritization procedures. Making a business case for managing various categories of assets and addressing potential categories of hazards can help transportation agencies prioritize the management of the assets and the hazards that yield the highest returns and minimize risks in the levels of service provided to system users (i.e., both in performance (i.e., non-catastrophic) and catastrophic failures). Employing risk analysis to identify opportunities also allows for decision makers to undertake tradeoff analysis among available policy options.

According to the FHWA, over 160 million sq. ft. of permanent earth retaining structures (ERSs) are constructed in the United States each year, and hundreds of millions of dollars are expended installing, repairing, upgrading, and replacing AHA (safety hardware) (Brutus & Tauber, 2009). The FHWA estimates that about 40 percent of these ERSs are on public projects (Brutus & Tauber, 2009). However, asset managers give relatively less attention to these critical components of the surface transportation system. Studies have identified that most DOTs allocate their safety hardware management program budgets according to sample condition assessment and expert opinion (Li & Madanu, 2008). However, at the time of increasing highway travel demand, aging infrastructure, and declining/insufficient transportation funds, more systematic approaches to managing AHA are crucial to addressing risks and meeting legislative mandates.

In fact, understanding the important role these asset categories play in the geometric design and operation of highways, incentives exist to warrant appropriate and practical management procedures. As transportation agencies and asset managers expand their management activities to include AHA, they may benefit from procedures that enable them to prioritize the different categories of assets for formal inclusion in their systems. This will mean that resource allocation for the management of AHA must be aligned with asset condition data (i.e., asset performance and vulnerability to failure), the risk of asset failure (i.e., probability and consequence of failure), and the agency's management/strategic objectives.

2.1.1 State of Practice of Ancillary Highway Asset and Hazard Management

The successful operation of a road segment, corridor, or transportation network requires the effective management and operation of more than two categories of assets: pavements and bridges. Nonetheless, over the years, these two asset categories have had an overwhelming emphasis in TAM due to supporting mandates and requirements. Examples of other tangible assets that contribute to the successful operation of a transportation network include all the categories of AHA mentioned earlier, which include, but are not limited to, culverts, signs, guardrails, overhead sign structures, ERS, and traffic signals. In addition to these asset categories, the transportation network faces potential hazards such as sinkholes and rockfalls/landslides (i.e., unstable slope locations) that are not tangible assets per se, but whose occurrence can be detrimental to the successful operation of a road segment, corridor, or the transportation network at large. Furthermore, the occurrence of these natural or manmade hazards can also result in both environmental and legal liabilities to an agency. Recognizing these negative impacts, some DOTs are systematically integrating these threats into their TAM programs. One example of a pioneering agency that systematically manages unstable slopes is

the Washington State DOT (WSDOT). WSDOT manages extensive highway facilities that traverse varying terrains with different geological characteristics. Appendix B shows the locations of unstable and mitigated slopes along state routes in Washington State.

Some complex geological environment surrounding some of their highways makes WSDOT highly vulnerable to the occurrence of rockfalls or landslides. The occurrence of such threats can raise the safety risk to system users, pose strategic risks to WSDOT, as well as affect commerce in the region. Accordingly, in 1995, through their highway preservation asset management program, WSDOT developed the Unstable Slope Management System (USMS) to address unstable slopes along the highways they maintain. Basically, the USMS addresses risks by prioritizing highly vulnerable unstable slope locations along the highway for proactive mitigation. Through these efforts, as of 2010, WSDOT has successfully mitigated over 228 high-risk unstable slopes (WSDOT, 2010). The overarching goal of WSDOT is to mitigate all identified high- and moderate- risk unstable slopes on interstate highways, principal arterials, and other roadways with moderate to high traffic volumes by the year 2020.

While asset managers can boast much about the existence of matured management systems (i.e., existence of deterioration models and extensive condition data) for pavements and bridges, relatively less can be said about the existence of decision-support systems for the management of AHA and hazards. This is not to suggest that asset managers strive to manage AHA and these natural hazards independently of pavements and bridges. Ultimately, a comprehensive TAM system involves the integrated management of the core transportation assets (i.e., pavements and bridges) and ancillary assets that make up the system. Evidently, the reasons for this shortcoming are the lack of resources and mandates that require DOTs to implement decision-support systems for AHA and hazards. Nevertheless, recently, a growing

number of agencies have been taking proactive steps in gathering and maintaining inventory for some categories of AHA and hazards. Indeed, over the years, the literature reveals a steady growth of DOTs gathering data on some categories of ancillary highway assets (Amekudzi, et al., 2011; Hawkins & Smadi, 2013).

In the absence of mandates for the systematic management of AHA, the practice is not uniform (i.e., setting performance targets, collecting data, or assessing conditions) among transportation agencies. However, the literature reveals that consistent improvements continue to occur in the management of AHA (Hawkins & Smadi, 2013). Although it is challenging to document the benefits of practicing AHA management, many agencies have taken a practical approach to gather inventory data on some asset categories (Amekudzi et al., 2011). A National Cooperative Highway Research Program (NCHRP) synthesis shows that 70 percent of the 43 responding agencies (State DOTs) indicated that they gather data for some categories of AHA (Hawkins & Smadi, 2013). Nonetheless, only 50 percent [of the 70 percent] indicated that they conduct condition assessments to allocate resources (Hawkins & Smadi, 2013). The study did not address the reason why the agencies selected those particular categories of AHA for data gathering. Often, these types of decisions are executive decisions based on limited inputs from experts. For instance, in WSDOT, senior executives decided against spending resources to create a formal collection and condition assessment program for retaining walls¹. This decision was taken in 1994 when WSDOT explored the need to establish this system and found little history on failure rate and the need to have a formal preservation system for ERSs or retaining walls.

¹ Operations & Asset Management, Office of Capital Program Development and Management, Washington State Department of Transportation

In 2010, Akofio-Sowah et al. conducted a study on the state of practice of ancillary transportation asset management. The study involved a survey of selected state DOTs and local agencies and focused on the following categories of AHA: ERS, culverts, traffic signs, pavement markings, traffic signals, street lighting, sidewalks and curbs, mitigation features, and utilities and manholes. The results from the survey showed that the practice of AHA management is dynamic among agencies, depending on the maturity level of their entire TAM program (Akofio-Sowah et al., 2014).

The study results further showed that 50 percent of the responding agencies indicated they had systems in place for six different categories of AHA. On the other hand, none of the responding agencies indicated that they had a system for all the 10 different categories of ancillary highway assets the study considered. This latter finding is motivating because it sets a premise for this research. The challenging question agencies may want to answer, as they phase-in different assets into their existing formal asset management systems is which categories of AHAs ought to be prioritized? When it comes to AHAs, the most persuasive approach to justify their management to decision makers is to consider their risk of failure, i.e., both the probability and consequence of failure and the impact on organizational objectives.

2.1.2 Failure Modes of Ancillary Highway Assets

Ancillary highway assets, similar to any transportation infrastructure, can fail either catastrophically or non-catastrophically (performance failure). Failure is termed catastrophic if a system or a structure suddenly fails beyond the point of its usage. When this failure occurs, recovery is not possible. As such, this form of failure automatically requires a rebuild or replacement of the system or structure.

An example of a catastrophic failure is the sudden collapse of a section of an ERS in hilly northern Manhattan onto the Henry Hudson Parkway in 2005. On the other hand, non-catastrophic failure, also known as performance failure, occurs when the service level of a system or infrastructure falls below a performance target that asset managers or decision makers have predetermined. This type of failure can be restored by the asset manager, through the undertaking of a specific maintenance or rehabilitation procedure to restore the required level of service. The cost of such restoration procedures is relatively cheaper than rebuilding the system or infrastructure. However, a prolonged or unattended performance failure can lead to a catastrophic failure that requires complete replacement of a system or infrastructure. On the contrary, unstable slopes (rockfalls or landslides) usually fail catastrophically due to their natural characteristics. The consequences of occurrence of a rockfall or landslide depend on the extent of failure and their impact on the surrounding infrastructure, system users and surrounding communities. Although their occurrence can be unpredictable, assessing their impact upon failure and instituting proactive mitigation strategies can reduce the probability and consequences of occurrence.

2.1.3 Examples of Notable Failures of Ancillary Highway Assets

Although the failure and occurrence rate of ancillary assets and hazards are relatively low, their consequences can sometimes be fatal, in addition to the consequential economic (direct and indirect) burden they present to asset managers and the system users. Due to the low costs of these assets, usually, very few receive public or media attention when they fail, unless the failure involves fatalities or significant delay to system users. Typically, the failure of these types of assets rarely results in safety concerns (i.e., injuries or fatalities). However, the consequences of failure manifest in cost burden (i.e., direct and indirect). Directly, an agency

has to bear the cost of replacing or repairing the failed asset or clearing a roadway of debris resulting from a rockfall or landslide. Usually, these repairs constitute emergency costs that are typically higher than routine or strategic programming cost (Anderson & Rivers, 2013). Similarly, indirect costs (i.e., costs to system users associated with delays and congestion) resulting from an asset failure or the occurrence of a rockfall or landslide become a burden to the taxpayer. Ultimately, because ancillary assets occur in high volumes, accumulation of their failure impact over time can have significant impacts on an agency's ability to achieve its strategic objectives. This section presents some examples of asset and slope failures that had significant impacts enough to warrant public and media attention. Figure 2.1 through Figure 2.7 show examples of catastrophic or performance failure of a culvert, an ERS, cantilever sign structure, guardrail, sign, landslide, and rockfall hazard.

Figure 2.1 is a result of a failed culvert on a portion of Interstate-88 in New York, in 2006. The failure resulted in two fatalities, loss of all four lanes and the entire median. Figure 2.2 shows the collapse of a section of an ERS in hilly northern Manhattan onto the Henry Hudson Parkway. This failure occurred in 2005, and sent tons of dirt, rocks, and trees onto the roadway, stopping traffic for miles, and leading to the evacuation of nearby buildings. Figure 2.6 shows a rockfall incident on I-70 in Colorado, which created a hole in a bridge deck and caused the bridge to be closed down, causing 200 miles of detour affecting about 250,000 vehicles a day (Anderson & Rivers, 2013). In addition to these failures, Table 2.1 shows the documentation of a few culvert failures within the United States and their associated consequences (Perrin, April 2006).



**Figure 2.1 Culvert failure on Interstate-88 in New York
(New York State Police Department, June, 2006)**



**Figure 2.2 Failed ERS along Riverside Drive near Manhattan in New York
(The New York Times, May 13, 2005)**



**Figure 2.3 A Failed Cantilever Overhead-Sign Structure
(Garlich & Thorkildsen, 2005)**



**Figure 2.4 Underperforming Guardrails
(Kim, et al., 2009)**



Figure 2.5 Example of a Failing Road Sign



**Figure 2.6 Rockfall in Glenwood Canyon, Colorado
(Anderson & Rivers, 2013)**



**Figure 2.7 Debris Flow of Landslide Shuts Down Roadway
(WSDOT, 2010)**

**Table 2.1 Examples of Culvert Failures and Consequences in the United States
(Perrin, April 2006)**

Location	I-70-CO	I-480-OH	SR 79-OH	5400 S-UT	I-70 -CO Eisenhower	Prudenville- MI
Pipe Size / Type	66" CMP	60" CMP	30" CMP	72" CMP	60" CMP	73"x55" ellipse, CMP
Costs of Replacement (\$)	4,200,000	384,000	NA	48,000	45,000	95,000
Length (ft)	85-100'		50'	50'	40'	50'
Days	49	8	6	5	7	6
Impacted AADT	20950	16760	4920	19338	1257	5100
Delay	120 min	60 min	20 min.	20 min.	30 min	20 min
User Cost (\$)	4,046,000	3,079,000	290,000	693,000	220,000	249,000
Total Costs (\$)	8,246,000	3,463,000		741,000	265,000	344,000
Age (yrs)	35-60	60	30+	20	30	30
% Construction	51	11		6	17	28
% User cost	49	89		94	83	72
Normal Replacement cost	\$18,000-50yr \$30,000 - 100 yr	\$15,000 - 50 yr \$28,000-100yr	NA	\$7,200 -20 yr \$13,400-100 yr	NA	NA
Total Emergency Replacement Cost	4,200,000	384,000	NA	47,800	45,000	95,000
ERF	140	14	NA	4	NA	
Number of Replacements	1	1	3	4	2	2
Emergency Replacement Installation Costs (2003 \$)	4,200,000	384,000	NA	192,000	90,000	190,000
User Delay Costs for all Replacements (2003 \$)	4,046,000	3,079,000	870,000	2,772,000	440,000	498,000
Total Costs for 100 yr Horizon (2003 \$)	8,046,000	3,463,000	NA	2,964,000	530,000	688,000
Estimated Cost to change to 100 year pipe (2003 \$)	12,000	13,000	NA	6,200	4,500	6,200
Benefit/ Cost Ratio	671	266	NA	478	118	111

All cost rounded to nearest \$1,000

2.1.4 The Importance of Managing Ancillary Highway Assets

Integrating AHA decision-support systems into TAM decision-making frameworks directly or indirectly offers beneficial returns to stakeholders (both owners and users). Research suggests that the incremental benefits of asset management are difficult to measure explicitly. However, researchers have documented beneficial experiences of DOTs with matured asset management systems (EPA et al., 2009). The primary reason for managing AHA is to reduce the costs associated with keeping these assets in a state-of-good repair, over their service lives.

Another important reason for asset managers to systematically manage their ancillary assets is to reduce the risks associated with the failure of these assets, causing road closures, reducing capacity, and degrading the level of service (LOS). Although AHA, in general, do not provide the primary service required of a transportation network, they, however, provide complementary services that affect the ultimate performance of a transportation network. As such, the failure of ancillary assets can lead to the failure, or underperformance, of an entire road segment, corridor, or a network. On the other hand, the better management of these asset categories can offer benefits as well. Conversely, the underperformance (functional or condition) of ancillary assets presents potential risks liabilities to decision makers or transportation network users. Examples of these risks are the inability for an agency to meet system performance/operational goals (e.g., safety or congestion goals) and strategic or organizational goals (e.g., avoiding emergency repair costs or legal liabilities, meeting federal requirements, or gaining public trust).

2.2 Risk Management and Infrastructure Investment Decision Making

Over the years, risk managers and decision makers have employed risk analysis as a decision aid. In fact, risk management has become commonplace in management practice. That is, most

practitioners and decision makers consider risk a fundamental component of management. Certainly, risk applications for resource allocation and other functions can be found in the management of geographically-distributed critical infrastructure, such as transportation, waste water, and water infrastructure. Indeed, several transportation agencies, both domestic and international, have acknowledged the significance of incorporating risk in their decision-making processes of budget planning and allocation, and project prioritization (Brutus & Tauber, 2009). In addition, the number of transportation agencies considering risk applications to enhance their TAM programs continues to increase (FHWA, 2005). In the following subsections, the dissertation discusses risk decision making in general and explains some terminologies in risk decision making.

2.2.1 Overview of Risk-based Decision Making

Many organizations, or fields, have defined risk in diverse ways. For example, the International Organization for Standards' (ISO) 31000, which provides principles and generic guidelines on risk management, defines risk as the effect of uncertainty on objectives (IIMM, 2011). Accordingly, on one hand, risk can be generally defined to include any event that can hinder an organization from achieving its goals. When defined in this manner, risk is, therefore, categorized as only negative outcomes. However, risk can also be classified as positive risk, in which case opportunities exist. When opportunities are identified in the risk decision-making process, the practice presents prospects for decision makers to perform tradeoff analysis. In this scenario, decision makers can conceptualize the benefits to their system if a performance target is lowered, and this can help them to think about their preferences in complex situations. As such, decision makers can capitalize on the savings made for not undertaking a particular maintenance or preservation activity.

2.3 Key Terminologies of Risk

In order for decision makers to address the risks inherent in the operation of their systems and in their business functions, they must understand the basic concepts and key terms that characterize the principles of risk. As such, this dissertation provides the following definitions, as applied in this thesis. Although there are no universally-accepted definitions for these terms, the clarification of the concepts and terminologies presented in this research is useful; therefore, the following discussion serves to provide a common vocabulary for this research to eliminate possible ambiguities.

2.3.1 Hazard

In general, a hazard is anything, active or inactive, that can cause harm to a person, an entity, or a system. In our social everyday life, we deal with hazards consciously or unconsciously. Fortunately, through experience, we are trained to deal with the hazards we encounter. For example, crossing a major intersection is a hazard; however, we are trained to look in both directions of the road, to ensure that there are no approaching vehicles, and can thus mitigate or eliminate the impending hazard. We can identify many of such examples in our everyday activities. Similarly, in engineering and scientific systems, hazards exist. Engineering systems, such as transportation, water, or nuclear systems, encounter many hazards. System hazards can be natural or manmade. Examples of natural hazards are earthquakes, hurricanes, rockfalls, landslides, or floods. Manmade hazards can include failure to maintain systems to function properly or failure to implement an intervention at the appropriate time. Generally, a transportation system is vulnerable to both natural and manmade hazards that need to be mitigated to ensure the smooth operation of the system.

While manmade hazards can be easily identified and mitigated, natural hazards on the other hand are difficult to plan against. Nonetheless, better assessment and preparation can help reduce the impacts and recovery time when natural hazards do occur. Whether the hazard is voluntary or involuntary, there is the need to address it (i.e., identify and mitigate or eliminate the hazard). To address potential hazards, risk analysts have to understand the magnitude of the hazards upon occurrence. The magnitude of a hazard can be estimated by understanding the harm or the immediate danger it may cause and the extent to which the hazard will affect a system or users of a system when it occurs.

2.3.2 Vulnerability

A person or system's inability to resist a hazard is the person or system's measure of vulnerability. In other words, vulnerability measures how a person or a system can withstand a potential hazard upon occurrence. A system's vulnerability to failure depends on many factors, such as the age of the system, the type of engineering design, or historical maintenance activities. Primarily, vulnerability of an asset to failure focuses on the assets' conditions (Meyer, et al., 2014). Generally, through vulnerability assessment, one is able to identify which systems or assets are highly susceptible to failure. Following this identification, decision makers can develop and institute the necessary mitigation procedures to ameliorate the situation. For example, a culvert will be able to carry more storm-water to prevent flooding of a highway if preventive maintenance of the culvert is effective. Accordingly, the culvert can be said to be less vulnerable to failure during a rain storm.

Similarly, a rockfall may not reach the main travel lanes of a highway if an appropriate catchment area is designed. Other examples also include building higher elevation bridges to prevent bridge sections from washing away in the situation of hurricanes or flooding. There are

several other situations that decrease or increase the vulnerability of a system to failure. Systems engineers can identify such situations, so that they are well-informed in planning and programming to prevent disasters, reduce failure risks, or avoid unnecessary costs. A vulnerable system can lead to loss of benefits, economic, social, or political.

2.3.3 Uncertainty

As a result of sparse data and incomplete knowledge of a system in the decision-making process, uncertainty arises (Harrison, 2005). Uncertainty also exists as a result of the inherent randomness associated with systems and events (Harrison, 2005). Three different types of errors contribute to uncertainty in risk-based decision making in infrastructure planning or management: data errors, modeling errors, and forecasting errors. Decision makers make decisions using suitable available data by extrapolation. The outcome of such extrapolations depends on the uncertainties surrounding the information that decision makers use. For example, Amekudzi and McNeil demonstrate the impact of data and model uncertainties associated with highway investment needs analysis (Amekudzi & McNeil, 2000). That is, how do these uncertainties impact the optimal solution?

Other studies have also shown that making small adjustments to input parameters can significantly impact the optimal decisions of maintenance programs (Helton & Burnmaster, 1996). In fact, the level of confidence in the decisions made from the use of these outputs depends on the quality and accuracy of the input data. Although practitioners can reduce these errors through the use of statistical models, it must be noted that the extent of reduction of these errors is limited. Pate-Cornell discusses when and why a full uncertainty analysis is justified because of the complexity and cost involved (Pate-Cornell, 1996). That is, decision makers can perform tradeoff analysis to evaluate the returns associated with acquiring extra data for the

pending analysis. Regardless of the cost, the process of reducing uncertainty helps to represent risks with increasing levels of confidence.

2.3.4 Probability of Occurrence

The probability of occurrence of an event or a hazard is a measure of the likelihood that the event or hazard will occur. This likelihood can be measured either on a nominal or ordinal scale. Depending on data availability, the probability of occurrence of some imminent event or hazard can sometimes be calculated precisely with no uncertainty. On the other hand, the probability of occurrence of other rare hazards or events, however, are forecasted or predicted with a considerable amount of uncertainty, using sparse data or engineering judgment and expert knowledge.

The ability of systems engineers to accurately estimate the likelihood of an event or a hazard leads to proper preparation or mitigation procedures to limit the negative impact and the extent of the event or hazard. This process contributes to or ensures the reliability of a system. The reliability of a system is defined as the ability of the system to perform its design functions under designated operating or environmental conditions for a specified time period (Ayyub, 2003). In other words, the reliability of a system can be estimated from the system's ability to perform in the face of the event or hazard occurring and disrupting the functions of the systems. As such, the reliability of a system can be represented as:

$$\text{Reliability} = 1 - \text{Probability of occurrence/failure.}$$

2.3.5 Event Consequence

The consequences of an event can be negative or positive. The value of the consequence depends on the magnitude and extent of the loss or gain resulting from the event or hazard. There are different broad categories of consequences: economic, social, or environmental. In

engineering or systems operation, decision makers are mostly interested in identifying negative consequences since society does not condemn gains. However, for budget planning and resource allocation utilization purposes, positive consequences or opportunities are critical for decision makers to evaluate tradeoffs.

To facilitate effective risk analysis, it is imperative that decision makers quantify the consequences in terms of a measurable quantity (i.e., quantitative or qualitative). Systems engineers or decision makers can accomplish this process by employing failure-consequence severities using relative or absolute measures for various types of consequences (Ayyub, 2003). This consequence quantification process is data intensive if decision makers use absolute measures to accomplish the task. On the other hand, if data is sparse or limited, decision makers can quantify event consequences using relative measures. For the most part, the relative measure approach requires elicitation of expert knowledge and engineering judgments.

2.3.6 Risks

The potential for negative or positive events and consequences constitute opportunities for risk. In the context of safety, risk is viewed as a negative consequence. Thus, in a safety context, the focus of addressing risk is to mitigate the negative consequences. As mentioned earlier, risk can be defined in various ways depending on context. Despite the variations in all the definitions, they all acknowledge two main characteristics related to uncertainty and consequences. The *Webster's Collegiate Dictionary* defines risk as the chance of loss, the degree of probability of loss, the amount of possible loss, or the type of loss that an insurance policy covers.

In the literature, the definition of risk usually makes reference to an uncertain cause that results in some sort of damage to an existing entity. This uncertain cause is usually referred to as

a risk event or threat. In other words, risk exists only because there is uncertainty. Therefore, one can characterize risk as a measure of some future uncertainties in achieving program performance goals and objectives, or fulfilling organizational business functions. As such, once the uncertainty [or threat] is addressed, the risk due to the identified hazard or event ceases to exist. Therefore, one cannot define the risk of a historical event or an event currently happening (Ayyub, 2003). In risk decision making, decision makers are confronted with two types of threats that can result in negative risk situations. Figure 2.8 shows a hierarchical structure of risk and threats as applied in infrastructure risk decision making. Essentially, decision makers can categorize inherent threats as internal or external. Primarily, internal threats result from events that can be controlled or influenced by the deliberate actions or inactions of decision makers. In other words, decision makers or organizations have the capability to identify, address, or mitigate the effects of risks resulting from internal threats. For instance, a timely maintenance intervention on transportation infrastructure can prevent failure (performance or catastrophic). On the other hand, a delayed intervention can result in infrastructure failure leading to unwanted risks.

Conversely, decision makers or organizations have limited control on risks resulting from external threats. That is, external threat events have actors that are beyond the control of organizations or decision makers. Examples of external threats on transportation infrastructure are earthquake, flooding, and other natural disasters. Other external threats also include actions and inactions of external agencies that work as partners or contractors with a primary organization or decision maker. Although decision makers have limited control in mitigating external threats, better preparation to mitigate risks resulting from external threats can help alleviate their impacts when they occur.



Figure 2.8 Classification of Risks and Threats

In the context of technical risk analysis, a numerical value is assigned to the risk (Lofsted & Boholm, 2009). This value is obtained by multiplying the probability of the risk event by the consequence of the event, as illustrated by equation 2.1. As an illustration, consider n potential consequences resulting from n potential likelihoods of future events. Then, risk can be defined quantitatively as a collection of n pairs.

$$\text{Risk} = \{(L_1, O_1), \dots, (L_n, O_n)\}, \dots \text{equation 2.1}$$

where O_n and L_n denote the consequences (i.e., outcomes) of n and its likelihood, respectively.

However, the formulation of risk in this form for decision making fails to incorporate the societal dimensions of risk (i.e., the political and ethical dimensions of risk are not taken into account) (Lofsted & Boholm, 2009).

Ultimately, a good risk program should address the potential variations that may result between the planned approach and the expected outcome. This characterization of risk,

therefore, involves both positive and negative dimensions of the planning processes. Since opportunities contribute to better outcomes whereas negative dimensions take away from the possibility of achieving possible goals, programs tend to suffer mostly from the negative effects; hence, decision makers and program managers are usually more concerned with the negative effects for better operations.

2.3.7 Risk Appetite and Tolerance

Risk appetite is a fundamental consideration in any risk management approach. The risk appetite of an individual or an organization measures the nature and the extent of the significant risk an individual or an organization is willing to accept to achieve its strategic and operational objectives. Guide 73 of the International Organization for Standardization (ISO, 2002) defines risk appetite as the “amount and type of risk that an organization is willing to pursue or retain.” Basically, the risk appetite of a decision maker or an entity defines the boundaries or thresholds of risk and the type of treatment (mitigation procedure) to apply. Risk appetite can vary among or within an organization, as well as decision makers. Risk appetite tends to be dynamic in nature, developing from the existing situation of the organization in terms of achieving its strategic and operational objectives. Depending on the risk appetite of an entity, risk managers or decision makers can be classified into three categories of risk takers: risk seeking, risk averse, or risk neutral.

While risk appetite defines or deals with identifying which risks a decision maker or an organization treats and how to treat the risk, on the other hand, risk tolerance determines the magnitude of risks that an organization or a decision maker is willing to deal with. Decision makers or risk analysts express risk tolerance in absolute values, with respect to a performance measure (Anderson R. , 2011). For example, a transportation agency can set a mobility risk

tolerance as: “we will not accept more than x% speed reduction below the posted speed limit during peak hours.” Without a well-defined and measurable risk tolerance level, the risk management process becomes ineffective. Although risk tolerance is practically difficult to set, the literature offers decision makers and risk managers some guiding principles to accomplish this process (Anderson R. , 2011). The concepts of risk appetite and tolerance, and performance measures are interrelated in risk management and decision making.

Although system analysts and decision makers are usually comfortable in setting performance targets, these professionals find it very challenging in doing the same for the other two variables: risk appetite and risk tolerance. This challenge is due to the fact that decision makers, especially in the public sector, are unwilling to accept legal liabilities in choosing and documenting such measures knowing that some adverse events may occur where the safety and the welfare of the general public is at stake. Unlike the public sector, the private sector is able to select and document appropriate risk appetite and risk tolerance levels because their decisions are driven by profit. Figure 2.9 to Figure 2.13 explain the relationships among these concepts (Anderson R. , 2011). Figure 2.11 illustrates the risk universe of an organization; defined as the full range of risks which could impact, either positively or negatively, on the ability of the organization to achieve its long term objectives (Anderson R. , 2011).

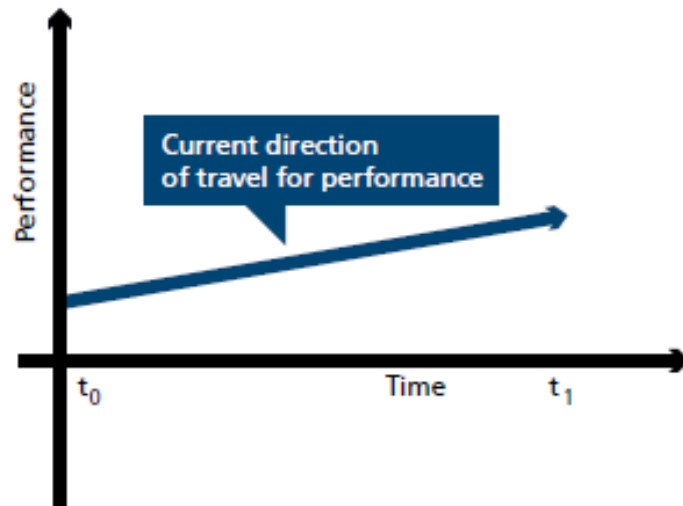

Figure 2.9 Performance over Time Uncertainty

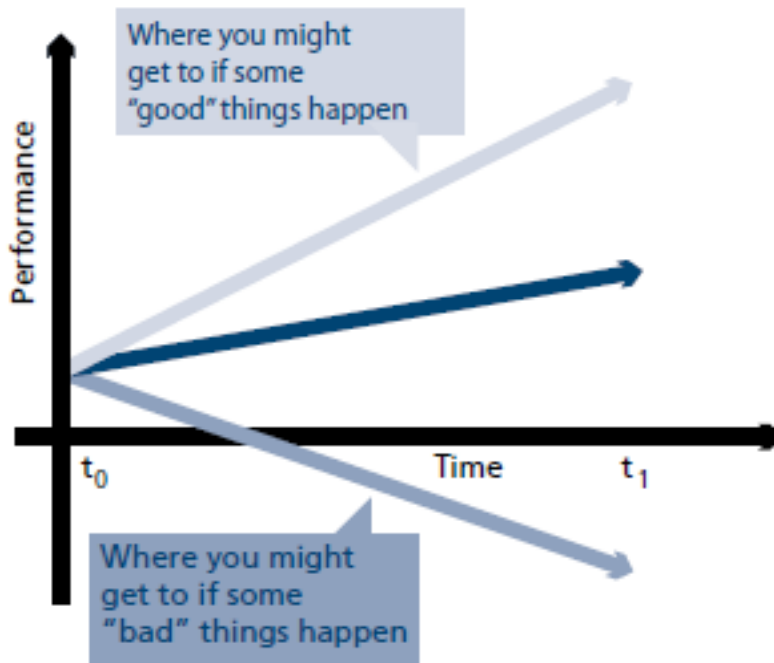

Figure 2.10 Performance Measure with Uncertainty

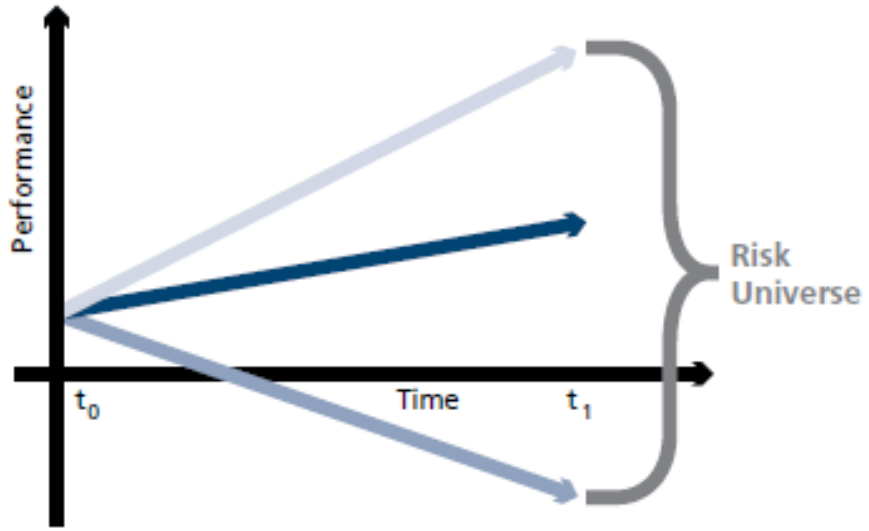

Figure 2.11 Agency Risk Universe Level

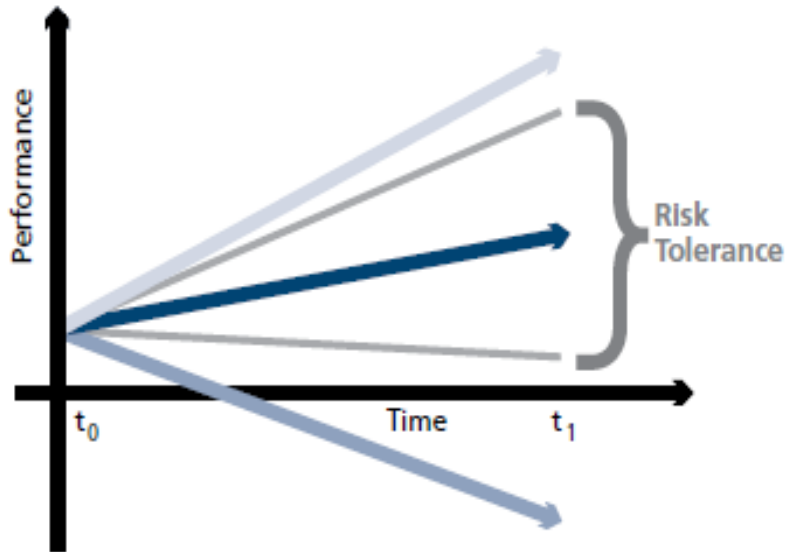

Figure 2.12 Agency Risk Tolerance Level

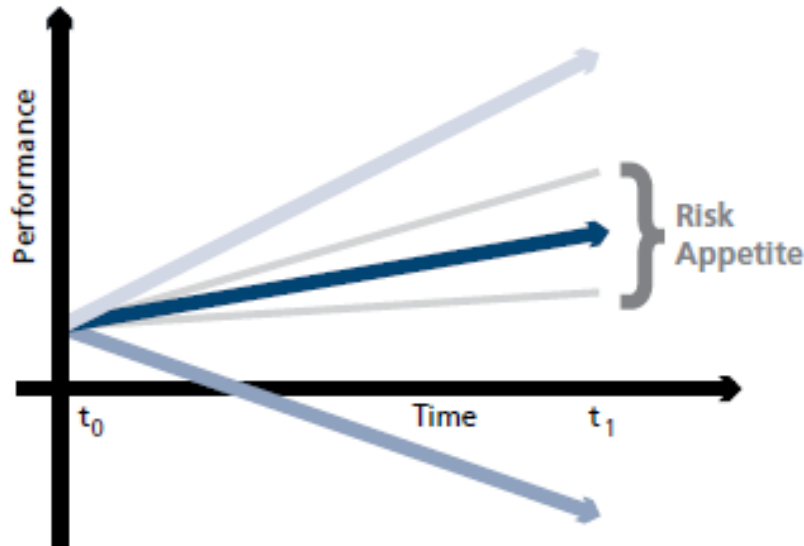

Figure 2.13 Agency Risk Appetite Level

2.4 Types of Risk Analysis Levels

The United States Department of Transportation (USDOT) and FHWA recognize that risk management is critical to the transportation asset management programs DOTs have (FHWA, August 2012). The purpose of addressing risk in the planning, construction, operation, and maintenance phases of transportation infrastructure is to help ensure decision makers allocate and utilize resources effectively to meet strategic and operational objectives of their organization over the life cycle of their assets. The process also helps decision makers to communicate to stakeholders (including system users) the procedure of uncovering, determining the scope of, and managing all the levels of uncertainties.

Since risk can be associated with all aspects of an agency's activities, it is important to distinguish the different levels of risk management to help decision makers in addressing uncertainties. In fact, the objectives and events a decision maker considers during the risk assessment determine the scope or level of risk under consideration. For instance, in dealing with security risks, the United States Department of Homeland Security (DHS) identifies three

categories of risk an organization can deal with: strategic, operational, and institutional (USDHS, 2011). Table 2.2 defines and describes all these categories of risk. Similarly, in infrastructure management, decision makers deal with risk at the project, system/operational, program, and enterprise/strategic level. To effectively manage these types of risk, decision makers must scope and understand the level they are dealing with and how the level of uncertainties impact the activities of their agency.

Project risk analysis, which is the lowest form of risk analysis, deals with the risk associated with different projects. Examples of risks that decision makers or risk managers encounter include the risk of cost overrun, scheduling, or safety at the job site.

System/operational risk analysis involves risk associated with performance, condition, or failure of the physical infrastructure or the network as an entity. Enterprise risk analysis, which is the highest form of risk analysis, on the other hand, deals with risk associated with an entire organization and its business practices.

Examples that illustrate enterprise risk include the risk of losing experienced personnel with no immediate replacement, the risk of not meeting legislative mandates, or the risk of change in a politically-elected official who supports a direction the agency has embarked. Enterprise-risk management recognizes the fundamental importance of proper management of risks associated with a transportation agency's functions and activities. In-between these two is program risk management, which deals with program-level risk analysis.

**Table 2.2 DHS Categorization of Risk
(USDHS, 2011)**

Characteristics	Strategic Risks	Operational Risks	Institutional Risks
Definition	Risk that affects an organization’s vital interests or execution of a chosen strategy, whether imposed by external threats or arising from flawed or poorly implemented strategy.	Risk that has the potential to impede the successful execution of operations with existing resources, capabilities, and strategies.	Risk associated with an organization’s ability to develop and maintain effective management practices, control systems, and flexibility and adaptability to meet organizational requirements.
Description	These risks threaten an organization’s ability to achieve its strategy, as well as position itself to recognize, anticipate, and respond to future trends, conditions, and challenges. Strategic risks include those factors that may impact the organization’s overall objectives and long-term goals.	Operational risks include those that impact personnel, time, materials, equipment, tactics, techniques, information technology, and procedures that enable an organization to achieve its mission objectives.	These risks are less obvious and typically come from within an organization. Institutional risks include factors that can threaten an organization’s ability to organize, recruit, train, support, and integrate the organization to meet all specified operational and administrative requirements.

2.5 Risk Assessment and Risk Management

Risks associated with the failure of AHA (operational risk), or the risks associated with an agency’s inability to meet legislative mandates or budget (strategic/enterprise risk) can be managed effectively only if the risks are assessed correctly. The meaning of the term management may vary in many ways depending on the discipline and/or context in which it is used (Haimes, 2009). Risk assessment and risk management, which remain essential components of any asset management process, are two distinctive processes; however, the term

risk management is sometimes used to describe both the risk assessment and risk management processes (Haimes, 2009). Risk assessment refers to the scientific process of measuring risks in a quantitative and practical manner.

Kaplan and Garrick describe the risk assessment process as an attempt to answer a set of three questions: What can go wrong, what is the likelihood that it would go wrong, and what are the consequences? (Kaplan & Garrick, 1981). Through these three questions, the inherent risks are identified, measured, quantified, and evaluated, and subsequently, their consequences and impacts established. Effectively, the risk assessment process objectively accomplishes an assessment to foresee negative effects or hazards and to identify opportunities. Subsequently, risk managers and decision makers can use this information to minimize adverse consequences while they also capitalize on rising opportunities. The assessment process identifies a single event or a sequence of events that can lead to these adverse consequences or otherwise. These single events or sequences of events are called scenarios.

Examples of such events, in terms of systems operational risk, could be the failure of a traffic signal, the failure of a pavement marking, the failure of a sign, the occurrence of a sinkhole, rockfall/landslide, or the failure of a culvert. Any of these events can lead to consequences: higher costs of repair, reduction in segment capacity, reduction in corridor or network mobility, fatalities, or delay in travel time. The risk assessment process is dependent on data quality, the views, the knowledge, and the experience of individuals or experts.

Unlike risk assessment, risk management is a qualitative process that involves the selection and implementation of a risk mitigation strategy that alleviates or accepts the specific risk under consideration (Haimes, 2009). As such, a risk management process requires risk managers to define acceptable risks. Risk management, which focuses on addressing

uncertainties in a proactive manner in order to minimize threats, maximize opportunities, and optimize achievement of objectives, is a proper platform for solving critical infrastructure preservation tasks. That is, risk management is performed within an economic framework, so that decision makers can optimize their resource allocation and utilization decision-making process (Ayyub, 2003).

In addition, the risk management process attempts to answer three main questions (Haimes, 2009): What are the available options, what are the associated tradeoffs, and what are the impacts of current decisions on future options? These questions build up from the risk assessment process. The last question, which evaluates the impacts of current decisions on future options, is the most critical of all the three questions, for managerial decision making (Haimes & Jiang, 2001).

In order to believe that a decision made is optimal or reflects the desired tradeoffs of decision makers and their stakeholders, policy makers would have to ascertain that they have reasonably optimized the benefits of current decisions with respect to future options. This is achieved by weighing the negative and positive effects of current decisions on future decisions. In the context of transportation asset management, AASHTO defines risk management as “a process of identifying sources of risk, evaluating them, and integrating mitigation actions and strategies into routine business functions of the agency” (AASHTO, 2011). This definition implies that risk management is an ongoing process that continues throughout the existence of an organization.

2.6 Risk Management Plan

In the previous sections, risk and risk management have been carefully discussed. Risk is an event or condition that, if it occurs, could have a positive or negative effect on an agency’s goals

or objectives. Risk Management is the process of identifying, assessing, responding to, monitoring and controlling, and reporting risks. The success of every program within an organization depends on the plan in place for the execution of the program. Similarly, for a risk management program to produce any meaningful results, decision makers will have to establish a well-defined plan that guides the process. Thus, a risk management plan defines how the risks associated with an organization or a program will be identified, analyzed, and managed. The main purpose of a risk management plan is to outline how an organization performs, records, and monitors all risk management activities throughout the organization. A risk plan also provides decision makers and risk managers with procedures for prioritizing risks. Essentially, a risk management plan documents the practices, responsibilities, tools, and procedures that decision makers or risk managers will use to manage and control those events that can impact (positive or negative) the goals and objectives of an organization.

In the process of developing a risk management plan, there exists a variety of standards that one can use as a guide. Usually, the guide one adopts depends on the background or field of the practitioner. However, in infrastructure management, there are some authoritative documents that provide useful guidelines for developing a risk management plan: the international infrastructure management manual and ISO 31000. These documents enable one to build a systematic risk process capable of transforming an organization's goals into reality while reducing their risks. For an organization to experience the full benefits of its risk management program, risks related to the organization and its infrastructure must be properly identified and documented based on a systematic methodology within proper and workable guidelines. With the help of these guidelines or risk management plan, decision makers or risk managers can take appropriate proactive measures to mitigate apparent vulnerabilities to failure as well as

ameliorate business and operational risks. Indeed, decision makers or risk managers can prevent small events from evolving into major issues or emergencies by developing an effective risk management plan. Ultimately, a risk management plan can help decision makers in dealing with adverse situations when they arise and, hopefully, identify and deal with these situations before they occur. Over the long term, transportation practitioners can benefit from developing practical risk management plans for their transportation systems. Fortunately, MAP-21 establishes a provision that requires State DOTs to institute this obligation.

2.7 Risk Management Framework

A risk management framework is a set of components that support and sustain risk management throughout an organization (ISO, 2009). These components range from identification of a problem to mitigation practices. The structure of a risk management framework is illustrated in a variety of ways in the literature. However, these structures often share common steps, although sometimes different terminologies are used to describe the same step. That is, even though these risk frameworks can be different terminologically, they are similar in functional elements and process. This situation arises as a result of different fields adopting different languages. One can be certain that the type of structure or terms one uses in developing a risk management framework is influenced by many different international standards, such as the Canadian risk standards, Australian-New Zealand risk standards, or the ISO standards. There are some other agency standards that have emerged and influenced the way decision makers structure their risk frameworks. Examples of these agencies include the Department of Homeland Security (DHS), Federal Emergency Management Agency (FEMA), Federal Highway Administration (FHWA), and other agencies. Figure 2.14 illustrates a typical FHWA risk management framework.

Appendix C presents examples of some ISO and agency specific risk frameworks.

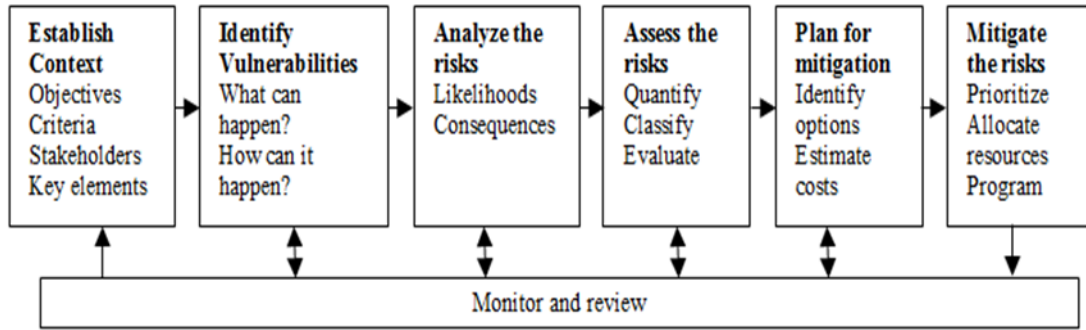

Figure 2.14 Typical Risk Management Framework (AASHTO, 2011)

This framework outlines the typical seven-step process of managing risk. This outline is a generic structure which does not include specific steps that will be relevant only to specific applications. However, the outlined steps cover all the necessary steps relevant for undertaking any risk management task. In this scenario, the risk management process refers to the initial step of establishing context through to the mitigation and monitoring processes. It is important to note that the directional arrows do not necessarily imply the process is a unidirectional process but rather an iterative procedure. As such, a task one undertakes or information one acquires now is capable of informing a prior task and hence influencing a change in practice at that level or step. That is, each activity one undertakes at each step is an opportunity to improve or inform other steps and, eventually, the entire risk management process.

2.8 Risk Quantification Methods

Within a risk framework exists the risk assessment step that basically involves the process of quantifying, classifying, and evaluating the risk. The process of quantifying risk remains challenging to infrastructure managers especially when data is scarce, when dealing with multi-dimensional risks, or when one cannot assign exact value to an outcome. Traditionally, analysts have quantified risk using a product of the probability or likelihood of an event and the

consequences of the event as it occurs. However, this form of risk quantification and other methods, such as the Monte Carlo simulation, require specific intensive data (e.g., monetary values and probability functions) associated with the risk event. For one to employ this approach of quantifying risk, one must be in a better position of assessing statistical/historic data as well as defining a probability distribution that characterizes the event. However, with continual advances in decision making, the need to consider risk in novel areas of decision making, and the lack of specific data have rendered this approach of quantifying risk less practical.

For example, the needs to consider risk as a multifaceted problem and in other decision quarters, that have limited data, have led to other novel approaches in risk quantification. Although some of the emerging techniques are less quantitative-based, analysts are developing more robust techniques that combine both qualitative and limited quantitative information to make the decision process more objective. These efforts come as a result of the increasing pressure for more quantitative risk assessment practices. In determining the appropriate technique to adopt in the estimation process, researchers or practitioners can use the following guiding questions (Hubbard, 2010): 1) what are the parts of the problem one is uncertain about? 2) How has the problem been treated previously by others? 3) How do the “observables” identified lend themselves to measurements? 4) How much do we really need to measure? 5) What are the sources of error? 6) What instrument (survey, test, etc.) do we select? In the following sections, the dissertation discusses two most common risk methods analysts are employing to quantify risk; especially, in transportation asset management and other areas, such as homeland security and disaster management, where value quantification is challenging.

2.8.1 Expert Opinion

The use of expert opinion in decision analysis has been around for a long time. The benefits of such a tool in decision analysis and policy development are capable of transforming the risk quantification process of risk management. In fact, expert opinion is an extremely useful tool in risk assessment if employed and used cautiously. This type of approach to risk quantification is even more pertinent when data relevant for assessing the elements of risk are not available, limited, or scarce. For example, when one is starting to manage the risk of failure for a category of transportation infrastructure that does not have any inventory or condition data, the best approach is to start by soliciting expert opinion on the conditions, probability, and consequences of failure until such data has been fully collected as the process matures.

Until complete and quality data becomes available, experts' preferences are the only source of quantifying or assessing these variables (Hubbard, 2010). One set-back to this approach is that the information one gathers from the experts are usually agency specific. As such, using this data in different geographic regions will require additional efforts to validate the opinions with the experts in the particular organization of interest. In gathering expert opinion, practitioners can choose from a diverse number of methods depending on some known influencing factors, such as accessibility of experts, time, and monetary resources. Examples of opinion gathering techniques include brainstorming, risk workshops, or the Delphi method (see Chapter 4).

2.8.2 Risk Matrix

Risk matrices have become one of the most widely used tools in risk quantification, especially, when decision makers are dealing with qualitative or semi-quantitative data. This method of risk assessment has become common with risk analysts in the information technology,

infrastructure management, and natural disaster management fields. The common form of a risk matrix is a two-dimensional figure that combines these two dimensions to categorize each risk event. Typically, the probability and consequences of occurrence of the risk event under consideration make up the dimensions of the matrix. Recent practice, however, has seen an evolution of the risk matrix into a multi-dimensional (i.e., more than two dimensions) figure, as decision makers continue to consider other facets of risk events. Figure 2.15 and Figure 2.16 illustrate two typical structures of risk matrices.

The use of nominal and ordinal categorization and risk matrix in risk estimation is very straightforward and simple making it increasingly attractive to risk analysts and modelers. However, the risk matrix's penetration into the risk field comes with many criticisms from risk practitioners. While some critique the risk matrix approach to risk quantification as fallacious, others believe that its shortcomings are compensated for by its simplicity. It is important for analysts to note that the strength of a risk matrix is only for comparative ranking. That is, the risk matrix alone cannot offer decision makers enough information about a risk event except by indicating which risk event is really bad and which one is less so. Making an informed-decision will require more information the risk matrix provides. Information such as the causes of the risk event and the current mitigation actions in place at the organization will help decision makers to better understand the problem and make better and practical decisions.

Likelihood	Consequence				
	Low	Medium	Moderate	High	Extreme
Extreme	M	H	H	E	E
High	M	M	H	H	E
Moderate	L	M	M	H	E
Medium	L	M	M	M	H
Low	L	L	M	M	H

Figure 2.15 A Two-dimensional Risk Matrix

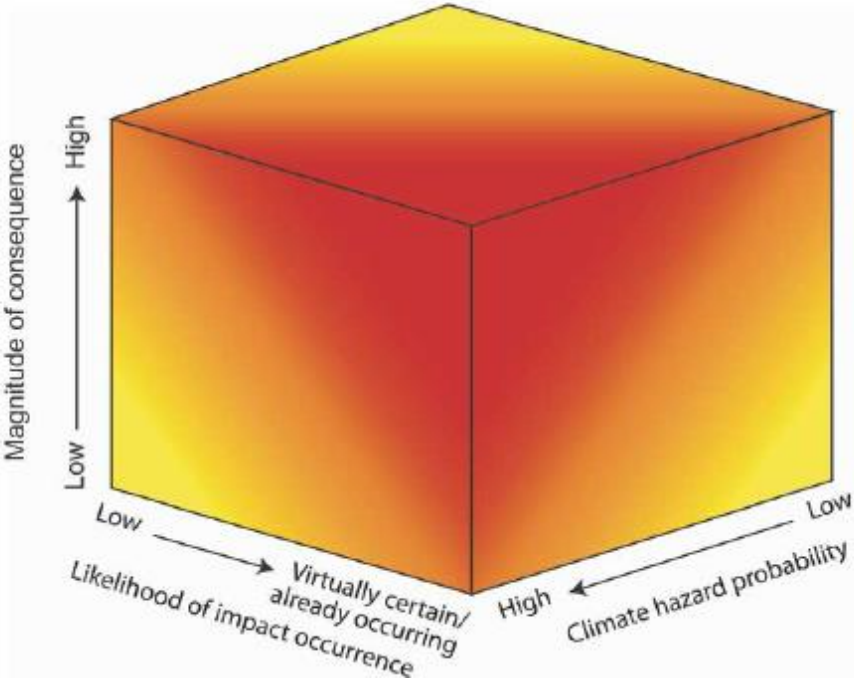

Figure 2.16 A Multi-dimensional Risk Matrix (Major & O'Grady, 2010)

2.9 Evolution of Department of Homeland Security Risk Assessment

After the 2001 terrorists attack in the United States, risk assessment and management to safeguard US interests against future attacks escalated to an unprecedented level. This change led to the reclassification of the Department of Homeland Security (DHS). The objectives of

DHS involve the identification of threats resulting from terrorists' attacks, assessment of risk, and communication of the information for decision making and resource allocation to cities. That is, information from the assessment process goes to inform the Homeland Security Grant Program (HSGP). The HSGP is a grant allocation program that provides funding assistance to state and local agencies to strengthen security within their jurisdictions. The duties of the DHS go beyond the prevention of terrorism to include natural disasters and pandemics. However, most of the Department's work is heavily directed towards terrorism [against cities and critical infrastructure]. In the early years of the DHS' risk assessment process, very limited data was available to risk analysts. Throughout the years though, the risk assessment methods of the DHS have evolved. Specifically, this process has gone through three main changes.

The first stage of the method basically characterizes risk as a function of population. The second stage of risk method involves three criteria; threat, criticality, and population density. The current methodology, which focuses mostly on critical infrastructure risks, classifies risk as a function of threat, vulnerability, and consequence. That is, the risk associated with the failure of a critical infrastructure is given as a product of the three criteria ($R = T * V * C$). Again, the most challenging aspect for DHS implementing these methodologies is the lack of historic data. However, these challenges are overcome by the use of other techniques, such as subject matter estimates (SME) (CRDHSA and NRC, 2010). Figure 2.17 shows a timeline evolution of DHS risk assessment methodologies.

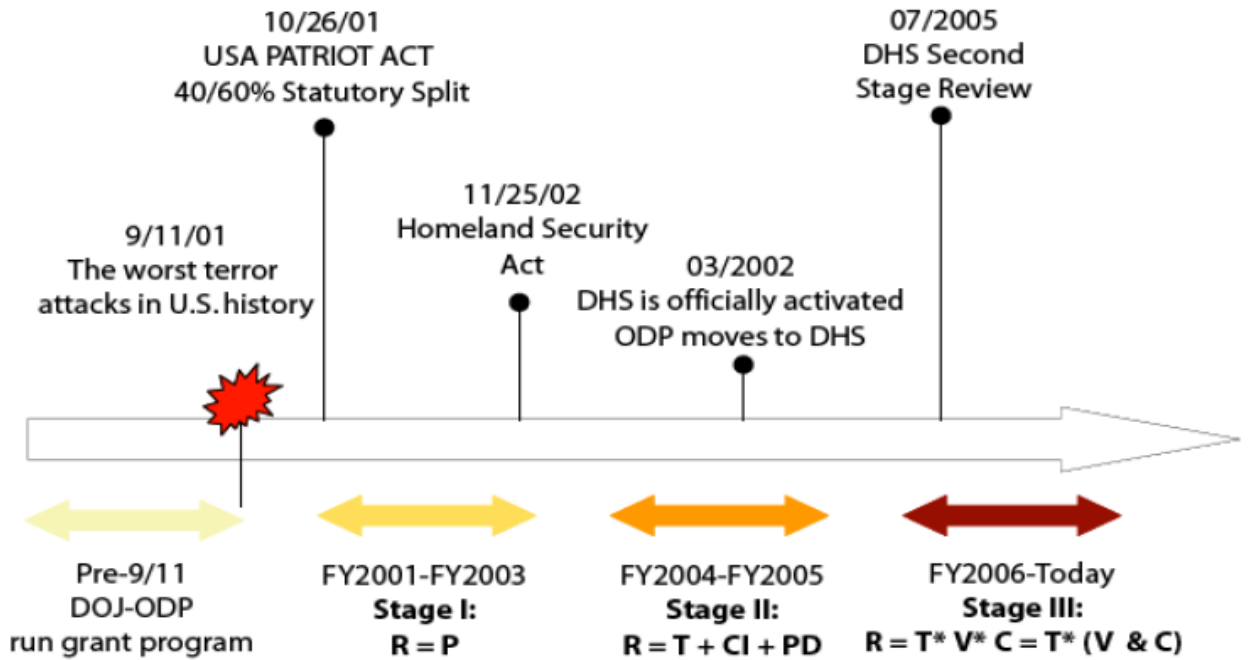

Figure 2.17 Timeline of DHS Risk Assessment Methodologies (CRDHSAs and NRC, 2010)

2.10 Application of Risk Management in Transportation Asset Management

In the literature, practitioners and researchers have applied risk concepts in managing and preserving transportation infrastructure. In fact, practitioners and researchers have applied risk in diverse ways pertaining to the management of the physical transportation infrastructure: in climate change adaptation and asset management (Meyer et al., 2009; Meyer et al., 2010). Largely, researchers have used these concepts in managing bridges and pavements. For example, Queensland, Australia assesses the risk (product of probability of failure and consequence of failure) posed by a bridge, using a model called Whichbridge. The model computes a numerical value for each bridge using variables such as the condition of the bridge components, environmental impacts, component materials, design standards, and traffic volume. The probability of failure is expressed as a function of such variables as loading, resistance, condition, inspection data, and exposure. Whichbridge computes a surrogate for consequence

using variables such as human factors, environmental, traffic access, economic, road significance, and industry. Using these variables, the system relatively ranks each asset on risk exposure and safety conditions. This implies that each asset's risk is not absolute, but relative to the other alternatives in the selection pool (FHWA, 2005).

Similarly, Perrone et al. (1998) developed a model that accounts for the variability in life cycle cost analysis of pavement projects, as a measure of risk for each project alternative (Perrone et al., 1998). In their paper, the authors discuss the development of life cycle cost analysis procedure that accounts for the variability in the input variables and their effects on the life cycle costs of pavement treatment alternatives. The authors argue that there exists some variability among the factors used for life cycle cost analysis. As such, using historical data and expert judgment, one can estimate a distribution for these factors over the life cycle of a pavement. Consequently, one can adopt these distributions as input variables for the analysis. Essentially, the risk of each alternative project is measured to be proportional to the standard deviation of the distribution of total life cycle cost. Effectively, a higher standard deviation corresponds to higher uncertainty about the actual cost value, and hence higher risk.

In addition, in the application of risk in transportation decision making, VanDyke et al. (2014) developed a model that estimates risk profiles for Georgia's Interstate Highway System. The developed approach employs condition and performance data on pavements and bridges and economic impact assessment for the Interstate to characterize risk. This two dimensional approach of risk estimation provides insight to Georgia Department of Transportation asset management decision making process. The authors focus on internal risks. These include risks that can be mitigated through proactive maintenance activities, and therefore known as performance risks. The condition priority part of the framework captures and communicates an

asset's vulnerability to performance failure. Each asset is assessed on a scale of 0 to 1, and higher scores are assigned higher priority. The economic dimension of the framework captures the consequences resulting from the failure of an asset. Each asset is assessed on a scale of 0 to 100. Higher scores indicate larger impact assets and assigned higher priority. A risk matrix is then used to combine these two risk dimensions to estimate an overall risk score for each asset. This approach allows GDOT to rank each asset on three preservation priority scales (i.e., low, medium, or high). The following paragraphs present some additional findings on risk applications in TAM as reported by Boadi (2011).

Furthermore, Li et al. (2009) also proposed an uncertainty-based methodology that incorporates certainty, risk, and uncertainty inherent in input factors such as highway agency cost, traffic growth rates, and discount rates used in the computation of highway project-level lifecycle benefit or cost. The methodology, therefore, addresses a limitation that existing project-level lifecycle cost analysis approaches encounter. The study found significant differences between scenarios with and without uncertainty considerations. As a result of the large data requirements, the application of the methodology could be limited to only state and large-scale local transportation agencies because of the amount and level of historical data they maintain.

Likewise, Dicedican and Haines' (2004) study on highway infrastructure develops a systematic risk-based asset management methodology to manage the maintenance of highway infrastructure systems. The decision-making methodology developed can enable the harmonization and coordination of actions of different units and levels in a hierarchical organization. The framework uses a multiobjective decision tree for analysis to validate the tradeoffs between long-and short-term costs, applying the concept of remaining life to

distinguish actions in the present from those in the future. The systemic methodology also enables organizations to prioritize assets for maintenance while addressing the potential for extreme events. The costs, benefits, and risks of maintenance and inspection policies are balanced by the methodology and applied to the various types of assets. The methodology suggested by this paper adopts three objective functions in the options and strategies evaluation process: minimizing short-term cost, minimizing long-term cost, and maximizing the remaining service life of highway assets. The researchers used a constraint function, which enables the method to eliminate infeasible options by coordinating the remaining service life across assets. The methodology is not only applicable to highway infrastructure systems, but it can also be applied to the management of large-scale dynamic systems that exhibit similar characteristics as those of highway systems.

In addition to these studies, Salgado et al. (2010) reviewed some approaches to developing a model based on expert opinion for critical infrastructure risks assessment and vulnerability analysis. The researchers addressed the challenges (i.e., obtaining estimates for the probabilities of the initiating events as well as obtaining values for the associated consequences) in performing quantitative risk assessment of very rare events by reviewing Dempster-Shafer and Fuzzy approaches to elicit expert opinions.

Furthermore, Parsons Brinckerhoff et al. (2009) developed the Highway Agency's Adaptation Framework Model (HAAF), which provides a seven-stage process that identifies activities that will be affected by a changing climate, determines associated risks and opportunities, and identifies preferred options for mitigating them. The researchers identified over 80 highway agency activities or vulnerabilities that may be affected by climate change. The study also found that over 60 percent of the risks associated with these vulnerabilities are

expected to be materially affected by current predicted levels of climate change within their relevant asset life or activity time horizon. Another finding of the study by Parsons Brinckerhoff et al. is that the risk appraisal enabled vulnerabilities to be prioritized for attention based upon several criteria including their potential to disrupt the operation of the strategic road network. Mainly, prior efforts in risk-based transportation asset management have been limited to bridges and pavements, as well as treated in silo systems.

Recently though, practitioners and researchers have been investigating and applying these risk concepts in resource allocation and utilization to manage and preserve other pertinent highway infrastructure and hazards, such as culverts, guardrails, signals, and unstable slope (rockfall and landslides) locations. The early work in this area has primarily focused on developing and establishing applicable risk frameworks capable of phasing in this infrastructure or hazards into an agency's systematic management system. For instance, Amekudzi et al. developed a risk-based cost-benefit framework to help asset managers make a business case to decision makers the need for a comprehensive asset management; i.e., to prioritize other assets for inclusion in formal asset management programs (Amekudzi et al., 2011).

Likewise, NCHRP report 08-36 (2014) provides guidance on the application of asset management to selected ancillary assets. This research provides DOTs with a classification hierarchy methodology to enable asset managers to prioritize ancillary highway assets and establish inventories and management systems for these assets. The authors report that there are no industry standards for asset management of ancillary assets. In addition, most DOTs managed their ancillary assets at the lowest maintainable unit. As such, there is very little integration of the management of these assets (Rose et al., 2014).

2.11 Overview of Federal Authorization Risk-based Asset Management

Requirement

The 2012 surface transportation bill (Map-21), over the long term, is going to impact the practices of transportation asset management in many diverse areas. In fact, the bill introduces some key programmatic structural changes, one of which is the National Highway Performance Program (NHPP), which requires State DOTs to have a risk-based asset management plan to monitor the performance of their NHS. The critical part of the bill is the penalty that comes with a failure to meet this provision. As part of these provisions, State DOTs are required to develop a risk-based asset management plan that at a minimum includes bridges and pavements, with clear objectives and measures that allow for performance gap identification, lifecycle cost and risk management analysis that will inform a DOT's financial plan and strategies. The provisions also recommend that DOTs include other highway assets beyond pavements and bridges. These requirements will undoubtedly require DOTs to develop practical, flexible, and effective risk assessment methods that will enable these required analyses. This situation, therefore, creates gaps that researchers will need to bridge.

2.12 Gap Analysis

Based on the existing literature and practices, one can conclude that there is progress and evolution in the application of risk management in TAM. However, there is lack of research in developing methods or tools that focus on an integrated approach to risk assessment in managing AHA and hazards. In fact, the review of the literature revealed a significant number of studies that show a vertical (i.e., within a group of assets) risk management process, and mostly limited to the management of bridges and pavements with a few studies involving AHA. Indeed, very little research was found in which risk management was employed as a horizontal (i.e., across

different asset classes) decision-support framework for asset prioritization. In essence, the literature review revealed a degree of risk management application in transportation asset management. However, most of the studies focused on asset specific risk analysis and treatment, rather than an integrated corridor-level risk-based decision making. Hence, novel approaches are required to bridge this gap and provide decision makers with decision-support tools that enable them to make a better use of the limited resources, preserve these assets, and improve system performance, while mitigating imminent risks. Table 2.3 presents additional gaps that MAP-21 presents and the way this research proposes to address the identified gaps.

Table 2.3 MAP-21 Gaps and Research Remedies

MAP-21 Requirement	Shortcoming/Gap	Research Remedy
Develop performance- and risk-based planning for NHS: Only requires bridge and pavement infrastructure and recommends other infrastructure	Provides no directions or guiding procedures in selecting which other assets to include	Provides a risk-based systematic approach within the context of an agency to identify other high-risk assets
Establish separate targets for each management system	Encourages silo-form of systems management: Ineffective and inefficient approach	Provides an integrated framework that allows asset managers to consider and monitor the performance of their NHS in an integrated manner.

Chapter 3 CORRIDOR-LEVEL ASSET-SYSTEMS MANAGEMENT

3.1 Hierarchy of Transportation System Planning

Federal, State, local, and private organizations that own large, complex, and geographically distributed infrastructure systems are always investigating efficient and effective ways to manage their assets. The common practice has involved localized and standalone strategies in managing different asset categories. That is, most management activities have focused on individual management of different asset categories through stand-alone systems management. However, since these assets do not operate in isolation, this management practice (silo, stovepipe, or standalone systems management) becomes practically inefficient to strategize and allocate resources without considering integrated system management (ISM).

ISM or planning enables an organization to holistically and comprehensively preserve infrastructure conditions as well as meet and improve both agency goals and customer expectations. ISM applied in asset management planning reinforces integrated management practices, improves interagency sharing of information, and facilitates better communication of risk. An integrated system-level approach to asset management provides a robust planning framework for decision makers. Moreover, it allows decision makers to identify high-risk locations, highly vulnerable asset categories, and strategically prioritize and budget for projects or programs to mitigate inherent variability and risks.

In practice, one can identify a hierarchy in transportation system planning. Typically, there are four levels in this hierarchy of system management in transportation planning. Figure 3.1 shows the levels and capacity at each level. Network-level planning constitutes the highest level of transportation planning. A surface transportation network is a collection of

interconnected streets, railways, transit lines, and pedestrian or bicycle infrastructure, or any structure that enables the movement of people and goods. In network-level planning, transportation planning organizations (i.e., State, county, city DOTs, etc.) consider all routes (single or multi-modes) that provide inter-connected pathways between multiple locations.

The next level at which transportation planning occurs is at the corridor level. “A corridor is a defined section of the transportation pathway (right-of-way) that traverses and crosses natural and manufactured obstacles and provides for economic vitality by allowing for the safe and efficient movement of people and goods” (Anderson & Rivers, 2013). At the corridor-level of systems management, a planning organization only considers parallel, possible competing routes (and modes if applicable) between locations, such as intersections, mile posts, monuments, or cities. Similarly, route-level planning considers a single physical infrastructure pathway (e.g., highway, transit route, or bicycle route) that connects two defined locations or destinations. Finally, project-level planning, which is the lowest level in transportation systems planning only deals with discrete initiatives that are geographically localized to an area (ATC, 2006). At each planning level, opportunities exist for decision makers to undertake ISM. That is, at each planning level, decision makers can aim for a more comprehensive approach to asset management.

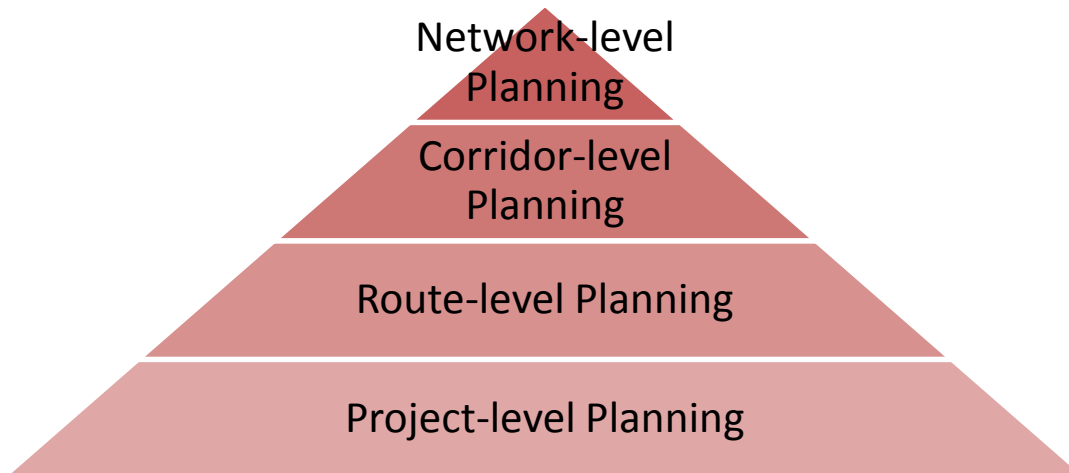

Figure 3.1 Transportation Systems Planning Hierarchy

Corridor-level treatment of a transportation system is not a new concept among transportation practitioners and decision makers. In fact, in traffic management and operations, analysts have benefited from programming signals in a coordinated format to benefit an entire corridor. Knowing that an underperforming signal, intersection, or link within a corridor can deteriorate the entire performance of a corridor, independent of how well all the other signals perform, traffic operations managers and analysts have successfully integrated corridor operations activities to implement integrated corridor-level traffic operations (Yang & Yagar, 1994).

Acknowledging that the reliability of traffic operations within a corridor is as strong as the weakest activity in the corridor, it is imperative that decision makers and analysts take a holistic and comprehensive approach in managing all systems, operational activities, or operational features that affect the performance of a transportation route, corridor, or network. In fact, transportation agencies and researchers are investigating integrated systems (i.e., multi-modal integration) management at the corridor level in several places throughout the country

(Krule, 2012). Often, these efforts are targeted at reducing congestion, improving the movement of goods and services (i.e., considering multi-modal systems), and improving air quality.

Similarly, in TAM, the performance of a road segment/route, corridor, or network is as reliable as the failure rate of the most vulnerable infrastructure or the probability of occurrence of the most imminent hazard. As such, ensuring that all critical infrastructure or imminent hazards are considered in management procedures over a given corridor can help decision makers identify corridors that are highly vulnerable to failure, through the identification of these vulnerable categories of assets and imminent hazards. Integrating these critical asset categories and potential hazards in corridor management offers better coordination of decisions horizontally and vertically across an agency. This practice is known as an integrated corridor management (ICM). In fact, ICM also creates opportunities for decision makers to target limited resources to areas of the highway network that really need improvement to mitigate or eliminate agency liabilities. Essentially, corridor-level strategies help to achieve specific system and agency objectives, identify performance levels—i.e., current and anticipated—system challenges, and mitigation strategies to alleviate extreme consequences.

3.2 Reliable Transportation Network

DOTs (Federal, State, and county) and decision makers are responsible for delivering a safe, efficient, effective, accessible, and reliable transportation network to their customers or network users. A reliable transportation network can be defined as one that is able to meet its goals without unexpected loss, or little loss in operational efficiency. Essentially, a reliable transportation network is fundamental to the economic competitiveness of a nation, region, or community. In addition, local governments and agencies rely on the performance of their transportation networks to improve the quality of life of their citizens. Indeed, a reliable

transportation network encourages economic development and growth as well as reduces the risks (e.g., safety and mobility risks) associated with the failure of a network. Ensuring such reliability requires that decision makers consider the synergistic effects among constituents of the network as a whole.

For a transportation network that experiences a continual growth in demand while the majority of the infrastructure is approaching, has reached, or exceeded its service life, it is imperative that decision makers work towards minimizing the rate of network failures targeting highly vulnerable assets and highly critical corridors. Providing a reliable transportation network means decision makers ensure that a transportation network performs at an acceptable minimum LOS. This practice also means that enough redundancy is built into the transportation network to ensure that minimal failure points exist within the network to improve network resiliency; that is, to ensure that detour routes are functional to reduce total network breakdown. The availability of these redundant routes provides the transportation network with an inherent ability to compensate for corridor failures. Achieving this task basically requires a better understanding of the network, which means gathering additional and quality data on network components or infrastructure. These practices offer good information for a risk assessment process.

Arguably, it is not practical or affordable to build a 100 percent reliable, or zero-risk transportation network. However, decision makers can define practical and acceptable reliability levels that are cost effective with positive return on investment (Fischhoff et al., 1980). Studies show that an increasing number of agencies are currently gathering complete data on the networks they manage (Hawkins & Smadi, 2013). However, not all of this data is used as part of agencies' resource allocation decision-making process. Most often, the data is for inventory purposes. On the other hand, making an informed decision requires more than just inventory

data. Accordingly, decision makers can make conscious decisions to improve their data gathering practices. This initiative, if undertaken properly, will aid in improving the reliability of the transportation network as well as enabling decision makers to gain the trust and confidence of taxpayers and network users. Finally, in dealing with network reliability, there are many factors that decision makers can consider. For example, the number of elements that go into the definition of transportation network reliability depends on the objectives and goals of a DOT. For instance, one may be interested in reliable flow of trucks in freight corridors because the agency may be interested in economic growth. On the other hand, one may rather be interested in asset preservation, in which case the focus will be on ensuring that the entire infrastructure performs at or above a minimum LOS.

3.3 Corridor-level Performance Assessment

In corridor-level performance assessment, the focus is on the performance of respective corridors as a function of asset classes and hazards (management systems/threats) that exist on these corridors or the program types an agency maintains as part of their strategic management process (i.e., safety, mobility, or asset preservation programs). Particularly, a major consideration in corridor performance assessment includes gathering quality quantitative condition data on infrastructure and the frequency of hazard occurrence data as well as operational performance data on programs. Effectively, decision makers can define the reliability of a corridor based on the performance (conditions of physical infrastructure and hazards and operational performance of programs) of the corridor.

For example, one can say that a corridor is highly reliable if none of the components (management systems or programs) of the corridor falls below a minimum performance level over a defined period of time. That is, one is certain, using models or technical knowledge that a

corridor will perform well in the future. Figure 3.2 illustrates the three levels at which one can assess the performance of a corridor. Program-level corridor assessment is implemented using all or critical strategic management programs, such as safety, mobility, air quality, congestion mitigation, asset preservation, etc., in assessing the performance of a corridor. Specifically, program-level assessment involves the use of different management systems to assess the performance of a corridor. Similarly, at the system level of corridor assessment, decision makers assess the performance of a corridor based on respective asset or hazard systems (e.g., culvert, unstable slopes, or guardrail management systems). Finally, for a project-level corridor assessment, decision makers consider projects from respective management systems that fall within a corridor. The ability of these projects to meet their respective systems' goals offers an indication of the level of performance of the study corridor.

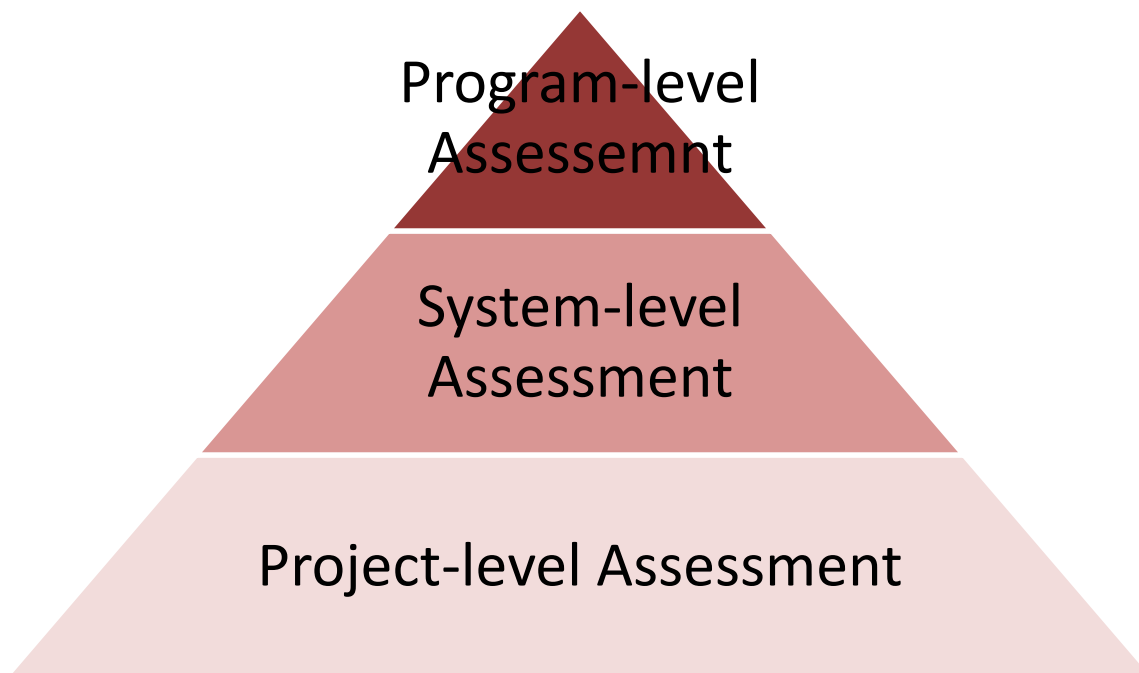

Figure 3.2 Corridor-level Performance Assessment Hierarchy

Primarily, performance measures allow decision makers to quantify the consequences of their decisions. In fact, the performance level of a corridor gives a measure of accomplishment relative to an agency's objectives and goals. Performance measures are applicable to all levels of transportation decision making: enterprise, network, corridor, route, and project. Consequently, decision makers can rely on performance measures in corridor-level planning to identify alternatives for further analysis (risk analysis) or prioritization. Corridor-level performance measures in asset management can encompass wider measures (program-level decision making) and core measures (system-level decision making) that reflect economic, social, or environmental issues. For example, one can assess the performance of a corridor on respective systems (i.e., system-level decision making) or among systems (i.e., program-level decision making): safety, congestion, accessibility, or asset preservation. Ultimately, decision makers can evaluate the performance of a corridor at different levels. Decision makers can develop measures to assess all these areas of performance. In asset preservation, examples of corridor measures may include, but are not limited to, slope stability, structural deficiency of culverts, pavement roughness, etc. Considering all these facets of performance and associated uncertainty allows decision makers to identify plausible alternatives, plan appropriate budgets, and hence reduce their liability for risks.

Generally, corridors have different functional characteristics (i.e., Interstate highway, non-Interstate highway, NHS, or arterial) and, therefore, it is possible for decision makers to assess corridor performance based on different standards. The functional importance of a corridor will define the level of assessment applicable. That is, a rural corridor will not have the same level of priority as an urban corridor. Primarily, performance measures may vary between urban and rural areas or Interstate and non-Interstate highways. For example, consider two

corridors A and B. If corridor A serves a high percentage of truck volume traffic and it is an essential link to a commercial or industry area, decision makers will expect such a corridor to perform highly or efficiently when assessed on economic performance than route B, which has only few truck traffic and only serves rural traffic. Fundamentally, high-priority corridors are expected to perform relatively better than low-priority corridors. By asserting individual levels of performance measures for corridors of different or similar characteristics, decision makers are able to identify and gain insight to locations that will yield relatively better returns if resources are invested. Ultimately, the performance assessment process an agency adopts must align with the goals and objectives of the organization.

3.4 System-of-Systems (SoS) Approach

“A system-of-systems is a set or arrangement of interdependent systems that are related or connected to provide a given capability. The loss of any part of the system will degrade the performance or capabilities of the whole” (CJCSM, 2004). A transportation network is an example of a SoS. Typically, as Figure 3.3 illustrates, a transportation network may consist of subsystems such as bridges, roadway pavement, traffic signals, and other supporting systems such as guardrail, pavement markings, signs, retaining walls, and culverts. Although these individual systems serve particular purposes, a reduction in performance or loss of one subsystem can adversely impact the ultimate performance of the entire transportation network. Typically, DOTs maintain separate (silo) management systems for each subsystem. In other words, the performance of a transportation network depends on how well the individual subsystems perform. Primarily, unmanaged subsystem component failures are the likely risk sources. Particularly, as the condition of assets deteriorates due to usage and aging, with no proper management or rehabilitation strategies, performance deteriorates, failure rates increase,

and reliability decreases. Reversing these negative impacts, therefore, requires decision makers to choose strategies pertaining to an SoS framework.

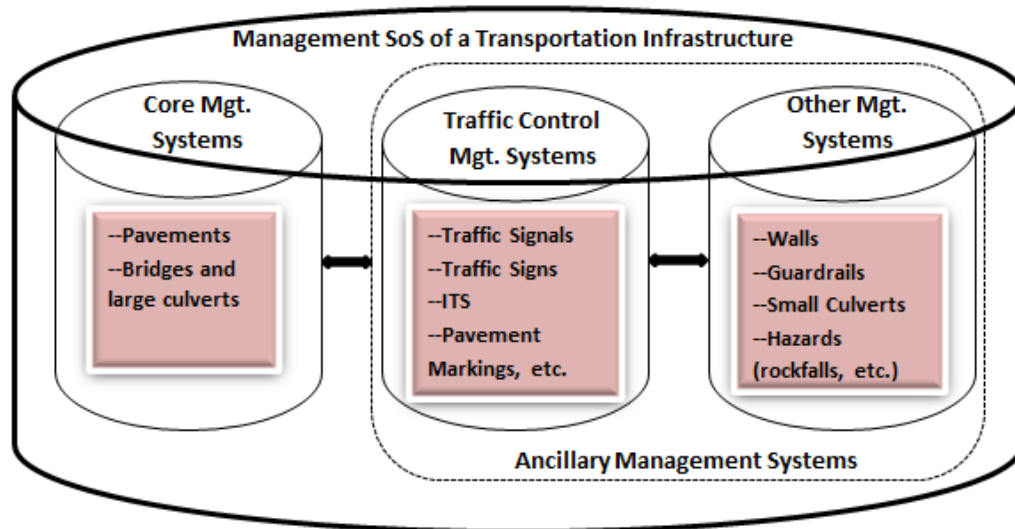

Figure 3.3 System-of-systems Tools for Transportation Infrastructure Management Systems

One can describe a transportation network as a chain consisting of separate links. Each link represents a corridor or segment of roadway and the strength of each link represents the collective effect or performance of all the programs within the corridor. However, the programs include major subsystems, pavements and bridges, which are the core components of each link. As such, one can conclude that a transportation network with well-performing pavements and bridges can offer an acceptable reliable service to its users. Fortunately, most often, these subsystems are not arranged in a series format. Accordingly, a failure in one subsystem does not result in automatic failure of an entire segment, link, corridor, or network. For instance, consider a transportation network with excellent pavement conditions but poor-conditioned guardrail along hilly regions. Although one can assert that the network performs very well with respect to

pavement condition, the safety risks that exist within the network provide setbacks with respect to the safety objective or goal of the agency. Accordingly, an ICM or SoS approach to a risk-based asset management is one approach decision makers can use to effectively and efficiently distribute limited resources among programs, systems, or projects.

Largely, this approach allows decision makers to consider all critical sub management systems in their asset management plan. In addition, an integrated SoS approach to asset management facilitates coordinated maintenance procedures, which reduce system interruptions due to scheduled maintenance. For agencies to efficiently utilize their limited resources, improve their planning efforts as well as optimize the performance of their systems, a SoS view of management systems is an effective way forward. However, this approach should not be seen as a replacement to subsystem, standalone, or silo management; rather these approaches should complement one other to enhance the risk management plan of an organization. That is, both horizontal and vertical systems management are equally important. Indeed, an SoS approach in management helps in identifying, quantifying, and evaluating risks, uncertainties, and variability within the decision-making process (Haines, 2009). Although this approach offers great benefits, the lack of good data on some of these subsystems can be discouraging. As such, decision makers, practitioners, and analysts can make use of expert opinion and understand this process is not static but should evolve over time as individual subsystems mature and the overall level of integration increases, as additional data becomes available.

The level of system integration or SoS management depends on diverse factors: resources limitation, criticality of asset category to agency goals and objectives, or return on investment the asset category offers. Due to varying agency size, difference in fundamental goals and objectives, and geographical disparity, decision makers may choose to treat each subsystem with

a different level of criticality. In fact, it is possible to find different regions within an agency, typically larger agencies, that may treat different categories of assets with different levels of priority. For example, consider a DOT with different geographic characteristics. That is, one region or district may be dealing with roads along the mountains and will, therefore, be interested in ensuring that rockfall or landslide locations are stable, or the integrity of all guardrails along these corridors are high. On the other hand, another region or district may be battling with roadway flooding during rainy season, and so will be interested in improving the flow performance of their culverts. In effect, as an agency considers an SoS management approach, it is important that they contextualize the approach in different geopolitical regions as not all regions or districts within the agency may have the same challenges.

3.5 Challenges in Implementing SoS Management

Although an SoS approach to asset management offers unlimited benefits, there also arise common challenges that may include both technical intricacy and business procedures. A variety of challenges may arise as agencies make efforts to implement a SoS risk analysis or management. In fact, as an agency moves towards a SoS risk management, data integration will be one procedure vital to the success of this management style. The *Data Integration Primer* defines data integration as “the method by which multiple data sets from a variety of sources can be combined or linked to provide a more unified picture of what the data means and how they can be applied to solve problems and make informed decisions that relate to the stewardship of transportation infrastructure assets” (OAM, et al., 1999). Accomplishing complete or useful data integration involves a myriad of challenges one needs to overcome. These challenges, as stated earlier, can be cultural and/or technical. The *Data Integration Primer* outlines a few familiar challenges as well as strategies to address these challenges. Addressing these issues during the

early stages of the process can offer many incentives in the long term. Currently, since most of the transportation subsystems are managed in the silo form, it is possible to find different categories of asset systems housed with different database systems that are built in-house or purchased from different systems developers.

This common practice has led to a lack of uniformity among the systems currently available in DOTs. Some of these standalone database systems may be incompatible with each other. Others may as well be outdated technologies that do not meet the expanding needs of modern technology. Addressing this challenge and moving towards a compatible future will require decision makers to make several adjustments in building future database systems. For one, decision makers, analysts, and asset managers can build responsive database systems. These systems support existing applications while remaining responsive to future changes. Adopting this strategy will increase an agency's long-term enterprise productivity. As agencies invest in gathering data, they must make effective use of the data resources available. In fact, Matheus et al., (1993), observed that organizational data is still largely unrecognized, inaccessible, and underutilized. Therefore, systems managers can develop strategic data modeling and enterprise database designs that offer analysts the capacity to manage and utilize available data.

Moreover, since SoS risk analysis involves experts with different backgrounds, there is the propensity to have different perspectives in defining system objectives, concerns, and expert preferences. Although perspectives can be equally valid, the resulting competing and conflicting views can influence the selection of model variables, problem formulation, and preference setting. Generally, these challenges may seem to be a setback. However, experts' different perspectives about a system ultimately allow modelers to develop different models of the same

system, resulting in a more robust characterization of the system. Hartfield and Hipel observed that, by explicitly stating the differences between assumptions influencing models, these models can help stakeholders uncover and resolve any controversy (Hatfield & Hipel, 2002).

Eventually, this exercise enables decision makers to make informed decisions concerning a system.

3.6 Spatial Analysis and Corridor-level or Integrated Asset Management

Spatial analysis provides a set of techniques for analyzing spatial data. The results of spatial analysis are dependent on the relative locations of the objects being analyzed. Software that implements spatial analysis techniques requires access to both the locations of objects and their attributes. In corridor-level planning or integrated asset management, location identification is very critical. The ability of analysts to align all categories of asset within a corridor enhances their ability to assess the performance of the corridor in its entirety. A Geographic Information System, GIS, is a typical spatial analysis tool employed in asset management that allows decision makers to spatially analyze data and visualize them concurrently. Tools, such as ArcView GIS, offer decision makers and analysts a unique opportunity to undertake corridor-level planning or integrated asset management with more efficient and effective data collection, analysis, and alternative evaluation. The ability of analysts to present visualized data allows them to communicate easily and effectively with decision makers. Further, spatial analyses allow analysts to perform quick spatial or attribute selection for further investigation. Analysts can also use spatial analysis to determine correlations among factors, such as route locations and risk levels, or route vulnerability and geographic locations.

Admittedly, GIS can play a functional role in decision making related to corridor-level planning or integrated asset management (Goodchild, 1987; Grimshaw, 1994). Current DOTs

approach to data collection involves the use of GIS applications. However, since there are no current standards in the collection of data, a variety of datasets with varying attributes currently exists. The completeness of a geographic database of assets complements a corridor-level planning or analysis. As such, decision makers or asset managers can perceive the need to develop appropriate databases that enhance spatial analysis as an incentive to developing an integrated asset management framework. Spatial analyses offer decision makers the ability to evaluate alternatives considering multiple criteria that may not necessarily be built into systematic algorithms. For instance, visualizing the proximity of scheduled projects or programs to each other can enable decision makers to schedule these projects or programs simultaneously to limit network interruptions due to road closures for maintenance or rehabilitation purposes.

Ultimately, spatially enabled datasets can support data analysis based on geographic location, such as representing data on maps in various spatial or geographic contexts, and determining proximity, adjacency, and other location-based relationships among infrastructure, corridors, and regions. For example, decision makers are able to visually ascertain the distribution of problem areas—high risk locations, geographic regions with vast numbers of vulnerable corridors or asset classes—and prioritize projects or programs accordingly. In addition, spatial analysis in corridor-level planning helps in dealing with the problem of equity -- that is, selecting projects and distributing resources such that certain regions are not at a disadvantage. Visualizing assets, routes, corridors, and regional boundaries in a single view offers decision makers a broader view to manage the diverse demographic patterns within their jurisdictions and prioritize projects accordingly to address resources distribution equity.

Finally, as mentioned earlier, corridor-level asset management planning must be supported with spatial analysis. As such, the need arises for analysts and decision makers to

have access to complete spatial data. It is, therefore, imperative that asset managers develop spatial data-collection strategies, in conjunction with condition data, for each sub-category of assets that is critical to the objectives and goals of the concerned organization. By combining spatial analysis with SoS corridor-level asset management practices, decision makers will be able to efficiently utilize limited resources as well as reduce inherent risks. In fact, knowing the relative spatial relationships among assets, routes, and corridors improves risk decision making, from coordinated maintenance and repair activities, toward the elimination of impending risks, to reduced system interruption. Without a doubt, spatial analysis in asset management is not a new concept; however, combining the capabilities of spatial analysis with SoS corridor-level management offers a new form of value to asset managers, analysts, and decision makers in evaluating and selecting alternatives that reduce the risk of an agency as well as offer better returns on investment.

3.7 Selecting Alternatives

The process of selecting alternatives has been an old-age challenge that decision makers have been dealing with in resource allocation and utilization. This problem is even exacerbated in the wake of the dwindling and uncertain funding environment. Likewise, in transportation decision making, this is not a new challenge for decision makers. So it is common for transportation decision makers and practitioners to evaluate and select optimal alternative(s). The selection of alternatives becomes even more complicated when a large number of stakeholders with multiple objectives are involved in the decision process. These challenges, therefore, require logical guidelines in making a selection. Consequently, it is important to ensure that these logical guiding principles are in accordance with an agency's needs, goals, and objectives.

In the case of selecting alternatives, decision makers and analysts use qualitative, quantitative, and semi-quantitative methods in achieving their goals. These methods cover both heuristics and operations research methodologies. The mathematical complexity of some of these methods may sometimes require specific expertise from analysts and practitioners. Most often, DOTs and decision makers will want to avoid these complexities and rely on simpler methods in the decision process. As such, this dissertation provides a user-friendly decision framework and methodology that decision makers can employ in their alternative selection process. Chapter four outlines the proposed framework and the necessary supporting models.

Chapter 4 CONCEPTUAL FRAMEWORK AND METHODOLOGY

The conceptual framework and methodological approach presented in this chapter form the basis for the analysis used in the case study implementation. In chapter 2, this dissertation discussed the types and formats of risk frameworks decision makers and analysts employ in their risk assessment and management practices. The framework developed in this work follows similar principles of generic risk frameworks but moves beyond these to provide a platform for integrating non-homogeneous assets and hazards in a risk assessment. The purpose of this framework (Highway Assets Risk Management) is to provide a guiding approach within which decision makers can assess risk and systematically integrate risk information into their decision-making process. The Highway Assets Risk Management (HARM) framework offers decision makers and analysts a practical approach to individually and collectively 1) assess risk consequences and impact of asset conditions, 2) assess vulnerability of asset or corridor to failure, and 3) develop practical solutions to mitigate inherent risks. The HARM framework offers adequate flexibility that allows practitioners to tackle a diversity of problems by replicating the HARM process using preferences that may be specific to the challenges practitioners face.

4.1 Proposed Framework

Previous risk frameworks for TAM have been limited to individual categories of asset classes (i.e., asset-level management, or silo-approach); specifically bridges and pavements. Currently, researchers are developing route-, corridor-, and network-level frameworks to address transportation infrastructure risk. Other areas such as climate change impact on transportation infrastructure have also seen the development of adaptive risk frameworks at the network level. Adaptive risk frameworks that focus at the asset level generally result in suboptimal risk

information to decision makers resulting in suboptimal decisions. Developing a framework that systematically incorporates different categories of infrastructure and assesses and prioritizes risk on a corridor level will enable decision makers to make improved decisions, perform tradeoff analysis, and optimize the performance of their transportation systems.

This dissertation draws from the experiences garnered from prior work on risk in asset management and develops an integrated risk framework that offers decision makers the flexibility to undertake both individual and collective risk analysis of their asset categories and assess their impact on corridor performance and agency's strategic goals. As illustrated in Figure 2.14, within the risk management framework lies the risk assessment phase. Completing the risk assessment phase requires systematic guiding principles. As such, this dissertation provides a systematic flow diagram as a guiding framework. Figure 4.1 illustrates the proposed Multi-Criteria Decision Analysis (MCDA) and risk assessment framework referred to in this dissertation as the Highway Assets Risk Management Decision Support System (HARM-DSS). The framework is divided into two successive phases: 1) asset category priority assessment and 2) corridor-level risk assessment and prioritization.

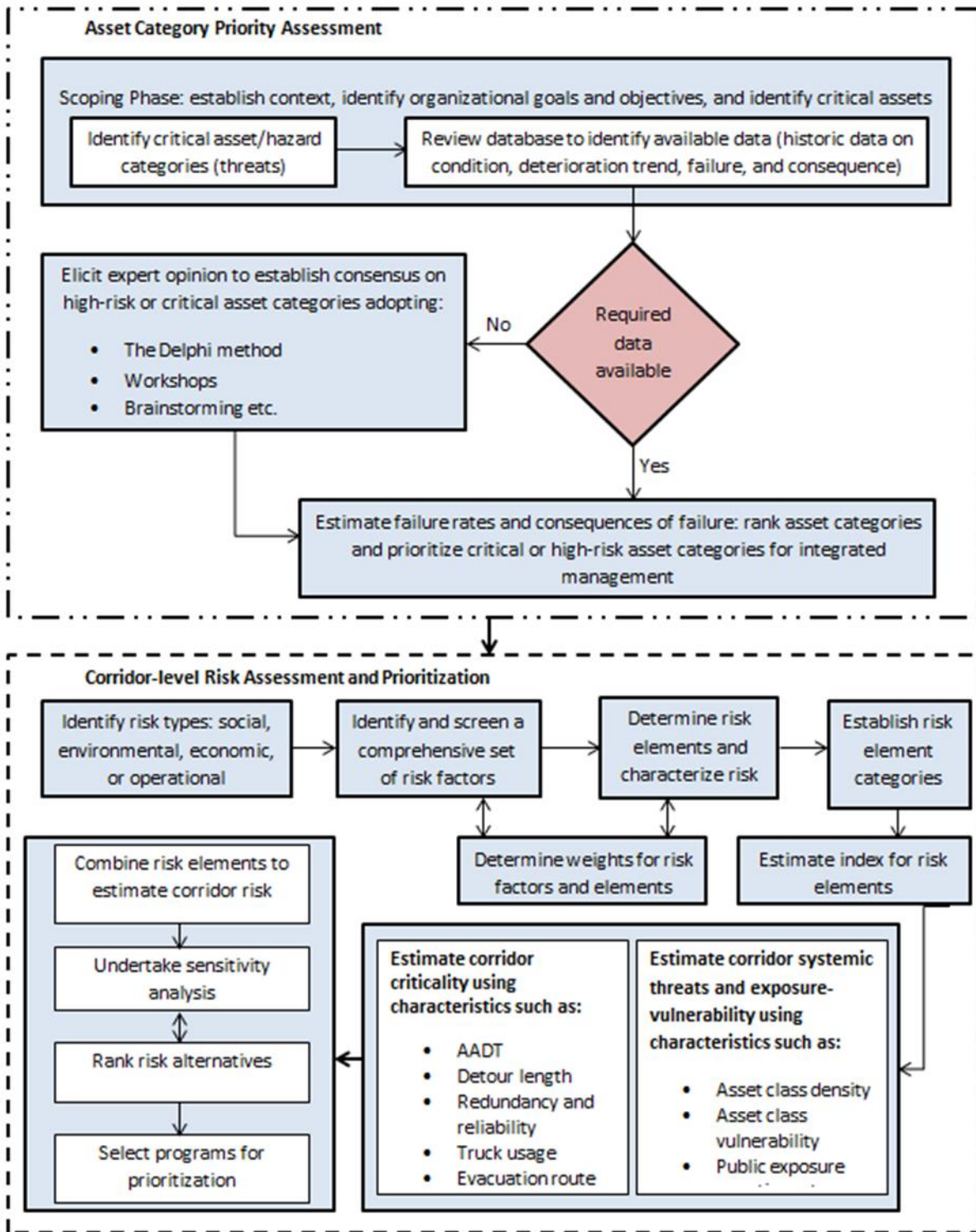

Figure 4.1 HARM-DSS Framework

4.1.1 Asset Category Priority Assessment

The asset category priority assessment phase of the framework involves the process of identifying the asset categories or hazards an agency considers critical or at risk. As such, the number, and type of asset categories or hazards can vary from one agency to the other, due to organizational goals, objectives, and even resource availability. Similarly, they can vary within the same agency from one region or district to another. The process starts with the establishment of context, identification of goals and objectives, and the definition of risk or criticality assessment procedures. During this process, an agency first undertakes a self-assessment of their asset management practices and identifies the types of asset data, failure data, and failure consequence and impact data that exist. Based on the existence of this data, a transportation organization can identify which asset category or hazard is highly susceptible to impact (negatively or positively) the performance of the transportation network and so the agency's goals and objectives. With such information, decision makers can then develop proactive policies to integrate these asset categories or hazards into a systematic framework for corridor-level asset management.

Often, during the risk estimation process in this phase, required data may not be available to undertake a quantitative estimation of the elements that characterize risk. Certainly, quantitative analyses usually possess a higher level of objectivity in decision making or analysis. Nonetheless, there are many important decision analyses that have benefited from the use of qualitative data. Qualitative data is used when no objective data exists or analysts cannot develop an objective index for a given attribute. In such situations, decision makers rely on subjective indices or scales developed by experts to evaluate decisions. For example, Huber et al. asserted that professionals can develop and reliably use subjective evaluation models to make

important decisions (Huber et al., 1969). For this reason, the framework provides decision makers or analysts with the flexibility of incorporating expert knowledge or judgment during this process. Although these inputs may seem imperfect and subjective, the decision process will evolve over time as more objective data becomes available.

The HARM-DSS framework suggests a number of elicitation methods that decision makers or analysts can employ to reach consensus on the behavior of asset categories, probable failure rates, and consequence or impacts of failure on agency goals and objectives. Undoubtedly, these techniques have advantages and disadvantages. Generally, it is a common practice to find organizations using qualitative assessment and developing quantitative capabilities as data become readily available. When an analyst uses qualitative expert judgment in an analysis, it is important to document and communicate the rationale behind the information to decision makers. Documenting such information helps decision makers to determine the level of confidence they place in their decisions based off this information. Ultimately, this process will enable decision makers and analysts to identify critical asset classes and hazards that will go into the corridor-level risk assessment and prioritization phase of the framework.

4.1.2 Corridor-level Risk Assessment and Prioritization

Following the initial screening and identification of an agency's critical asset categories and hazards, the corridor-level risk assessment and evaluation phase commences. This phase of the framework enables decision makers to undertake a holistic and comprehensive assessment of individual corridors that make up the transportation network. This assessment process is similar in steps to the processes in phase one. However, the second phase of the assessment process involves detailed valuation procedures. First, the agency has to identify the types of risk that are most critical or will have the most impact on the agency's goals and objectives. These risks may

fall under one of these categories: social, environmental, or economic. Second, one has to identify and screen a comprehensive set of risk factors that are good indicators of the criteria decision makers or analysts are considering in the multi-criteria analysis part of the assessment process. Subsequently, one has to establish how the risk will be measured, by determining the elements that will characterize risk. Many forms of risk characterization techniques are available in the risk literature. Each one has its own advantages and disadvantages and the circumstances under which one can employ them.

The HARM-DSS framework employs a two-dimensional risk characterization method. The two dimensions or elements are defined here as the corridor criticality and hazard exposure-vulnerability indices. Each dimension is estimated using a multi-criteria approach. Since each dimension may have a different impact on an agency's decision, one can develop weights for each of the risk elements. For example, a decision maker may be highly concerned about highly critical corridors and, therefore, will assign higher weights to the corridor criticality index, and vice versa. Another decision maker will be indifferent between the two risk elements and, therefore, will assign equal weights to the two risk elements. Similarly, one can develop weights for each of the risk evaluation criteria to indicate the level of importance of a criterion to a decision maker.

The number and type of criteria one employs in estimating the indices (i.e., corridor criticality and exposure-vulnerability) can vary among decision makers and agencies. Regardless, analysts and decision makers must ensure they do not under- or over-model the indices. That is, one has to be cautious in the selection of criteria. Generally, one should select criteria for a modeling process based on their applicability to choices between the existing alternatives. This process implies that analysts or decision makers can include new criteria or

drop old ones as new alternatives are considered or excluded. The process is essentially about establishing significant interaction between objectives and alternatives. As such, decision makers can undertake a thorough investigation and screening of criteria to develop robust criteria that capture multiple risks simultaneously. The final steps of the framework involve the combining of the risk elements to estimate the ultimate risk score of each corridor, performing sensitivity analysis, ranking of risk alternatives, and finally selecting programs for prioritization.

4.2 Proposed Method

Almost every management, policy, or business decision involves multiple elements. Similarly, transportation policies or management decisions can benefit from the consideration of multiple elements. In fact, due to the diverse goals and stakeholders involved in transportation investment decision making or planning, it is imperative that decision makers consider multi-criteria analysis in their decision processes. Acknowledging the importance of decision analysis involving transportation asset management, this dissertation proposes the use of an integrated multi-criteria decision analysis and risk analysis approach, adopting value functions, to systematically manage agencies' ancillary highway assets or hazards. The method integrates different risk criteria based on an additive weighting formula. The following sections discuss the concepts behind the methodology applied to estimate the elemental indices used in the risk characterization and estimation process. The MCDA concept is used to estimate the overall scores of the risk components (i.e., corridor criticality and exposure-vulnerability). To standardize the decision attributes of the risk problem used in the multi-criteria functions, constructed scales and the exponential value function were adopted.

4.2.1 Multi-criteria Decision Analysis

Decision analysis (DA) is a formal way of integrating philosophy, theory methodology, and professional practices that are relevant to a topic in making important decisions through a structured format. Keeney (1982) defines DA intuitively as “a formalization of common sense for decision problems which are too complex for informal use of common sense” and technically as “a philosophy articulated by a set of logical axioms, and a methodology and collection of systematic procedures, based upon those axioms, for responsibly analyzing the complexities inherent in decision problems.” Ultimately, a DA process guides a decision maker or an analyst to make decisions in a better structured and formal environment. An example of a DA method is the MCDA, which is one Operations Research tool decision makers or analysts frequently use when multiple stakeholders with competing and conflicting goals are involved in the DA process.

The goal of the MCDA process is to help decision makers evaluate different alternatives through a process of minimizing or maximizing certain preferences of stakeholders while achieving several objectives simultaneously. Due to the analytic capability of the MCDA, researchers, decision makers, and professional management journals have recognized its importance in decision-support application (Saaty, 1999). In fact, analysts and researchers are applying the concept in diverse engineering fields and other applications, such as environmental planning and management, forest management, and water regulation. Likewise, in infrastructure management decision analysis and decision making, multi-criteria decision making has emerged as a valuable tool. Consequently, researchers have developed and implemented a variety of MCDA tools in infrastructure management (Kabir et al., 2013, Boadi & Amekudzi, 2013).

Generally, two broad examples of MCDA techniques exist, under which individual tools can belong: multi-attribute utility analysis and multi-objective programming method. In multi-attribute utility analysis, a decision maker is explicitly aware of the set of available alternatives within which one selects the most preferred alternative. For example, one can evaluate the safety performance of alternative highway corridors by assessing available alternatives on elements such as the number of fatalities, number of serious accidents, or number of head-on collisions. Essentially, an analyst or a decision maker specifies a set of attributes that describes the value-relevant properties of outcomes, assesses single-attribute value functions over the levels of each attribute, and evaluates attribute weights that indicate the rate of substitution of value across attributes (Keeney & Raiffa, 1976). Conversely, in multi-objective programming, decision makers employ mathematical programming using objective functions. These mathematical algorithms enable a decision maker implicitly find a solution or alternative that is feasible within a decision maker's constraints as well as satisfy the objective function.

In decision analysis, analysts and decision makers have applied different methods of the multi-attribute utility theory to support decision making. Examples of these methods are the simple additive weighting (SAW), technique for order preference by similarity to ideal solution (TOPSIS), analytical hierarchy process (AHP), and the multiplicative utility method (MUM). Detail exploration of these methods is beyond the scope of this dissertation. For detail discussion of these and other MCDA techniques, see Figueira, et al., 2005. Fundamentally, each of these methods accomplishes the same goal except that they are different in approach. Admittedly, the SAW method is the most popular and widely used approach among policy makers and researchers because of its simplicity in computation and clarity in presenting

information. Accordingly, this dissertation employs the SAW method to combine the consequence, impact, and vulnerability attributes in characterizing risk.

Generally, the SAW problem can be formulated as follows: consider a decision maker having a finite set of alternatives (i.e., solutions or, in the context of this dissertation, finite set of corridors), say $C_i (i = 1, 2, \dots, n)$, for which the decision maker evaluates risk using a finite set of risk criteria, say $R_j (j = 1, 2, \dots, m)$, each representing the rating (consequence, vulnerability, or impact) on objectives, and $W_j (j = 1, 2, \dots, m)$ representing the relative importance of each risk criterion. The rating scale is computed using value functions or through the construction of scales for the attribute that represents the risk. The purpose of the SAW problem is to identify the alternative/corridor that contributes the most risk, consequence, or impact to agency's objectives or goals. As such, the alternative, C_i , that shows the highest disutility in Equation 4.1 with respect to all the risk criteria, is the most preferred alternative.

$$C_i = \sum_{j=1}^{n,m} W_j R_{ij} \quad (4.1)$$

Where

$C_i =$ overall score of the i th corridor

$W_j =$ relevance (weight) of the j th criterion

$R_{ij} =$ normalized rating of the i th corridor for the j th criterion

4.3 Criterion Weighting in Decision Analysis

In DA that involves multiple criteria or elements decision makers assign weights to individual criteria or elements to reflect the relative importance, criticality, or urgency one gives to a

criterion or an element. Criteria or elements with higher importance or criticality are assigned larger weights whereas relatively less important or critical criteria or elements receive lower weights. For example, decision makers considering two criteria—say safety and air quality—in their decision analysis process may choose to assign a larger weight to safety and a lower weight to air quality if they find safety to be higher priority for their system compared to air quality. Similarly, in multi-dimensional risk characterization, decision makers may be more critical about some components of the risk than others and will, therefore, assign weights accordingly to impact the overall risk score of alternatives. To illustrate this, consider that the risk of alternative solutions is characterized by three dimensions: vulnerability, exposure, and consequence. That is, the overall risk is an aggregate (for instance, using SAW) score of these components. However, if a decision maker is more concerned about reducing the consequence than reducing vulnerability, accordingly, the decision maker can propose to assign a higher weight to the consequence component. Consequently, most likely, the weight assignment will impact the overall risk score of the alternatives that result in higher consequences.

The process of assigning weights to individual criteria or elements in decision analysis can be challenging. However, the literature presents a number of techniques that are available to decision makers, analysts, and practitioners: ranking, direct weighting, pairwise comparison, and trade-off analysis methods (Shepard, 1964). In dealing with simple cases though, decision makers can accomplish this process by simply dividing and assigning the weights among the criteria or elements such that they sum to 1.0. This procedure uses expert judgment. In such a case, the assignment of weights can be based on heuristics or on specific preferences of decision makers and can be used to justify a priori preference. To illustrate this, assume that decision makers are dealing with n sets of criteria, they can assign weights as follows:

$$w = (w_1, w_2, w_3, \dots, \dots, w_n) \quad (4.2), \text{ and}$$

$$\sum w_i = 1 \quad (4.3).$$

4.4 Defining Decision Attributes

In transportation investment, decision makers are confronted with several alternatives as potential projects or programs. To make the most informed decision, decision makers evaluate the benefits, or in risk management, the risk reduction capabilities, of each alternative by defining a set of attributes (criteria) that reflect the performance of the factors (e.g., environmental, economic, or social) under consideration. Similarly, in corridor risk assessment, decision makers have to define attributes in assessing the risk each corridor poses to the objectives and goals of an agency. Currently, there are no standardized metrics available to assist decision makers or risk analysts. Nonetheless, in the literature, researchers discuss some desirable properties of a good attribute. Specifically, Keeney and Gregory specify five desirable properties of a good metric or attribute as: unambiguous, comprehensive, direct, operational, and understandable (Keeney & Gregory, 2005). Typically, these attributes should reflect:

- The criticality of the corridor to the operation of the transportation network
- The vulnerability of the corridor to failure with respect to the individual asset categories
- The economic and environmental characteristics of candidate corridors
- The geographic location of a corridor
- The emergency rehabilitation and recovery cost of corridor upon failure

The criticality of a corridor can impact the overall operation or performance of a transportation network. As such, identifying and improving the performance of each individual critical corridor can contribute positively to the overall performance of the transportation

network. One can assess the criticality of a corridor using indicators such as the average annual daily traffic (AADT), functional class of the corridor, the number of redundant routes and the reliability of those routes. In practice, AADT drives many decisions in transportation investment decision making. At both the local and state levels, decision makers are always trying to reduce the impact of negative results or consequences. As such, in improving operational levels of transportation networks, corridors, or routes with relatively higher AADT are always attractive alternatives for decision makers. Equally important, vulnerability drives the relative importance of alternatives for investment.

On a corridor level, depending on the level of assessment, a corridor's vulnerability to failure is an aggregation of the vulnerability to failure of each asset category (i.e., integrated asset management). Consequently, alternatives with more vulnerable asset categories will generate higher attribute scale increasing the relative importance of the corridor. The economic, environmental, and geographic characteristics of a corridor can all contribute to the relative importance of an alternative for possible improvement. Examples of attributes an analyst can identify for use in an integrated corridor-level risk assessment may include: AADT; functional class of road; percentage of trucks plying the corridor; percentage of asset category considered vulnerable; number of exits on corridor leading to commercial, industrial, or residential area; county population, etc.

4.5 Scaling Decision Attributes or Criteria

It is imperative that decision makers or analysts—in the process of evaluating alternatives against a set of defined attributes or criteria—ensure that each decision criterion or attribute is standardized for scaling uniformity. In theory, variety of measuring scales exists on which decision makers can rely in standardizing attributes or criteria. These scales can be broadly

characterized under four categories (Kirkwood, 1997): nominal, ordinal, interval, and ratio scales. Nominal scaling involves the assignment of numbers or names to some defined categories. Nominal scales are simply labeling categories without giving any numerical significance to each level or without any order of significance. On the other hand, ordinal scaling involves assigning order of importance to different alternatives without any significance to how much each of the alternatives differs from the others. For instance, given three alternatives with low, medium, or high ordinal scales, a decision maker will be willing to prioritize the alternative with high ordinal scale without knowing specifically how much the medium-scaled alternative differs from the high- or low-scaled alternative. Ratio scales have absolute zero, which allows for a wide range of both descriptive and inferential statistical analysis. Finally, in the interval scale, attribute scales are measured on an interval between 0 and 1, or 0 and 100. Accordingly, zero represents the least preferred and 1 or 100 most preferred. This type of scaling gives more significant meaning to decision making.

The performance of each attribute is transformed so that each factor is positively correlated with decision makers' preference. Interval scales give us the order of values and the ability to quantify the difference between competing alternatives. As such, alternatives with higher scales represent the most likely alternatives a decision maker will favor. Voogd reviews a variety of options for scaling decision attributes (Voogd, 1983). The HARM framework provides flexibility for analysts to adopt and utilize a scaling method that is appropriate and practical regarding their unique circumstances. The models presented in this dissertation utilize the interval and ordinal scaling methods: the exponential value function and the direct scaling or preference rating approach. The advantages of these methods are 1) exponential value functions offer meaning to the differences between measured attributes. That is, the numerical amount

between two scaled attributes gives a relative indication of the amount of preference difference; as such, increasing the objectivity of model results and 2) ordinal scaling alleviates the struggle and difficulty to acquire data that is not readily available to decision makers. Direct rating or preference rating offers decision makers the flexibility of converting stated preferences into vulnerability likelihoods. This analytical transformation enables semi-objective estimation of failure rates and consequences based on expert judgment.

4.5.1 The Exponential Value Function

“A value function is a real-valued mathematical function defined over an evaluation criterion (or attribute) that represents an option’s measure of “goodness” over the levels of the criterion” (Garvey, 2009). Among a set of competing alternatives, the value function offers decision makers the ability to assess the attractiveness of each alternative. An exponential value function allows an analyst to assign values ranging from zero to one representing the performance of each attribute. Practically, decision makers or analysts prefer alternatives that score higher in attribute value (representing higher-risk alternative) to alternatives with least-scored attributes (representing lower-risk alternative). The exponential value function is similar to the piecewise linear single dimensional value functions; however, the exponential value function is more useful because of its capability to handle numerous level scores. The exponential value function is capable of representing either increasing or decreasing values (preferences) for continuous range of criteria scores (Kirkwood, 1997). For monotonically increasing scores for a given criterion X , the exponential value function is represented mathematically and graphically as in equation (4.4) and Figure 4.2:

$$u(x) = \begin{cases} \frac{1-e^{-(x-x_{min})/\rho}}{1-e^{-(x_{max}-x_{min})/\rho}}, & \rho \neq \infty \\ \frac{x-x_{min}}{x_{max}-x_{min}}, & \rho = \infty, \end{cases} \quad (4.4)$$

Where

$u_X(x)$ = Score of a given value x , for criterion X , $0 \leq u_X(x) \leq 1$

x_{min} = Minimum value of criterion X

x_{max} = Maximum value of criterion X

ρ = Exponential constant

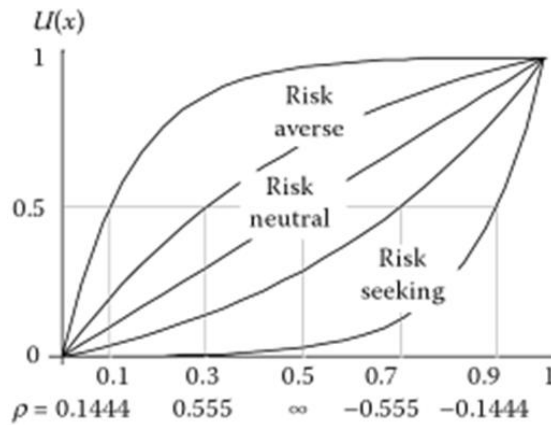

Figure 4.2 Families of Monotonically Increasing Exponential Value Functions (Garvey, 2009)

Conversely, for monotonically decreasing scores for a given criterion X , the exponential value function is represented mathematically and graphically as in equation (4.5) and Figure 4.3:

$$u_x(x) = \begin{cases} \frac{1-e^{-(x_{max}-x)/\rho}}{1-e^{-(x_{max}-x_{min})/\rho}}, & \rho \neq \infty \\ \frac{x_{max}-x}{x_{max}-x_{min}}, & \rho = \infty, \end{cases} \quad (4.5)$$

The terms are as previously defined.

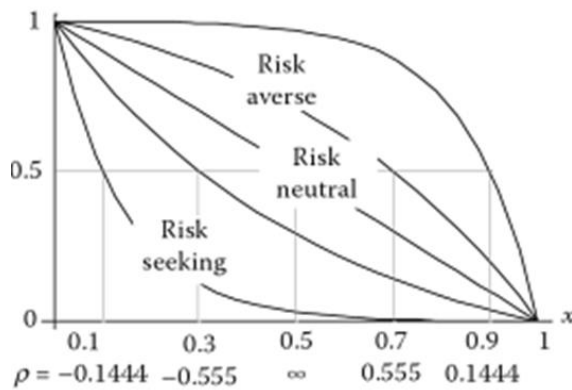

Figure 4.3 Families of Monotonically Decreasing Exponential Value Functions (Garvey, 2009)

4.5.2 Direct Attribute Scales

Direct attribute scaling is a member of the ordinal scaling methods. In direct scaling, decision makers or analysts assign ordinal scale levels as a measure of attainment or preference of an evaluation criterion. As already stated, in ordinal scaling, the difference between scales does not measure the relative preference of a decision maker with respect to an evaluation criterion. Assigned scales only offer a sense of ordering that indicates that one alternative is preferable to the other. As such, alternatives A and B with criterion scores 2 and 4, respectively, do not imply alternative B is twice as preferable or beneficial than A. That is, the two scales do not inform a decision maker how much one alternative is more valuable or preferable to the other. However, it offers decision makers the ability to make an informed decision that B is preferable to A. Table 4.1 is an example of a von-Neumann-Morgenstern direct scale constructed for risk analysis (Cox, 2007).

Table 4.1 von-Neumann-Morgenstern Utility Scale

Utility Scale	Ranking	Probability/Consequence Scale
0-0.2	1	Low
0.2-0.4	2	Medium
0.4-0.6	3	Moderate
0.6-0.8	4	High
0.8-1	5	Extreme

4.5.3 Surrogate Attributes

Oftentimes, analysts or decision makers encounter data availability problems in decision modeling and analysis. In such circumstances, practitioners are compelled to assess performance, conditions, or benefits of engineering systems using substitute attributes. The lack thereof of impeccable and quality data for the assessment of a particular risk attribute requires analysts or decision makers to give meaning to surrogate attributes relying on imprecise data. When decision makers do not have reasonable data that sufficiently capture the attribute under consideration, they measure surrogate attributes. Decision makers and analysts must understand that overcoming data problems in asset management, and most especially ancillary highway asset management, will require the use of surrogate attributes until data become available as their management systems mature. For example, consider a decision maker assessing an attribute, C_i , the vulnerability of failure, of a given structure j .

In the absence of deterioration models, historic condition data, and failure data on this structure, a decision maker or analyst cannot explicitly define the decision attribute C_{ij} , the vulnerability scale of attribute i for alternative j . Consequently, an analyst or a decision maker can depend on surrogate attributes defined using remaining expected useful life of the structure if a practitioner or modeler has installation date and expected useful life of the structure under

investigation. In this case, one can observe that an analyst or a decision maker does not directly capture the vulnerability to failure of the structure; however, all things being equal, the surrogate attribute indirectly reflects the state of reliability of the given structure. Similarly, decision makers can establish surrogates for other decision attributes with incomplete or imprecise data. In fact, Keeney and Raiffa assert that it is arguable that all attributes are surrogate attributes since practitioners are not capable of absolutely measuring all things (Keeney & Raiffa, 1993). In other words, nothing can be measured absolutely. This assertion buttresses the fact that there is value in depending on surrogate attributes in decision making as long as one can justify the reasoning behind the use of such attributes.

4.6 Formal Consensus Building Methods

In scaling attributes using the direct preference and surrogate methods, decision makers and analysts need to reach a consensus on the scales or possible levels of each attribute. Since these methods are subjective in nature, the tasks involved require a better understanding of the system. For this reason, expert knowledge becomes very critical in assessing surrogate attribute levels. For example, consider that decision makers want to assess the risk of failure for a given asset category. However, the analyst does not have complete data to model the probability and consequences of failure. This situation will require the modeler to assign some levels of scale that represent the probability scale as well as the consequence scale. To obtain a reflective scale of the situation and establish a consensus, the modeler can elicit collective information from experts of the infrastructure or system. Although the HARM framework is not prescriptive with which consensus building approach to adopt, the dissertation discusses one of the consensus methods (Delphi method) most commonly used in the transportation industry. This approach is further implemented as part of evaluating the efficacy of the HARM framework.

In the past, decision and policy makers have routinely relied on expert opinions to make decisions. However, gathering these opinions in a structured format did not start until after World War II (Ayyub, 2001). Ayyub defines expert opinion elicitation as “a heuristic process of gathering information and data or answering questions on issues or problems of concerns” (Ayyub, 2003). In eliciting expert opinions, analysts can rely on a variety of elicitation techniques that can be classified under three broad methods: indirect elicitation, direct method, and parametric estimation (Ayyub, 2001). The complexity of the problem can influence the choice of method analysts use to elicit required information. In addition, each method has its own strengths and limitations. As such, acknowledging the limitations of a method and addressing them accordingly can improve the quality of information experts provide. In general, the method one selects depends on one’s comfort level, experience, complexity of the problem under investigation, and resources availability. For a review and discussion of eliciting techniques, readers can consult Burgman, et al. (2006).

4.6.1 The Delphi Method

One of the early elicitation strategies, the Delphi method, was originally developed and used by the Rand Corporation in the 1950s (Dalkey & Helmer, 1963). The purpose of the method is to achieve a consensus or a convergence on a specific problem. Through the use of a series of questionnaires, the Delphi method elicits experts’ opinions on a real-world complex problem until a consensus is reached, or their responses reach equilibrium. In the literature, researchers have used this method to solve a wide range of problems, including resource allocation, policy selection, and program planning (Delbecq et al., 1975). During the process, a facilitator administers several rounds of questionnaires to a group of experts until a consensus or equilibrium is reached.

By conducting several iterations of a survey, prior comments or results serve as feedback for the next iteration. After the first survey and subsequent iterations, respondents are provided with the results and follow-up questions to verify if they may want to modify their responses due to others' opinions while keeping the participants' identity concealed. The required number of iterations depends on how quickly the panel of experts reaches a consensus or equilibrium. In some cases, respondents may not reach a consensus. When this situation ensues, the survey can be terminated if the same responses are received following a previous iteration. In theory, researchers have determined that at most between three and five iterations are practically sufficient to gather meaningful thoughts on a given problem (Hsu & Sandford, 2007).

Even though the overarching objective of the consensus-building approach is to explore reliable and creative ideas or produce suitable information for decision making, some of the methods have stronger advantages than others. The Delphi method offers a number of advantages making it appropriate to adopt for this framework. For example, the Delphi method eliminates the "bandwagon effect" (i.e., respondents are not gratuitously influenced by an outspoken respondent on the panel) due to the anonymity of participants. As a result, this method offers a means of gathering unbiased information from a panel of experts. In addition, the Delphi method allows one to work with a group of people in different geographical locations, i.e., participants need not be assembled at one location, as compared to the brainstorming or workshop technique.

4.6.2 Establishing a Panel of Experts

The panel of experts' experience and knowledge regarding the research problem determine the quality of information the researcher gathers through the Delphi process. Therefore, to gather quality and useful information, researchers must ensure that the panel

consists of practitioners who have worked in the field of study and understand the problem under investigation. First, the investigator must establish some basic criteria that each member must meet and narrow the selection down to reliable individuals willing to participate in all the required iterations of the survey. Since the Delphi method involves a number of iterations, the investigator must initially inform the panel and encourage them to participate fully.

To accomplish the selection of the panel, Pill suggests a number of guiding principles that investigators can employ. The author considers individuals eligible to contribute to the Delphi process to have fairly related backgrounds and experiences concerning the research problem, to be capable of contributing helpful inputs, and to be willing to modify their initial or previous judgments for the purpose of reaching or attaining consensus (Pill, 1971). The selection process can be challenging; however, the literature offers diverse ways of selecting qualified individuals to form the panel (Jones, 1975). The optimum number of individuals required to constitute the panel is arguable. That is, the size of the panel is determined on a case-by-case basis. There is extensive literature on the criteria one uses to select the panel of experts. Ultimately, the investigator must be convinced that the results represent general opinions on the specific problem.

4.6.3 Application of the Delphi Method in the Transportation Sector

In the literature, researchers have pervasively demonstrated the strengths of the Delphi method in decision analysis, planning, and policy development; especially, gathering complete information on systems, or assessing the impacts of successes and failures of systems. Specifically in the transportation sector, researchers, transportation analysts, and decision makers have successfully employed the Delphi method in different dimensions of decision analysis when complete data does not exist. For instance, Saito and Sinha used the Delphi method to elicit

expert opinions to develop guidelines for appraising bridge improvement needs. More specifically, the authors used the gathered information to establish relationships between subjective bridge condition ratings and FHWA's numeric ratings. This allowed the authors to assess relationships between the subjective rating and the severity and extent of distress, and also find relationships between the numeric condition rating and the expected remaining service life of bridges. Finally, they estimated the effect of improvements upon the numeric condition rating and expected remaining service life of bridge components (Saito & Sinha, 1991).

Further, Boadi and Amekudzi demonstrated that the Delphi method is a practical approach for decision makers to prioritize critical asset classes that are under the jurisdiction of a transportation agency for inclusion in formal asset management programs. The authors showed that in the absence of complete data, a Delphi study can be conducted to identify asset classes that pose the highest levels of threat to the goals of a transportation agency and to rank the relative likelihoods of occurrence of these threats. The paper demonstrates that the Delphi method can be used to gather expert opinion to identify and prioritize high-risk ancillary transportation asset classes within a transportation network (Boadi & Amekudzi, 2014).

Additionally, researchers have used the Delphi method in seeking consensus from experts in developing meaningful indicators that measure both pre-disaster resilience and post-disaster recovery of infrastructure. In one such case, Jordan and Javernick-Will conducted multiple rounds of Delphi survey to gather expert opinions on recovery indicators (Jordan & Javernick-Will, 2013). Although the study achieved consensus on several of the indicators, the results also showed some disparities in importance ratings. Overall, the outcome of the study shows that practitioners can use condensed opinions of experts in the field of disaster recovery and planning. Other areas researchers have applied the Delphi method is in land use and

infrastructure provision. Since transportation infrastructure and land use pattern are correlated, decision makers can assess the effects of land use patterns on transportation infrastructure (i.e., utilization and performance). Although some modeling techniques exist in land use forecasting, Cavalli-Sforza and Ortolano used the Delphi approach to predict the impacts of three alternative transportation programs in San Jose, California (Cavalli-Sforza & Ortolano, 1984). The study yielded a set of forecasts of land use, commute patterns, and choice of transit mode for three different transportation investment programs.

Similarly, Robinson used the Delphi method to assess the economic impacts of different road infrastructure investments programs (Robbinson, 1990). This method helps asset owners to make economic justification to decision makers for additional funding in times of budget shortfalls. The author conducted three rounds of Delphi survey to elicit expert opinions on the subject. Finally, the author concluded that the Delphi technique is capable of achieving the goals set for it as well as serving as a tool for building a solid framework for more quantitative economic impact forecasts. The study also provided an ideal framework for strategic planning by public agencies and private firms. Although the results of the Delphi study are subjective, they tend to rely on observable phenomena, trends, or facts. Therefore, analysis resulting from a Delphi study can provide valuable information that serves as a point of departure in strategic planning. These studies demonstrate that the Delphi method is beneficial when other methods are not adequate or appropriate for data collection.

4.7 Problem Formulation

In transportation operations, corridor failures—resulting from an infrastructure failure—can potentially give rise to different types of risks. Depending on an agency’s goals and objectives, one can define different categories of risk that will impact these goals or objectives. Generally,

risks arise from the possibility of deviation from an expected outcome or event. Some risks an agency will be interested in addressing include strategic, physical infrastructure, safety, or agency reputation. The overall risk of failure of a corridor considered in this model incorporates different attributes to estimate each type of risk an agency is considering to manage. As a bulk indicator, the bulk risk score is defined as including: (1) the corridor criticality index, i.e., the impact a failure will have on an agency and users of the corridor, i.e., the consequence of failure; and 2) hazard exposure-vulnerability index, i.e., the likelihood or vulnerability of the corridor to failure.

The hazard exposure-vulnerability index is very important in the risk assessment process because infrastructure vulnerability to failure or the degree of exposure of a hazard to society is the most important risk source in corridor operations. Generally, failure rates increase as the conditions of the infrastructure deteriorate due to aging and continual usage. Preserving the transportation network and operating it at acceptable levels of performance will require the management of risk. Most importantly, managing these risks in a group or integrated context increases the chances of a network performing highly or meeting its goals. Figure 4.4 illustrates the components of the risk elements and the attributes considered in the problem formulation.

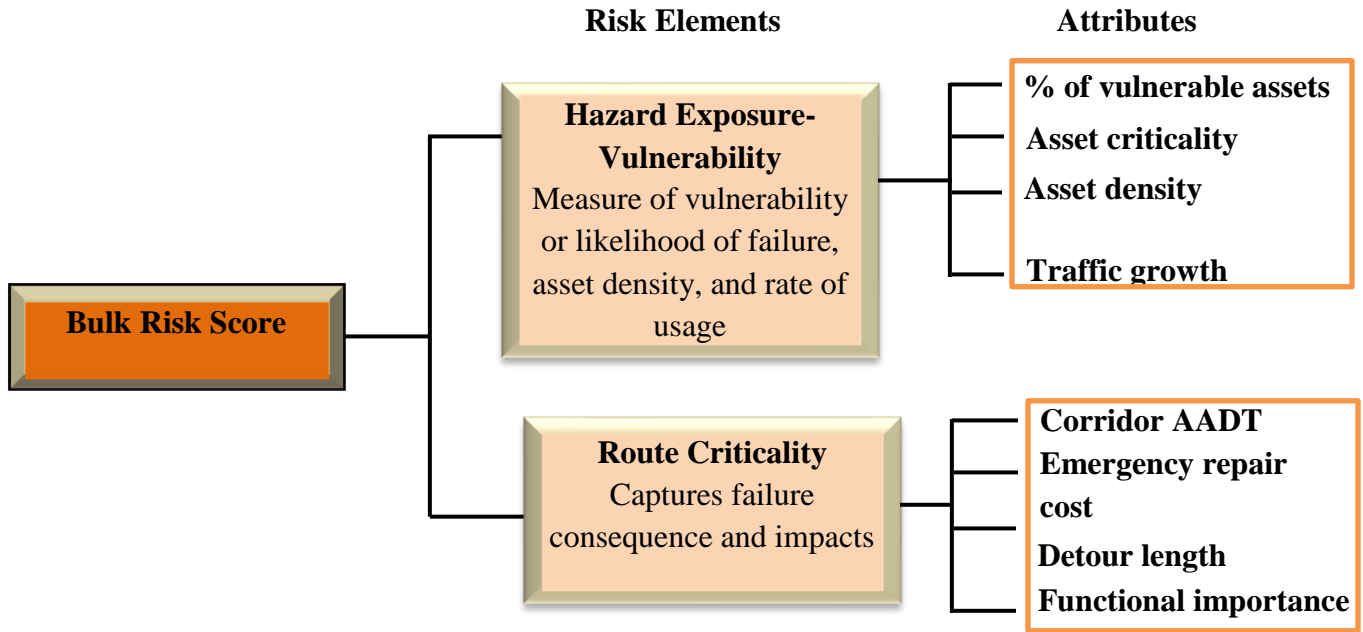

Figure 4.4 Definition of Risk Elements and their Main Attributes

4.7.1 Hazard Exposure-vulnerability Index (HV_c)

The hazard exposure-vulnerability index, which is denoted as a surrogate for the probability of failure, is determined by a number of criteria. The different criteria used capture the criticality of a given asset category, the density of assets indicating the number of plausible failure points, public exposure to the hazard or vulnerability over a finite period of time (agency’s planning horizon) indicating the rate of usage, and vulnerability of a corridor to failure, as a result of a failing asset or imminent hazard. Equation (4.6) represents the general functional form of the exposure-vulnerability index. This index informs decision makers about the likelihood of an unfavorable incident occurring over the corridor.

$$\text{Hazard exposure – vulnerability index, } HV_{c_j} = \int_{t_1}^{t_2} f(W_i, V_{ij}, E_i, X_j(t), K_j, U_{ik}) dt \quad (4.6)$$

Where

W_i =Weight factor for asset category i ,

E_i =Exposure factor for asset category i ,

V_{ij} =Vulnerability factor for asset category i within corridor j ,

U_{ik} =Interdependence vulnerability effect factor of asset category i on asset category

k, X_j =Traffic growth factor for corridor j ,

K_j =Network effects vulnerability factor for corridor j , and

t_1, t_2 = Analysis periods.

4.7.1.1 Estimating the Asset Category Exposure Factor, E_j

As mentioned earlier, the exposure factor for each asset category captures the number of assets or hazards per mile of road segment (i.e., threat density). To estimate this risk criterion factor, this dissertation employs a monotonically increasing exponential value function; i.e., equation (4.4). As an illustration for an asset category or hazard i , x_i represents the number of assets or hazards per mile of road segment. In this scenario, the road segment, r , represents an alternative. Therefore, the variables for the value functions are estimated as follows:

$$x_{i_r} = \frac{\text{number of assets or hazards on alternative } r}{\text{total miles of alternative } r} \quad r = 1, 2, 3, \dots \dots k \quad (4.7)$$

$$x_{min} = \text{minimum}(x_{i_1}, x_{i_2}, x_{i_3}, \dots \dots \dots, x_{i_k}) \quad (4.8)$$

$$x_{max} = \text{maximum}(x_{i_1}, x_{i_2}, x_{i_3}, \dots \dots \dots, x_{i_k}) \quad (4.9)$$

The constant ρ represents the risk appetite of a decision maker and is dependent on the $z_{0.5}$ – value, which is computed using equations (4.10) and (4.11). The R – value corresponding to a computed $z_{0.5}$ – value is obtained from a look up table (Kirkwood, 1991). Consequently, ρ is

computed using equation (4.12). The midpoint value corresponds to the preference value such that the value difference between the lowest and highest score is the same. The shape of the exponential value function depends on the magnitude of the midpoint value. The multiplicative factor in equation (4.11) depends on the risk attitude of the decision maker. A risk-averse decision maker will select a lower multiplicative factor.

$$Z_{0.5} = \frac{\text{midpoint value} - x_{min}}{x_{max} - x_{min}} \quad (4.10)$$

$$\text{midpoint value} = (0.15 * x_{max}) + x_{min} \quad (4.11)$$

$$\rho = R * (x_{max} - x_{min}) \quad (4.12)$$

4.7.1.2 Estimating Asset Category Vulnerability Factor, V_i

There are several definitions of vulnerability depending on the context and industry of use. For example, in climate change adaptation analysis, the Intergovernmental Panel on Climate Change (IPCC) defines it as “the degree to which a system is susceptible to, or unable to cope with, adverse effects of climate change, including climate variability and extremes” (IPCC, 2007). In systems analysis, “vulnerability is the manifestation of the inherent state of the system (e.g., physical, technical, organizational, cultural) that can be exploited to adversely affect (cause harm or damage to) that system” (Haimes, 2006). In risk analysis or management, vulnerability assessment is imperative.

Generally, vulnerability assessment requires information about the current condition, maintenance history, deterioration trend, or exposure of the system to threats. In fact, in practice, vulnerability assessment is data intensive if a decision maker seeks to make objective decisions that are informed by quality quantitative data. Therefore, it is vital that asset managers adopting

the model presented in this dissertation make efforts to gather quality data that can inform the vulnerability assessment process. However, in situations where actual condition data or a deterioration model is not available, decision makers can employ other surrogates that are able to capture an asset's vulnerability or probability of failure. Although the use of surrogates becomes a reasonable approach to vulnerability assessment, these variables often do not comprehensively capture inherent uncertainties. As such, the use of actual asset or system deterioration models is mostly recommended in the application of this framework. In effect, users of this framework can acknowledge that using deterioration models in the assignment of vulnerability scales will be more effective compared with the use of surrogates.

Surrogates that one can use to assess vulnerability in the absence of actual condition data or a deterioration model may include, but are not limited to, the remaining useful service life of the asset. The assumption is that, all things being equal, the further an asset is into its useful service life, the more its vulnerability to failure increases as well. With this premise, analysts or decision makers can construct different vulnerability to failure levels for an asset category under consideration. In the case study implementation section (Chapter 5), the dissertation presents some of the surrogates adopted in assessing the vulnerability of failure for each asset category that does not have actual condition data.

4.7.2 Corridor Criticality Index

The corridor criticality index is a proxy for the consequence element in the risk definition. The estimated index captures the impact or severity of losing a corridor taking into consideration the functional importance, economic importance, safety risk, and route usage. Equation (4.13) shows the general functional form of the corridor criticality index. Some of the criticality criteria used to measure the consequences include average annual daily traffic

(AADT), percentage of truck traffic, highway functional characteristics, detour length, and response time to recovery of the corridor.

$$\text{Criticality index of corridor } j, C_j = f(W_i, R_i) \quad j = 1, 2, \dots, m \quad (4.13)$$

Where

W_i = Weight of criticality element i ,

R_i = Criticality factor for criticality criteria i ,

n = Number of criticality factors, and

m = Number of alternative corridors under consideration.

4.7.3 Corridor Risk Score Estimate

Risk analysts estimate risk using many and diverse approaches. Usually, the experience and background of an analyst, data availability, time, and resource availability determine the approach one adopts (Hubbard, 2009). Once an analyst assesses the basic elements of risk, probability/likelihood and consequence, or its proxies, one can combine these elements to estimate the risk. Using this risk score, analysts or decision makers can rank alternatives under consideration. Most often, decision makers may prioritize alternatives that score high in the ranking process. However, in practice, decision makers consider other factors, such as costs, benefits, and effectiveness of risk reduction measures, in making risk management decisions (Ayyub, 2003).

In this research, Equation (4.14) shows the relationship between the overall risk score and the risk elements (C_j, HV_{C_j}). Equation (4.14) aggregates the risk elements into a mono-criterion function that defines the level of risk of a particular corridor. This transformation enables decision makers or analysts evaluate alternatives using comparable units.

$$\text{Risk Score of corridor } j, RS_j = w_1HV_{c_j} + w_2C_j, \text{ and } w_1 + w_2 = 1 \quad (4.14)$$

That is, the parameters w_1 and w_2 are the respective weights assigned to the risk elements. For instance, a decision maker may need to emphasize vulnerability; as such, one can assign higher weights to reflect this preference.

4.8 Sensitivity Analysis

Generally, sensitivity analysis in any decision analysis process involves the variation of model input(s) to determine the resulting relative variation in model output(s). One value that this framework and model offer is the flexibility and transparency in controlling model inputs to evaluate outcomes and alternatives. The ability to manipulate input variables allows decision makers to identify the variables that most influence model output. This process is known as sensitivity analysis. Sensitivity analysis allows decision makers to ask “what-if” questions. In risk assessment, sensitivity analysis allows decision makers to systematically investigate how the variability of input factors influences risk estimates and thus risk-based decisions. If this information is presented quantitatively, it helps decision makers to understand different scenario analysis and the outcomes that could result. The complexity of the sensitivity analysis depends on the dependency of the input variables. Overcoming the complexity can require sophisticated modeling tools. However, with proper software, these sophistications can be implemented very easily.

In practice, practitioners and researchers have used different types of sensitivity techniques. Studies have shown that all techniques tend to produce similar level of sensitivity results (Hamby,1995). These techniques can be categorized as either “local” or “global”. A local sensitivity analysis deals with point estimates of parameter values while global analysis

examines the effect on output parameters of range variation of input variable(s). A simple quantitative and intuitive sensitivity analysis approach is the method of varying parameter values one-at-a-time (Hamby, 1994). This method can be easily conceptualized as evaluating the risk estimates of alternatives twice, each time using different plausible weighting, priority, or criticality scales or factors. From these estimated values, a sensitivity ratio (SR) is computed (using Equation 4.15) to determine the relative sensitivity of the risk estimate to each of the varied variables. The input variables that yield the highest absolute SR values are considered as the most sensitive variables. These are the key variables decision makers can pay attention to in mitigating any risk or making risk-based decisions. Information resulting from this kind of investigation guides decision makers in targeting additional resources in areas that offer the most improvement.

Mathematically, the SR, also known as the elasticity equation, is formulated as follows:

$$\text{Sensitivity Ratio, } SR = \frac{\left(\frac{O_2 - O_1}{O_1}\right) * 100\%}{\left(\frac{I_2 - I_1}{I_1}\right) * 100\%} \quad (4.15)$$

Where,

O_1 = the baseline value of the variable using baseline values of input variables

O_2 = the value of the output variable after changing the value of one input variable

I_1 = the baseline point estimate for an input variable

I_2 = the value of the input variable after changing I_1

4.9 Model Assumptions

It has been previously established that mandates enforcing the systematic management of ancillary highway assets are often lacking. As such, attempting to incorporate this DSS in any decision making process will face some challenges: lack of standards; lack of performance metrics and targets; limited data, such as installation year, asset dimensions and condition data; and the lack of deterioration models. For these reasons, analysts and decision makers will need to make assumptions that require input from experts. The framework developed by this research makes a number of assumptions in constructing scales for the criteria used in estimating the risk elements: hazard exposure-vulnerability and criticality indices. These assumptions enable analysts to relatively simplify and replicate the method for different agencies with different data challenges.

Adopting this framework and using more detailed and localized inputs, where available, improves the estimation of risk components. It is important to note that these assumptions are not static and may change as more information becomes available. However, these modifications do not reduce the efficacy of this model because they represent the best knowledge that decision makers have at any point in time, and continue to be refined as more data is collected. Generally, decision makers may have different risk appetites. Therefore, the model allows for analysts or decision makers to modify the assumptions to meet their objectives. Essentially, once this initial model is constructed, decision makers or analysts can adjust the criteria and scaling constants to reflect changes in priorities and situations. Since each situation or DOT is different in terms of data availability, the assumptions are not generalized, but are tailored to each DOT used in the case study. As such, the dissertation presents the assumptions adopted for each DOT in the implementation section (Chapter 5).

Chapter 5 FRAMEWORK APPLICATION AND DISCUSSION OF CASE STUDY

RESULTS

5.1 Framework Application

To better understand the applicability of HARM-DSS, the developed framework and models were applied to three DOT cases. In this chapter, the dissertation integrates different asset and hazard data with notable differences in the data completeness and extent of coverage. This data was gathered from three different State DOTs. This chapter describes the framework application, the approach used to collect and analyze independent data to support the model, and the subsequent results. Specifically, the following sections thoroughly explain the practical implementation of the framework, case study results, and the application of the results in policy development, budgetary planning, and effective resource allocation and utilization. In addition, the sections elaborate upon the assumptions adopted in implementing the framework. Areas of interest include the conversion of inventory and performance or condition data to vulnerability measures, development of quantitative risk factors from subjective qualitative measures, and evidence of decision makers' ability to effectively identify, distinguish, and prioritize among corridor alternatives with different vulnerabilities to failure and similar potential consequences.

5.1.1 Applying Phase One: Asset Category Priority Assessment

The framework proposed by this study (see Chapter four) consists of two phases. The ultimate objective of the first phase is to support or complement asset management activities of DOTs that are in the process of identifying the most critical category or categories of ancillary assets to prioritize, beyond pavements and bridges, for systematic management. This process also involves the assessment of individual asset vulnerability to failure. In these case studies,

phase one of the framework was not explicitly implemented because the fundamental premise for the selection of case study DOTs was based on data availability. Specifically, the fundamental guiding principle in selecting case study DOTs was to identify DOTs that have already gathered data on some categories of ancillary assets. This implies that if a DOT has already started gathering data on a particular ancillary asset or hazard class, then the assumption is the agency has already undertaken phase one of the framework and identified those asset or hazard categories as their critical assets or hazards. Consequently, data on asset vulnerability to failure would be available. However, for datasets with no vulnerability data, practical surrogates can be deduced from the data. On the other hand, a DOT starting to identify highly critical asset or hazard categories can start by implementing the first phase of the framework.

Due to the study constraints, it was assumed that the case study agencies have performed a systematic assessment (similar to what is proposed by this study) leading to the identification of those asset systems the DOTs currently have in place. Accordingly, the emphasis of this case study analyses is on the second phase of the framework. To demonstrate the validity and practical value of the first phase of this framework, Boadi and Amekudzi (2014) have demonstrated and presented the results of a case study in the paper titled “Risk-based Management of Ancillary Transportation Assets: Applying the Delphi Method to Estimate the Risk of Failure”.

5.1.2 Selection of Case Study DOTs and Data Acquisition

As mentioned earlier, the purpose of the case study was to apply the concepts, framework, and models discussed in chapter four to specific data and ascertain the expediency of the results in policy development and resource allocation and utilization. Fulfilling these goals would require information systems (both inventory and inspection data) for at least two categories of

ancillary highway assets or hazards. The first task was to identify DOTs undertaking any activities involving the systematic collection or management of data related to ancillary highway assets through a literature review. In addition to reviewing the literature on ancillary asset management, interviews were conducted with asset management representatives, data specialists, the information technology offices, and lead engineers at DOTs to identify plausible data.

The overarching objective was to identify DOTs that maintained information systems for at least two different categories of ancillary highway assets. The second task was to determine which of these DOTs were willing to share this data for the analysis. Initially, six DOTs were identified to be maintaining information systems for at least two of the interested ancillary highway asset categories. However, three of the six were willing to share their data. The DOTs that agreed to offer data were:

- Minnesota Department of Transportation (MnDOT)
- New York State Department of Transportation (NYSDOT), and
- Oregon State Department of Transportation (ODOT)

5.1.3 Data Limitations

Despite the comprehensiveness and robustness of the framework in accommodating wide-ranging data types, there are some key limitations with the data that reduce the potential benefits this framework can offer decision makers in policy analysis and development. As noted earlier, DOTs were identified based on their efforts in gathering and maintaining information on ancillary assets. Therefore, the data was not purposely gathered to conform to the requirements of the model input data. Hence, the data has some inherent weaknesses that can affect the effective application of the framework to support decision analysis. Notably, the level of detail

and completeness of the data varied significantly from one system to the other as well as from state to state. Specifically, the main data issues encountered include:

- lack of standards for assessing the condition of ancillary assets and consequently vulnerability assessment
- lack of complete asset data collected for all state highways and regions
- incomplete or missing condition data on assets in the database
- lack of meaningful documentation explaining codes used in the asset data base
- lack of geographic information associated with individual assets
- the use of different referencing systems to locate assets

Although addressing these issues is not the objective of this study, investing resources to address these issues can benefit DOTs to capture the full potential benefits this decision-support tool offers. For the purpose of these case studies, several assumptions were made to simplify the process. These assumptions are documented in the latter sections of this chapter.

5.1.4 Available Data Systems

In general, the data provided by the selected DOTs varied in asset category and extent of coverage. Nonetheless, culvert data was common among all the participating DOTs, although the type of information the individual systems contained varied significantly. This observation can be attributed to the fact that many DOTs gather culvert data as part of their bridge inventory system. Since Federal mandates require DOTs to maintain and report bridge data through the National Bridge Inventory (NBI), it has become commonplace for DOTs to gather data on larger culverts that meet certain standards. However, this practice is undertaken without a common standard for field data collection, resulting in diverse data fields observed in these systems.

Another reason for culverts being a common asset class among DOTs can also relate to the fact that many of these DOTs consider culverts to be the most critical ancillary asset class. In fact, a study by Boadi and Amekudzi found that survey respondents—to a Delphi study identifying and prioritizing high risk ancillary highway assets for incorporation into a systematic management system—ranked culverts as one of the highly critical ancillary asset among eight categories of ancillary assets and other hazards (Boadi & Amekudzi, 2014). The remaining classes of assets varied among the participating DOTs.

Table 5.1 shows the DOTs, available data, data extent, and the information used in assessing asset vulnerability.

Table 5.1 Data Availability and Extent

Agency	Data Systems	Data Extent	Condition or Vulnerability Assessment Information
Minnesota DOT (MnDOT)	Culverts	Statewide	Overall condition on a point scale (0-4)
	Overhead Sign Structures	CSAH: About 30,600 miles of roadway covering 87 counties	Three qualitative descriptions (Good, Review, or Damage) transformed to assess vulnerability
	Plate-beam Barrier		Elemental conditions combined to assess vulnerability
Oregon DOT (ODOT)	Culverts	Statewide	Utilization of remaining service life to assess vulnerability
	Unstable Slopes (Rockfall or Landslide)	Selected critical routes in 3 regions	Estimation of likelihood of failure: (Low, Medium, or High)
	Earth Retaining Structures (Walls)	Selected critical routes in 3 regions	Utilization of remaining service life to assess vulnerability
New York State DOT (NYSDOT)	Culverts	Statewide	Overall condition on a point scale (0-9)
	Guardrails	Region 5	Elemental conditions combined to assess vulnerability
	Unstable Slopes (Rockfall or Landslide)	Region 5 (Very limited)	Assignment of numerical ratings

5.1.5 Data Extent and Asset Vulnerability Assessment

As previously mentioned, there exists a correlation in the collection of culvert data and that of bridge data. As such, the culvert data DOTs provided covered the entire state highways that the DOTs are responsible for. Beyond culverts, the case study DOTs provided different types of ancillary asset data with different extents of coverage. The following sections describe

the type of information systems, extent of data coverage, and vulnerability assessment procedures adopted for each of the case study DOTs.

5.1.5.1 Minnesota Department of Transportation

5.1.5.1.1 Data Extent

In addition to the culvert information system (referred to as HydInfra System), MnDOT provided systems data for overhead-sign structures and plate-beam guardrails. The HydInfra system consists of condition and inventory data on culvert and storm drainage assets. Whereas the HydInfra system covered the entire state of Minnesota, overhead-sign and plate-beam guardrail systems were limited to County State-Aid Highways (CSAH). The CSAH system is a network of key highways under the jurisdiction of Minnesota's counties. The network covers roughly 30,600 miles of roadway throughout all 87 counties, comprising over two-thirds of all county highway miles. Counties receive money from the state to assist in the construction, improvement, and maintenance of those highways included in the state-aid system.

5.1.5.1.2 Asset Vulnerability to Failure Assessment

The information systems differed significantly in the type of data fields and information gathered and recorded. For the purposes of this research, the aim was to identify information that can be used to assess an asset vulnerability to failure. For their culvert information system, MnDOT assigns an overall condition index that is based on a point scale of 0 to 4, in which 1 is assigned to a culvert in excellent condition and 4 assigned to a culvert in very poor condition. Zero is used to describe culverts that are not accessible for rating. Using this information, three vulnerability scales were developed and used in assessing culvert asset vulnerability. For convenience and consistency, all unrated culverts were not used as part of the analysis. Table

5.2 represents the different rating schemes, their corresponding meaning, and the related assigned vulnerability ratings. This subjective vulnerability assignment allows for the assignment of quantitative factors that can be conveniently used in the model. It is important to understand that the results of the analysis will be sensitive to the vulnerability scales that will be developed.

Table 5.2 Culvert Condition Rating Codes and Vulnerability Ratings
(Adapted from MnDOT HydInfra Inspection Manual)

Condition Rating*	Rating Description*	Explanation*	Vulnerability Scale**
1	Excellent	Like new	1-low
2	Fair	Some wear but structurally sound	2-medium
3	Poor	Deteriorated, consider for repair	3-high
4	Very Poor	Serious deterioration	
0		Not able to rate, not visible	No rating assigned

*MnDOT classification; **HARM-DSS classification

MnDOT uses qualitative descriptions in assessing overhead-sign structures. Although a field in the database assigns a condition state description to individual signs, there was no detailed explanation about this assignment. The three condition state descriptions included Good, Review, or Damage. These qualitative descriptions were transformed into vulnerability ratings of low, medium, or high, respectively. Finally, plate-beam asset vulnerability was estimated through the combination of individual component conditions assessment. The plate-beam barrier databases rates individual run of guardrail using five main descriptions. Table 5.3 summarizes the descriptions and their corresponding meaning. Using these qualitative descriptions, three levels (codes) of asset vulnerability were developed.

Table 5.4 explains how vulnerability was assigned to the runs of plate-beam barrier. Table 5.5 also shows the qualitative descriptions of overhead-sign structures and the corresponding vulnerability scales. These assumptions were made to extract meaningful data from these information systems to validate the framework.

**Table 5.3 Plate-beam Barrier Condition Assessment
(Stefanski, 2014)**

Condition Description	Explanation
Functional	Hit that needs to be fixed
Non-functional	Open Guardrail
Cosmetic	Hit or rust that does not need to be fixed
End Treatment Broken	End treatment either hit or on the ground

Table 5.4 Plate-beam Barrier Vulnerability Assignment

Condition Description*	Vulnerability Scale**
Cosmetic	1-low
Functional	2-medium
Non-functional	
End Treatment Broken	3-high

Table 5.5 Overhead-Sign Structure Vulnerability Assignment

Condition Description*	Vulnerability Scale**
Good	1-low
Review	2-medium
Damage	
Other	3-high

5.1.5.2 Oregon Department of Transportation

5.1.5.2.1 Data Extent

ODOT maintains information systems for unstable slopes (i.e., including rockfall and landslide locations) and earth retaining structures (ERS/Walls). These systems covered selected critical routes identified by ODOT in three different regions (i.e., regions 1, 2, and 4).

5.1.5.2.2 Asset Vulnerability to Failure Assessment

ODOT's systems provided different asset information that was useful in determining the vulnerability of each asset to failure. For example, culverts and walls systems had a data field designated as the installation date for each culvert. Since no general condition data was provided for both culverts and walls, the remaining service life concept was used to determine the vulnerability level of each culvert and wall in the system. First, service life for each culvert and wall type was determined using data from the literature. Second, the current age of each culvert and wall was estimated using the installation year and analysis year. The age of the asset was then compared to the service life established for each type of culvert and wall.

The percentage remaining service life was determined for each culvert and wall. Culverts and walls that had exceeded 70% of their service life were considered to be highly vulnerable to failure. This data was used to determine all the highly vulnerable culverts and walls in the system. The 70% threshold adopted in this analysis was just an arbitrary number chosen and deemed subjective. A DOT performing this analysis could consider other numbers depending on their comfort level and experiences in dealing with the behavior of these assets. The most objective approach in determining the vulnerability of these assets is the use of deterioration models that can predict reasonable conditions of an asset using empirical data. However, in the

absence of these mathematical models, reasonable expert opinion as well as surrogates that capture performance will suffice for this purpose.

5.1.5.3 New York State Department of Transportation

5.1.5.3.1 Data Extent

NYSDOT provided two additional datasets (i.e., unstable slopes and guardrails) beyond culvert data. With the exception of the culvert data that had statewide coverage, the unstable slopes and guardrails data were only for one region (region 5). However, unstable slopes data was only available for limited sections of four different highways in three counties. Due to this data limitation, unstable slopes data from NYSDOT was not utilized in the analysis since it was not very representative of unstable slopes in the region. Consequently, NYSDOT case analysis was restricted to two classes of ancillary highway assets (i.e., culverts and guardrails).

5.1.5.3.2 Asset Vulnerability to Failure Assessment

NYSDOT's culvert system provided an overall general recommendation (using a point scale of 1 to 7) for culvert structures. This general recommendation is based on different individual items that are rated using a rating scale established by the NYSDOT culvert inspection field guide. The items rated include three broad categories: roadway items, structure items, and channel items. The roadway items consist of pavement condition, shoulders, guide railing performance, settlement around the location of the culvert, and embankment performance. The structure items include abutment and pier performance, span of barrel, and headwall and wingwall conditions. Appendix D shows the typical components of a culvert. The last item, channel items, include opening of the culvert, alignment, scour/erosion, silt, debris, and vegetative growth inside the culvert. Table 5.6 explains the inspection numerical rating scales

NYSDOT uses in assessing individual items of a culvert. The potential influence of the items on the overall recommendation scale depends on the importance of a given item. As such, the general condition of a culvert may or may not match the worse performing element in the list. Table 5.7 shows the rating scales used in making the general recommendations for the entire culvert structure.

**Table 5.6 NYSDOT Culvert Components Numerical Rating Scale
(NYSDOT, 2006)**

Numerical Scale	Explanation
9	Condition and/or existence unknown
8	Not applicable. Used to rate an item the culvert does not have
7	New condition. No deterioration
6	Used to shade between ratings of 5 and 7
5	Minor deterioration but functioning as originally designed
4	Used to shade between ratings of 3 and 5. Functioning as originally designed
3	Serious deterioration or not functioning as originally designed
2	Used to shade between ratings of 1 and 3
1	Totally deteriorated or in failed condition. Potentially hazardous

Table 5.7 NYSDOT Culvert General Recommendation Rating Scale
(NYSDOT, 2006)

Numerical Scale	Description
7	Like new condition. No repairs required
6	May require very minor repairs to pavement, guiderail, shoulders, etc.
5	May require minor repairs to the headwalls or wingwalls. May require removal of light vegetation growth around culvert openings.
4	Pavement may require replacement with the addition of backfill material to correct minor roadway settlement problems yet the structure shows no signs of deformation or settlement. Wingwalls and headwalls may require significant repair work. Some minor work to the channel may be required.
3	Significant repairs to the pavement are required due to settlement. Slight deformation and settlement of the structure exists. Significant deterioration of wingwalls and/or headwalls exists. Extensive work on the culvert is required. Replacement could be considered a better long term option.
2	Replacement of the structure is necessary due to serious deformation and settlement of the structure. Short-term, remedial action such as pavement replacement or installation of additional backfill material is required. Temporary shoring may be needed or already exist. A vehicle load restriction is probably posted. Replacement of wingwalls and/or headwalls is required. Alignment of waterway is such that significant, measurable and progressive, general and /or localized scour is occurring. Constriction or obstruction of the culvert opening greatly restricts water flow.
1	Pavement has settled as a result of significant structure deformation or settlement. Structure has collapsed or collapse is likely. Culvert opening is closed or nearly closed due to embankment soil failure, structure deformation, channel sedimentation, debris accumulation, or vegetation growth. Roadway should have traffic restrictions or be closed to traffic entirely.

Since the culvert recommendation description offers innate overall condition of the culvert, this information was used in assessing culvert vulnerability to failure. The assumption is that, all things being equal, a highly rated recommendation on the scale suggests the culvert structure is less likely or less vulnerable to fail (catastrophically or in performance sense). Likewise, a culvert with a low rating on the recommendation scale will be highly vulnerable to failure. These qualitative descriptions were transformed to a three-point ordinal vulnerability

scale of low, medium, and high. Table 5.8 explains the asset vulnerability scales implemented to assess the culverts.

Table 5.8 NYSDOT Culvert Vulnerability Assessment

Culvert Recommendation Scale*	Vulnerability Scale**
5, 6, and 7	1-low
3 and 4	2-medium
1 and 2	3-high

*NYSDOT classification **HARM-DSS classification

Similarly, NYSDOT Guiderail Asset Management System (GRAMS) provides inventory and inspection information for the purpose of guiding guardrail maintenance and replacement programs. The inspection information includes condition assessment of guardrail components: rails, posts, and terminals. NYSDOT assesses the conditions of each of these components based on the degree of physical deterioration, damage, and non-hardware issues. Physical deterioration in this sense refers to components physical effects ensuing from guardrail aging and corrosion or decay resulting from components exposure to the weather. Component deterioration tends to be consistent for a given run of guardrail. However, some localized deterioration can also be observed. Also, damage conditions refer to component defects resulting from impacts to the guardrail; for example, vehicle impacts caused by accidents or during snow removal.

These types of damage tend to be localized. The final issue assessed is non-hardware/safety issues. This assessment is undertaken to determine the functional performance of the guardrail with respect to design and surrounding conditions. For example, the height of a guardrail and the presence of fixed objects within the proximity of a guardrail that can affect the performance of the guardrail are assessed and rated using a numerical scale rating system (NYSDOT, 2008). The rating system used in evaluating guardrail components is similar to and

consistent with other rating systems NYSDOT uses in assessing culverts and bridges (see Table 5.6).

Table 5.9 shows an example of rated cable guardrail components. A similar procedure was adopted from Table 5.8 to assign ordinal vulnerability levels to individual guardrail runs. In order to deduce the overall vulnerability of each run of guardrail, the ratings of each component for any given guardrail were combined to describe the vulnerability level of the guardrail.

**Table 5.9 Example of Rated Cable Guardrail
(NYSDOT, 2008)**

RATING	DETERIORATION	DAMAGE	NON-HARDWARE
<p align="center">7 New</p>	<ul style="list-style-type: none"> • Rail, posts or terminals have recently been installed and show no signs of deterioration. 	<ul style="list-style-type: none"> <input checked="" type="checkbox"/> Rail, posts or terminals have recently been installed and have not been hit and show no signs of damage. 	<ul style="list-style-type: none"> <input checked="" type="checkbox"/> Rail, posts or terminals have recently been installed and meet current standards.
<p align="center">5 or 4 Minor Aging/ Deterioration</p>	<p>Rail:</p> <ul style="list-style-type: none"> • Cable can gradually stretch, leading to sag and a reduced ability to capture vehicles. Winter sag of over 2 inches or summer sag of over 4 inches warrants a rating of 4. <p>Post:</p> <ul style="list-style-type: none"> • A single badly deteriorated post or several mildly deteriorated posts warrants a rating of 5. <p>Terminal:</p> <ul style="list-style-type: none"> • Anchor blocks typically do not fail, but they may be high enough to snag the bottom of an errant vehicle or cause it to roll over. A block that projects 4 to 6 inches above the surrounding plane of the ground warrants a rating of 4. 	<ul style="list-style-type: none"> <input checked="" type="checkbox"/> Cable is very rarely damaged, though the splice connections may fail. Snapping of a single strand will not significantly reduce the cable's function. <input checked="" type="checkbox"/> Damage is more likely to cause posts to separate from the rail. The rail remains at roughly normal height, with only the loss of one or two posts on a weak post. <input checked="" type="checkbox"/> Two to four snapped strands. <input checked="" type="checkbox"/> With median rail, posts may be bent to point towards opposing traffic. These posts act as spears. <input checked="" type="checkbox"/> Modern cable terminals do not pose a fixed object threat after the rail is hit, however, if they move from their original positions, they no longer function as intended. 	<ul style="list-style-type: none"> <input checked="" type="checkbox"/> A single poorly supported post or several non-continuous posts. <input checked="" type="checkbox"/> Where curb is present from 1 to 10 feet in front of the rail, vehicles may vault over the guide rail. Where operating speeds are greater than 40 mph and curb is located between 1 to 10 feet in front of the guide rail. <input checked="" type="checkbox"/> Fixed objects located at beginning terminal. For example a terminal may have been placed just after a utility pole rather than providing some shielding. <input checked="" type="checkbox"/> Fixed object barely within the deflection distance.
<p align="center">3 or 2 Significant Aging/ Deterioration</p>	<p>Rail:</p> <ul style="list-style-type: none"> • Sag significantly more than 2 inches in winter and 4 inches in summer warrants a rating of 3. <p>Post:</p> <ul style="list-style-type: none"> • Three or more consecutive deteriorated posts warrants a rating of 3. <p>Terminal:</p> <ul style="list-style-type: none"> • An anchor block projecting more than 6 inches above the surrounding plane warrants a rating of 2. 	<ul style="list-style-type: none"> <input checked="" type="checkbox"/> More than 4 snapped strands. <input checked="" type="checkbox"/> Impacts may cause the anchor blocks to lean towards the run. At least once, the lean was sufficient that a cable end popped out of the end saddles on the next impact. If the block has rotated so that the anchor angle is nearly perpendicular to the direction a cable will be pulling, as the entire run of cable will be compromised. 	<ul style="list-style-type: none"> <input checked="" type="checkbox"/> If a side slope is close beyond the posts and drops away at more than 1:3, a deflecting vehicle may roll either over or under the deflected cable. With 16 foot post spacing, cable close to a steep drop-off. <input checked="" type="checkbox"/> While "legally" adequate, cable having 8 foot post spacing very close (within a foot) to the edge of a 1:2 side slope, as it probably has inadequate soil support or uses extra length posts that will permit deflection distances of over 8 feet, which is considered the critical distance for deflection close to steep slopes.
<p align="center">1 Failed</p>	<ul style="list-style-type: none"> • Rail, posts and terminals have individual or combined deterioration that no longer allows the cable guide rail system to function as originally intended. 		<ul style="list-style-type: none"> <input checked="" type="checkbox"/> Inadequate lateral soil support on three or more consecutive posts. <input checked="" type="checkbox"/> Fixed object well within the deflection distance.

5.1.6 Applying Phase Two: Corridor-level Risk Assessment and Prioritization

Following the data acquisition, asset category prioritization, and individual asset vulnerability assessment, the second phase of the framework can be implemented. The goal of the second phase is integrating asset data from phase one to perform corridor-level risk analysis and prioritization. The implementation of phase two of the framework requires detailed and extensive data on individual asset vulnerability and corridor alternatives, explicit strategic objectives of an agency, and the overarching purpose of the analysis. Assessing the risks of failure of a corridor entails determining the likelihood of failure of individual classes of assets or hazards (i.e., the likelihood of occurrence of a threat) located along the corridor, and the severity of potential consequences in losing a corridor to any threat. That is, the likelihood of occurrence of any threat to a corridor is dependent on the vulnerability of individual asset classes to failure. Consequently, as the density of vulnerable assets increases over a corridor, it is more likely the corridor may experience a loss to any of these assets failing. In these case studies, different approaches were adopted in assessing assets vulnerability to failure, detailed for each case study in previous sections.

This approach was adopted because 1) currently, there are no standards for determining ancillary highway assets vulnerability to failure and 2) the data available varied significantly in terms of the elements available to determine asset conditions and likelihood of failure. To implement the second phase of the framework, different risk types were emphasized: strategic (budget planning) and operational (safety, delay, economic development, etc.) risks. In effect, addressing these risks enables a DOT to address its institutional/organizational risk as well. Each risk type was assessed using different criteria. The list of criteria or attribute factors depends on the strategic goals of an assessing agency. Adopting a well-defined and documented

process for identifying these measures is recommended to ensure the replicability and transparency of the process. While there are no standard risk criteria for decision making, there exist few reasonable criteria decision makers and DOTs consistently adopt in policy development and decision analysis. Accordingly, accomplishing this process will require brainstorming techniques or peer-to-peer workshops among decision makers and analysts, with inputs from system users, to develop improved criteria. Next is to categorize, combine the risk factors or criteria, and rank each element used in characterizing risks.

Primarily, with regard to corridor-level assessment, each corridor (based on the definition one adopts) is classified as a potential alternative to consider for investment, improvement, or monitoring. In this research, each corridor was defined as a collection of different road segments. This road segment definition was used because the Shapefiles secured for each DOT were already segmented by unique IDs. Consequently, it was reasonable to assume that DOTs assessed their network based on these available segments. Each road segment was identified with a “begin” and “end” milepost allowing for the estimation of segment miles, alignment, and identification of assets or hazards (threats) within these mileposts. Each segment was then assessed to estimate its criticality, as a measure of potential consequence upon failure, and exposure-vulnerability to the threats, as a measure of the road segments likelihood to experience a loss.

5.1.6.1 Assessing Corridor Criticality

Corridor in this sense is defined as a road segment from a beginning milepost to an ending milepost, as presented by a DOT’s highway Shapefiles. These segments can be aggregated to form longer and continuous corridors depending on the purpose for which the corridor is defined within a transportation network. Estimating the corridor criticality index

requires few assumptions. For simplicity, similar assumptions were used in assessing corridor criticality index for all the case studies. For example, similar weights were assigned to each of the risk attributes used in assessing the level of corridor criticality across case study DOTs. However, for each DOT with different attitude towards priorities, different weighting scales can be developed and assigned to reflect the preferences of decision makers. For instance, a DOT may be more interested in addressing corridors that have higher potential in traffic growth over a specified period of time compared to the functional class of the corridor, since the amount of traffic is more likely to affect the rate of deterioration of assets over the corridor. Accordingly, a decision maker may assign higher weight to the traffic growth risk attribute relative to the corridor functional class risk attribute. Table 5.10 shows the risk criteria and weights used in estimating the criticality of each corridor. It is important to mention that these risk factors employed in the study are not exhaustive. In fact, additional or new risk items can be evaluated and added when a DOT strongly believes that their priorities warrant this action.

Table 5.10 Corridor Criticality Criteria and Weights

Criticality Criteria	Assigned Weight
Annual Average Daily Traffic (AADT)	0.2
Percentage of Truck Traffic (TTP)	0.2
Functional Classification of Road	0.2
Detour Length	0.2
Expected Traffic Growth	0.2
Total	1.0

After creating the risk criteria in Table 5.10, the individual criteria were rated on a four-point scale to allow for a quantitative analysis. To avoid classifying a corridor to have zero criticality, zero was avoided on the rating scale. Consequently, the scales ranged from 0.1 to 1: that is, with 0.1 representing relatively low criticality and 1.0 representing relatively high

criticality. For example, if a failure occurs, a corridor with relatively higher truck traffic will be highly impacted when assessing freight throughput (economic development). Accordingly, a relatively higher rating on the scale is assigned. Likewise, a corridor with relatively lower truck traffic is assigned relatively lower rating on the scale. Similar assignments are generated for the remaining risk criteria. This process allows one to estimate corridor criticality indices that are relative among available alternatives under consideration. For instance, a corridor's criticality index can only be compared to other corridors within the pool of alternatives under consideration. Table 5.11 to Table 5.13 show examples of criticality attribute scales used in the case studies.

Table 5.11 Annual Average Daily Traffic and Truck Traffic Criticality Scale

AADT	TTP (%)	Criticality Rating	Criticality Scale
Less than 10000	Less than 10	Low	0.1
10000<=AADT<50000	10<=%<20	Medium	0.3
50000<=AADT<100000	20<=%<25	Moderate	0.5
Greater or equal 100000	Greater or equal 25	High	1.0

Table 5.12 Detour and Traffic Growth Criticality Scales

Detour (d mins)	Traffic Growth (p%)	Criticality Rating	Criticality Scale
Less than or equal 25	Less than or equal 10	Low	0.1
25< d <= 60	10< p <= 30	Medium	0.3
60< d <= 120	30< p <= 50	Moderate	0.5
Greater than 120	Greater than 50	High	1.0

Table 5.13 Road Functional Class Criticality Scales

Highway Functional Class	Criticality Scale
Local	0.1
Collector	0.3
Arterial but not NHS	0.5
National Highway System (NHS)	1.0

5.1.6.2 Assessing Corridor Exposure-vulnerability

Fundamental to effective risk management are the concepts of vulnerability and exposure. Primarily, decision makers conscious about risk management are interested in knowing how exposed and vulnerable they are to a certain looming threat. As such, analyzing risk without effectively accounting for these terms weakens the credibility of the risk results. For this reason, corridor exposure and vulnerability to threats (asset failure) were estimated as one element of the terms characterizing risk. Due to the significant differences in data completeness, different approaches were established for each case study to assess this index. Reasonable assumptions were adapted to complement the available data.

Each corridor was assessed for its exposure and vulnerability to failure for a given threat. Individual threat vulnerability was then combined with the corridor's exposure factor to obtain the overall exposure-vulnerability index for the corridor. In effect, a DOT can evaluate a network by first assessing a corridor's vulnerability with respect to a single threat or a combination of all the threats within the corridor. Table 5.14 and Table 5.15 explain the exposure-vulnerability descriptions and the scale factors used in assessing corridor vulnerability to individual threats.

Some of the categorizations were used across all case studies while other scales were developed uniquely for case studies due to data restriction. For instance, Table 5.14 was employed for assessing ODOT culverts and ERS. Due to the absence of overall condition or deterioration information, the reasonable information available to assess culvert and wall vulnerability to failure was the date of installation. As such, it was established that a corridor which has more than 70% of its culverts exceeding 70% of their service life will have higher vulnerability to experiencing a loss due to a culvert failure. Similar categories were developed

for different levels of vulnerability. For DOTs that provided general asset conditions, it was assumed that corridors that have higher percentage of worse-conditioned assets are likely to have high vulnerability to failure. Consequently, using the threat (asset or hazard) vulnerability previously developed in phase one, corridor vulnerability scales were assigned. In practice however, decision makers can employ dissimilar vulnerability range classification to emphasize their attitude towards risk.

Table 5.14 Corridor Vulnerability Scales: Assets with Installation Year

Vulnerability Description	Vulnerability Factor
Less than 30% of walls/culverts has passed 70% of service life	0.1
Between 30 and 50% walls/culverts have passed 70% of service life	0.3
Between 50 and 70% walls/culverts have passed 70% of service life	0.5
More than 70% walls/culverts have passed 70% of service life	1.0

Table 5.15 Corridor Vulnerability Scales: Assets with Condition Information

Vulnerability Description	Vulnerability Factor
% of low vulnerable assets is greater or equal to 70%	0.1
% of low plus % of medium vulnerable assets is greater or equal to 70%	0.3
% of low plus % of high vulnerable assets is greater or equal to 60%	0.5
% of high vulnerable assets is greater than 50% or % of medium plus high vulnerable assets is greater or equal 70%	1.0

For all the corridor alternatives in the pool, after the corridor criticality and exposure-vulnerability indices were assessed, the two indices were combined into a single overall risk score. Again, in this aggregation process, one may emphasize one component more by assigning weights to reflect their preference. For simplicity, equal weighting was used in this study.

Following this process, all the alternative corridors were relatively ranked and the results analyzed. Section 5.2 presents a discussion of the results and the implications of the results to policy development and decision making.

5.2 Discussion of Case Study Results

This section presents the three case study results ensuing from the application of the HARM-DSS framework described in chapter four, and the developed risk criteria factors in section 5.1. The subsections detail results on asset vulnerability, corridor vulnerability to individual threats (asset failure or hazard occurrence), corridor criticality, corridor exposure-vulnerability, and corridor overall risk score. It is imperative to note that these results are only relative for a given DOT. Consequently, there is no intention or value in comparing results among case study DOTs. Three overarching deductions emerged from analyzing the case studies.

- There is the need for Federal commitments or mandates to develop standards for gathering highway ancillary assets inventory and inspection data, and assessing asset vulnerability. Such commitments and mandates can help with comparisons of DOTs among each other; especially, for the purpose of identifying potential states for federal funding allocation similar to the benefits the NBI system offers.
- In the absence of quality and complete data, if DOTs can find reasonable means to assess threat vulnerability to implement the HARM-DSS, the results from the analysis can provide valuable information for better maintenance prioritization as well as asset and corridor monitoring that can offer greater cost savings by avoiding emergency repair costs.

- An integrated approach to highway asset management, addressing the needs of ancillary highway assets, promises to enable DOTs continue to offer uninterrupted operations to network users.

5.2.1 Minnesota Department of Transportation

Generally, the outcome of the overall risk score was consistent with the anticipated results. Figure 5.1 shows that for corridors with comparable criticality index, the overall risk score was driven by the exposure-vulnerability index. Similarly, for corridors with comparable exposure-vulnerability index, the overall risk score was differentiated by the criticality of corridors.

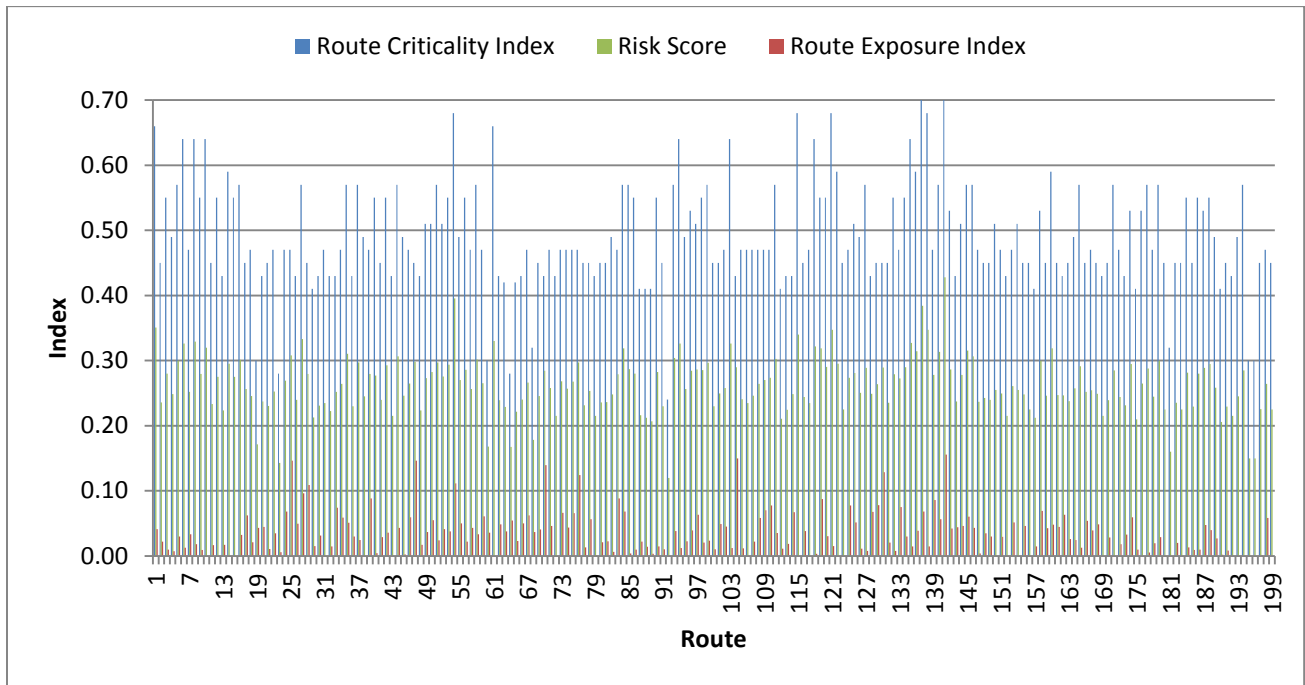

Figure 5.1 MnDOT Distribution of Corridor Risk Elements

Figure 5.2 shows the distribution of asset category vulnerability. The results show that MnDOT has very high performing overhead-sign structures. In other words, only 3% of overhead signs in the database were categorized to have medium and high vulnerability. In fact,

none of the sign structures has a high vulnerability level. This observation implies that 3% of the sign structures were under “review”. The remaining 97% of sign structures in the study area were categorized as having low vulnerability. Again, majority of the sign structures were classified as “Good”.

This observation can be attributed partially to Federal mandates that require DOTs to maintain minimum standards for sign infrastructure. Although the mandate emphasizes retroreflectivity of signs, many DOTs are similarly concerned with the structural integrity of signs as well. In the case of culverts and plate-beam barriers, 11% and 20%, respectively, were found to have high vulnerability. This observation implies that 11% of MnDOT culverts within the study area were ranked as poor or very poor. These culverts are deteriorated or have serious deterioration and need consideration for repairs.

Figure 5.2 also shows that 73% of culverts were categorized as medium vulnerability (i.e., these culverts have fair conditions with some wear, but are structurally sound) and the remaining 16% as low vulnerability (i.e., like new). Finally, 53% and 27% of plate-beam barrier were categorized as medium and low vulnerability, respectively. That is, 53% of the items in the database have experienced some hits and need to be fixed but are still functional. Whereas 27% of the barriers only had cosmetic defects (hits or rust that does not need to be fixed), the remaining 20% were found to be non-functional or with broken end treatment.

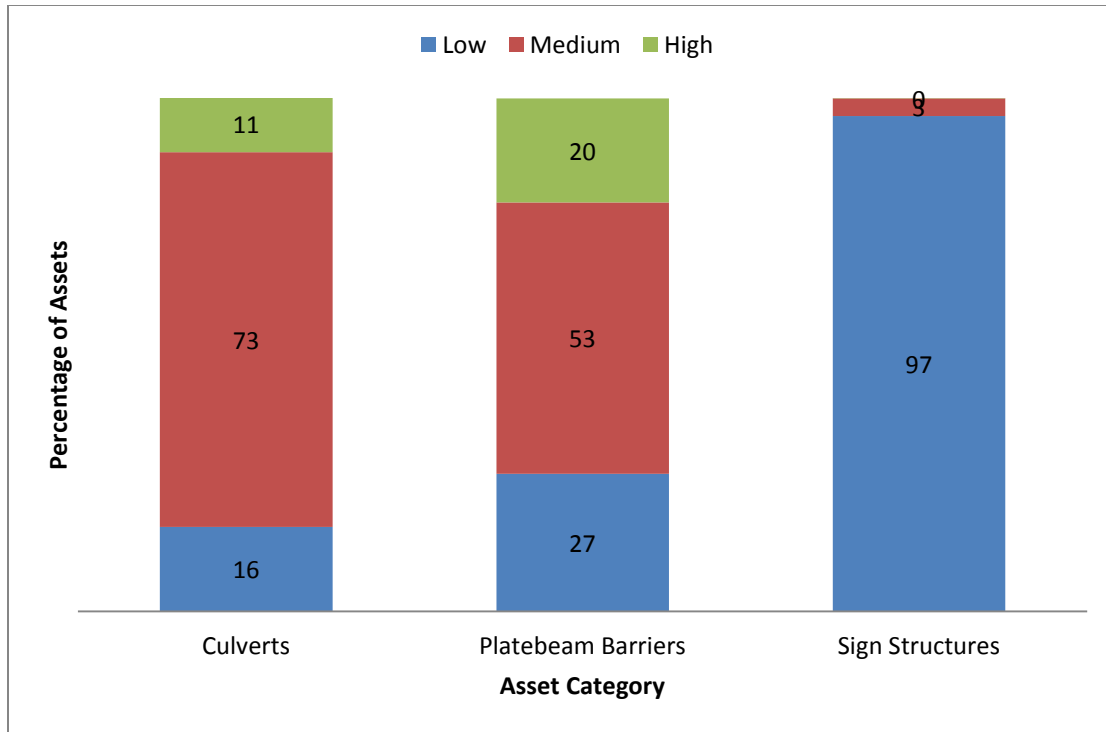

Figure 5.2 MnDOT Asset Category Vulnerability Performance

Figure 5.3 shows the percentages of corridors vulnerable to a given asset category or threat. The general observation is that very small percentages of corridors are highly vulnerable to any given threat. In fact, only 5, 4, and 2% of the corridors were identified to be highly vulnerable to culverts, plate-beam barriers, and overhead-sign structures, respectively. This observation was not surprising since very small percentages of assets were identified to show high vulnerability in Figure 5.2. For instance, more than 50% of the corridors were identified to show low vulnerability to plate-beam barriers. Similarly, 68% of the corridors were identified to have medium vulnerability to culverts failure. This observation shows that most of MnDOT culverts were ranked as low or medium vulnerability, which is consistent with the observations made in Figure 5.2.

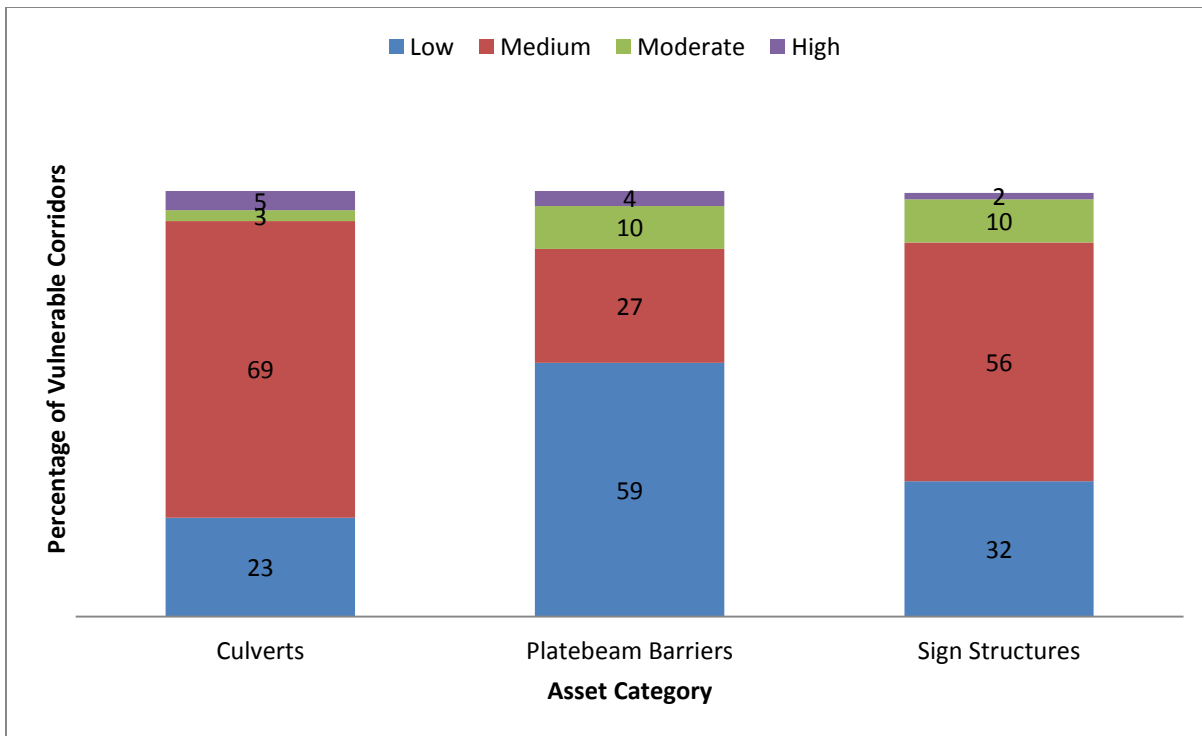

Figure 5.3 MnDOT Corridor Vulnerability Based on Asset Category

Further, Figure 5.4 shows percentage categorization of corridors based on corridor risk elements: corridor criticality, exposure-vulnerability, and overall risk score. Over 90% of the corridors were categorized between low and medium risk. This observation is attributed to the fact that almost 80% of the corridors were ranked between low and medium corridor exposure-vulnerability. It was not surprising to see only 1% of the corridors classified as high risk. Notably, even though 30% of the corridors were identified to be highly critical due to high functional classification, high truck volume and expected traffic growth, and long detours, a very small percentage (7%) of the corridors was identified to exhibit high corridor exposure-vulnerability scores. Figure 5.5 to Figure 5.7 show corridor locations and their relative performances in criticality, exposure-vulnerability, and overall risk scores. Appendices E.1 to E.3 show corridor locations and their relative vulnerability to failure for each threat category.

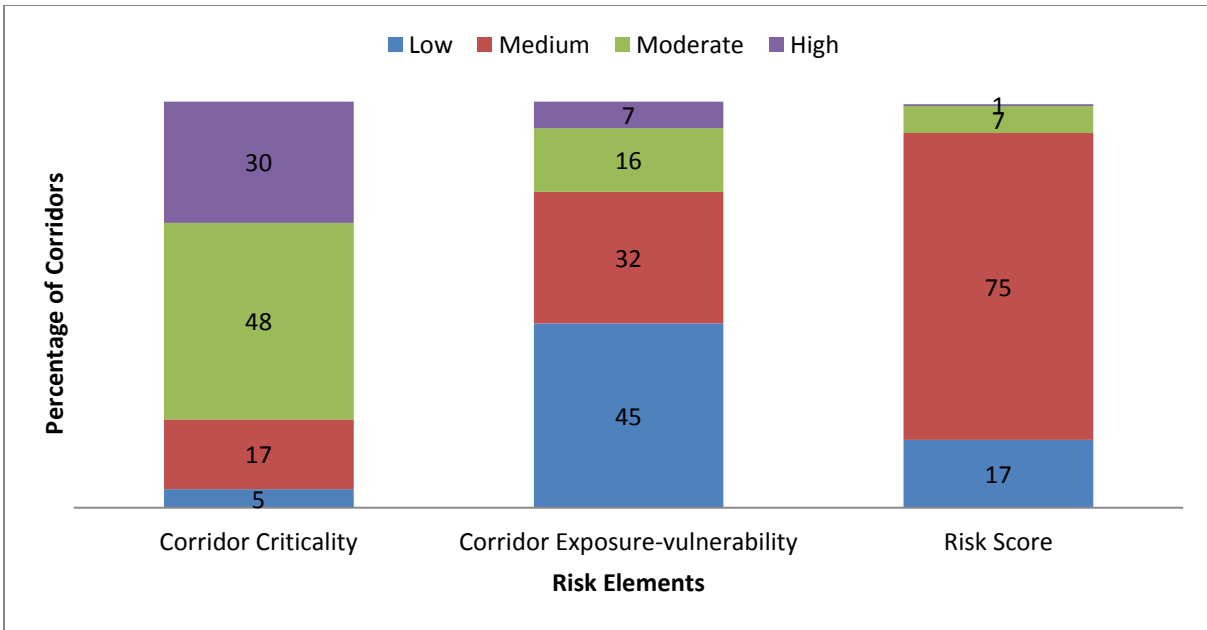

Figure 5.4 MnDOT Corridor Risk Elements

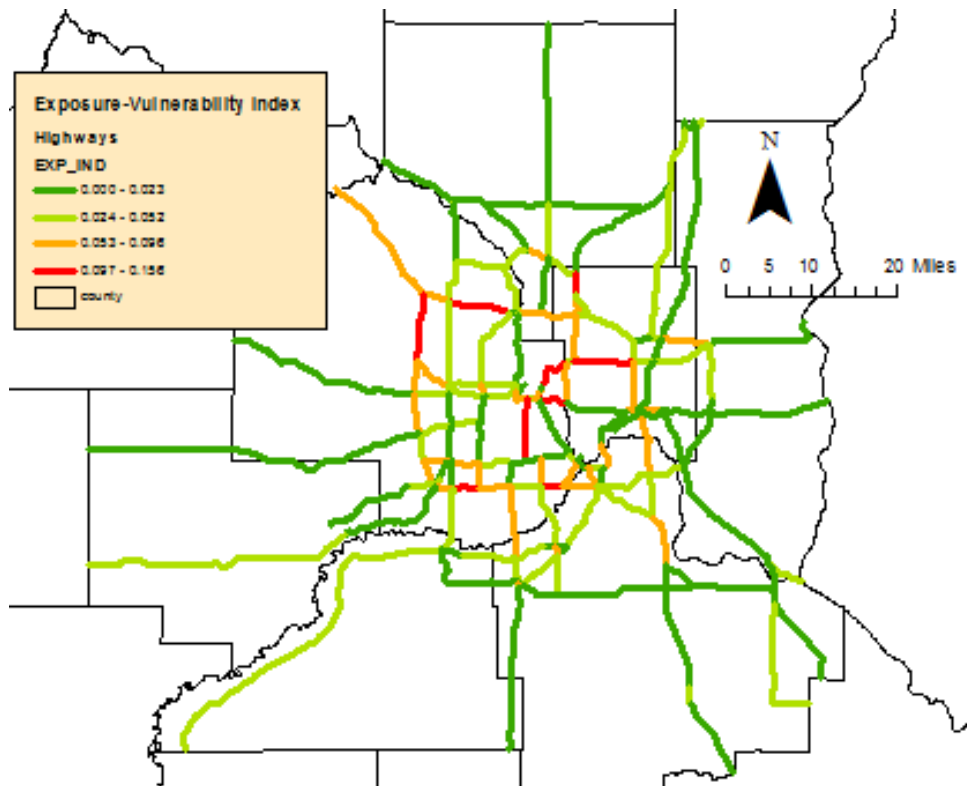

Figure 5.5 MnDOT Corridor Exposure-Vulnerability Index

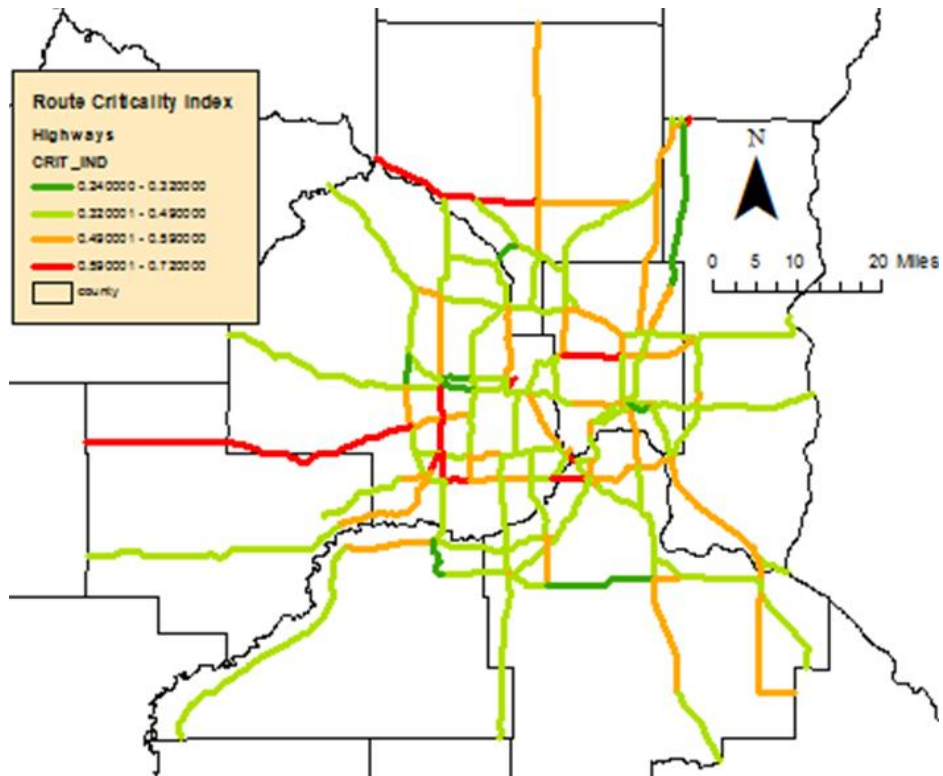

Figure 5.6 MnDOT Corridor Criticality Index

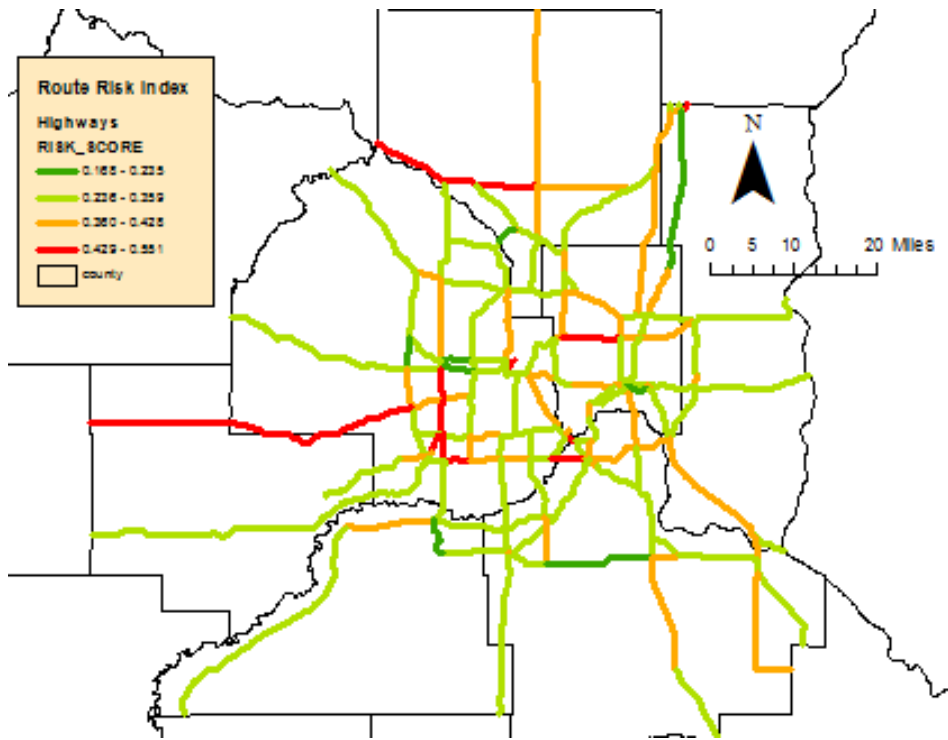

Figure 5.7 MnDOT Corridor Overall Risk Index

5.2.2 New York State Department of Transportation

This section discusses the results ensuing from NYSDOT's analysis. The section includes graphs and maps showing the relative performance of corridor alternatives that may be targeted for investment or monitoring. Figure 5.8 shows the distribution of corridor criticality, exposure-vulnerability, and risk scores. The general observation is very intuitive. Generally, corridors with relatively high criticality index and exposure-vulnerability index consequently exhibit relatively high risk. Primarily, the risk score of corridors with no exposure-vulnerability is directly proportional to the criticality of the corridor. This prevents DOTs from categorizing a corridor as having zero risk.

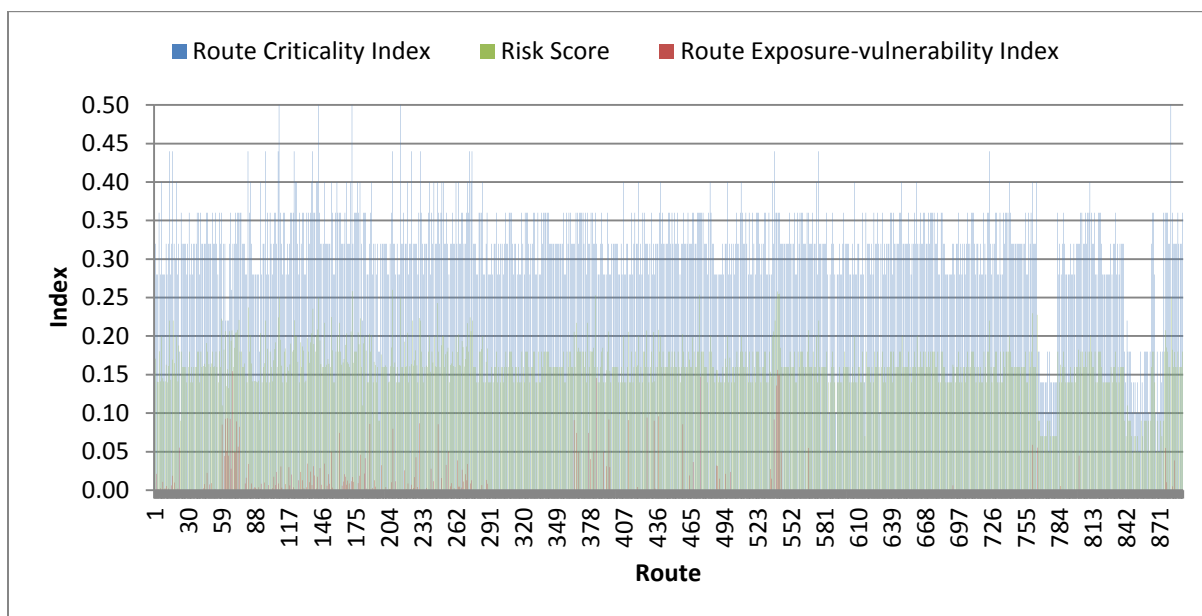

Figure 5.8 NYSDOT Distribution of Corridor Risk Elements

Figure 5.9 shows the percentages of asset category (threat) vulnerability levels. Figure 5.9 indicates that 58% of culverts within the study area have medium vulnerability to failure. This observation suggests that 58% of the culverts in the study area were classified to have culvert recommendation scale of 3 and/or 4. That is, these culverts have caused settlement to the

pavement or may require extensive work due to deterioration of wingwalls and/or headwalls (see Table 5.7). Furthermore, 13% of the culverts were classified to have high vulnerability to failure. The implication of this observation is that these culverts were assigned a culvert recommendation scale of 1 and/or 2. As such, these culverts may require replacement due to serious deformation and settlement of the structure. These culverts may also show signs of imminent collapse. Additional unfavorable conditions may also exist (see Table 5.7).

Finally, 29% of culverts were classified as exhibiting low vulnerability of failure. This classification indicates that close to 30% of the culverts were assigned a numerical recommendation scale of 5, 6, and/or 7 during the culvert inspection and rating process. These culverts are identified as requiring no repairs, requiring minor repairs to pavement or shoulder, or requiring minor removal of light vegetation (see Table 5.7).

Similar insinuations can be made from Figure 5.9 for guardrails. Over 60% of the guardrails were identified to have high vulnerability to failure. This implies that over 60% of the guardrails were classified in the scale rating of 1 to 3 (see Table 5.9). On the other hand, 28% and 9% were classified as low and medium vulnerable, respectively. These observations imply that close to 40% of the guardrail runs were identified as new or with minor aging/deterioration.

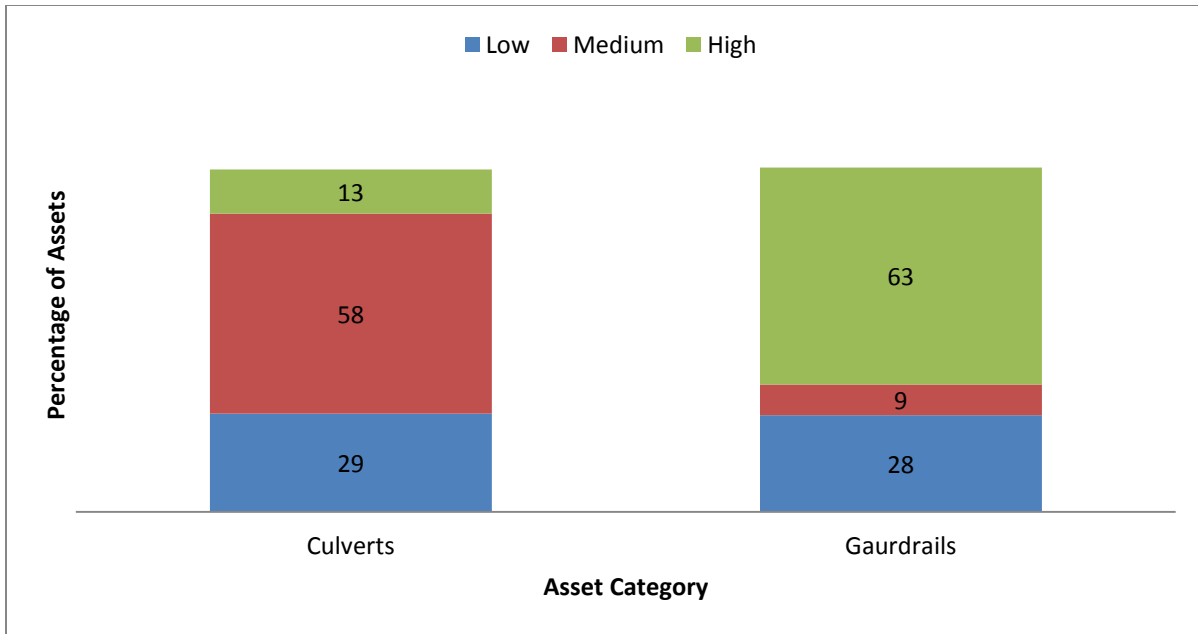

Figure 5.9 NYSDOT Asset Category Vulnerability Performance

Figure 5.110 and Figure 5.121 compare the percentages of corridor vulnerability levels attributed to a given threat or asset category and percentage of corridors identified for each level of risk element, respectively. Figure 5.10 shows that 85% of the corridors have low vulnerability to culvert asset failure and 12% have medium vulnerability to culvert failure. This observation suggests that more than 70% of the culverts on these corridors were classified to have a medium vulnerability to failure. This inference is consistent with the observation made in Figure 5.9. That is, 87% of the culverts were identified to have low to medium vulnerability to failure. This means that majority of culverts on these corridors had a general condition of numerical scale 3-7 (see Table 5.7).

Only 3% of the corridors were identified to have moderate to high vulnerability to culvert failure. This suggests that, the 13% of culverts classified to have high vulnerability to failure in Figure 5.9 were widely-spread over the study area. Accordingly, this limited the percentage of highly vulnerable culverts over a given corridor to a minimum and reduced the vulnerability of

corridors to failure. In fact, only 1% of corridors were identified to exhibit high vulnerability to failure. This implies that, for this 1% of corridors, the sum of culverts with high and medium vulnerability to failure is greater than or equal to 70%, or more than 50% of the culverts located on these corridors have high vulnerability to failure. In the case of guardrails, the majority of the corridors were identified to have low vulnerability to failure.

This finding was not consistent with what was observed in Figure 5.9, in which about 60% of guardrails were identified to have high vulnerability to failure. Nonetheless, it can be concluded that these highly vulnerable guardrails were not concentrated, but widely spread out over corridors in the entire region. That is, there were very few corridors that had 50% or more of the guardrails located on them to have a categorization of high vulnerability, or there were very few corridors that had 70% of all guardrails to fall within medium and high vulnerability. These results demonstrate the importance of the spatial component in integrated corridor analysis as the spatial distribution of the asset and hazard conditions and influence system performance in a non-trivial manner.

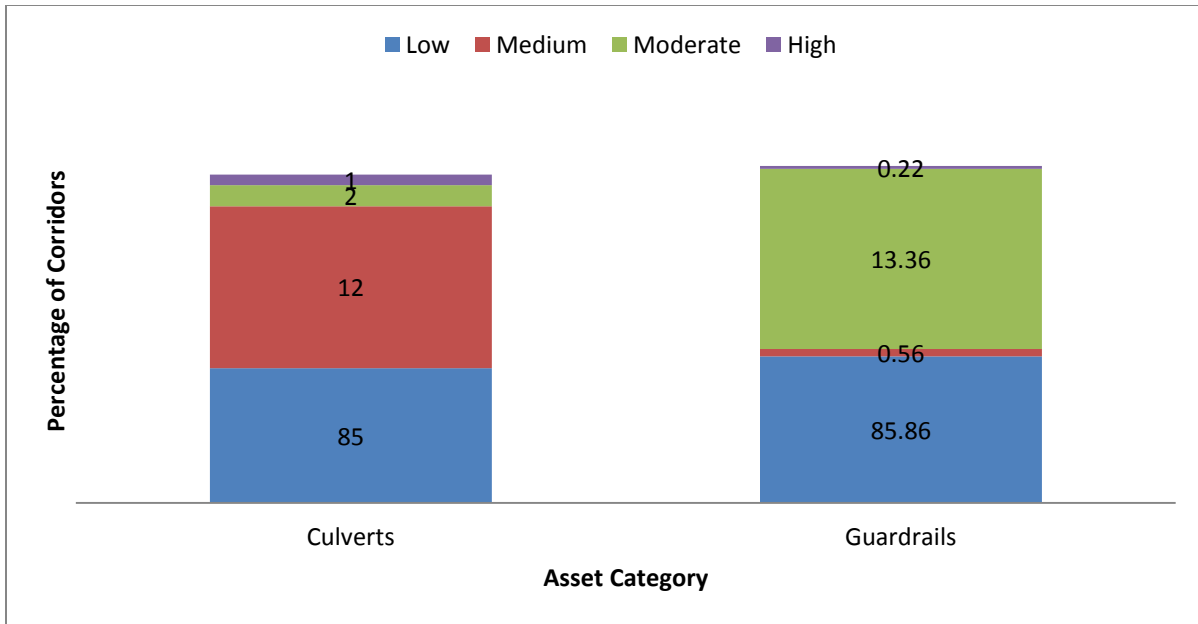

Figure 5.10 NYSDOT Corridor Vulnerability Based on Asset Category

Figure 5.11 illustrates the percentage of corridors within each category scale of the risk elements. Over 70% of the corridors were classified as being of moderate to high criticality. This classification signifies that most of the corridors are of higher functional class, and have high traffic growth, or longer detour lengths. Majority (86%) of the corridors were classified to have low exposure-vulnerability index. This scenario is consistent to the observation made in Figure 5.10. Since nearly 85% of the corridors were identified to have low vulnerability to culvert and guardrail failures, it is not a surprise to have 86% of the corridors falling in the lower category of corridor exposure-vulnerability index. Consequently, over 60% of the corridors were classified as low and medium risk, and only 7% classified as high risk which is mostly influence by the 7% corridors that were classified as having high corridor criticality. Figure 5.12 shows corridors with highly ranked exposure-vulnerability to culverts and guardrails. This figure enables decision makers to quickly identify highly vulnerable corridors for further analysis, intervention, or better budget planning. Figure 5.13 to Figure 5.15 show corridor locations and their relative performance in criticality, exposure-vulnerability, and overall risk scores.

Appendices F.1 to F.3 show geographic locations of corridors and their relative vulnerability to failure for each threat category.

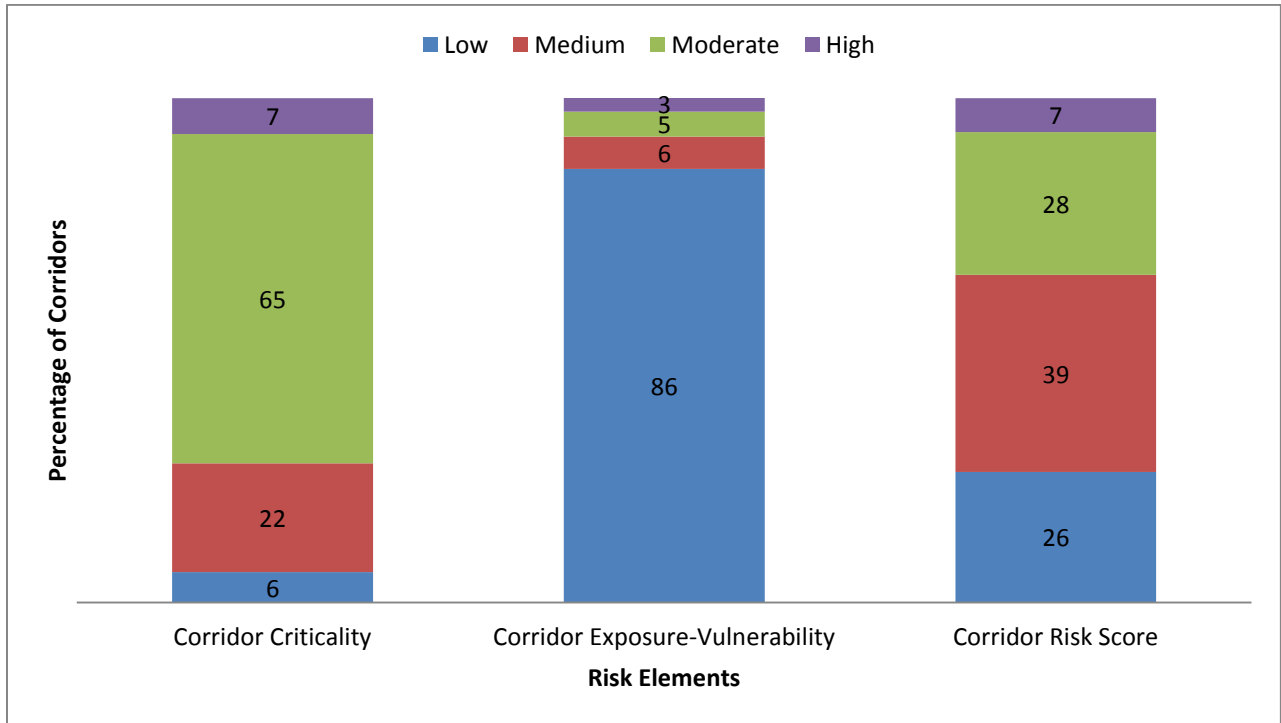

Figure 5.11 NYSDOT Corridor Risk Elements

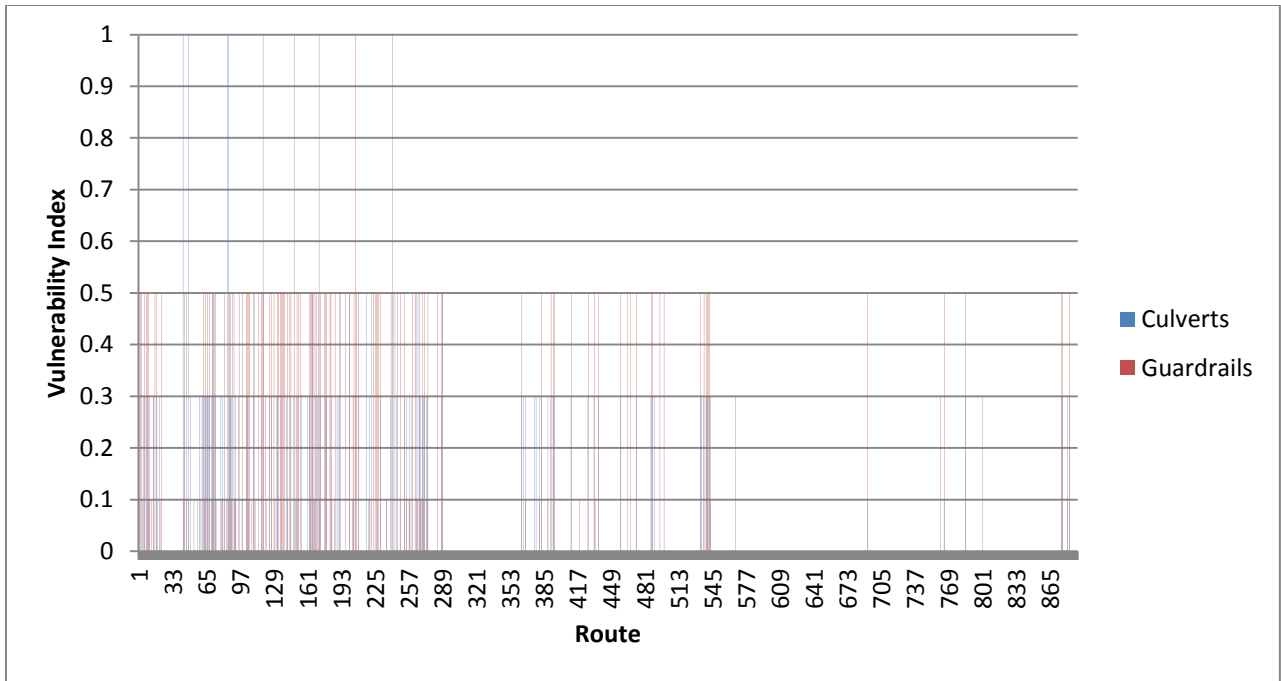

Figure 5.12 NYSDOT Corridor Exposure-Vulnerability Distribution

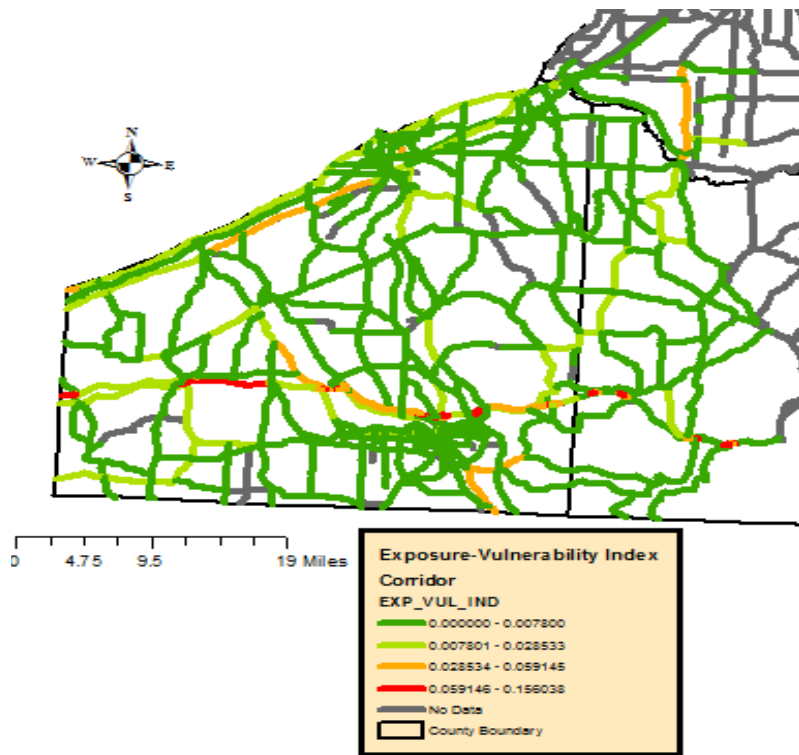

Figure 5.13 Section of NYSDOT Region 5 Corridor Exposure-Vulnerability Index

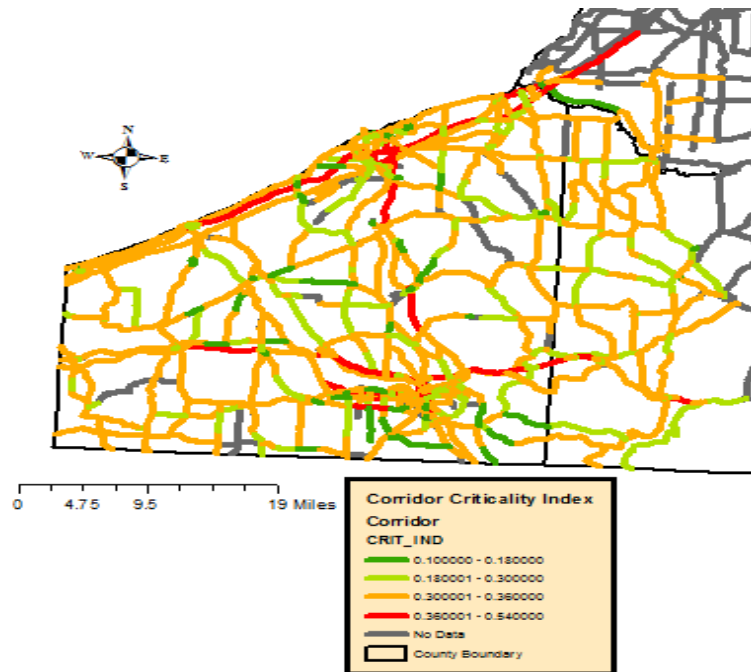

Figure 5.14 Section of NYSDOT Region 5 Corridor Criticality Index

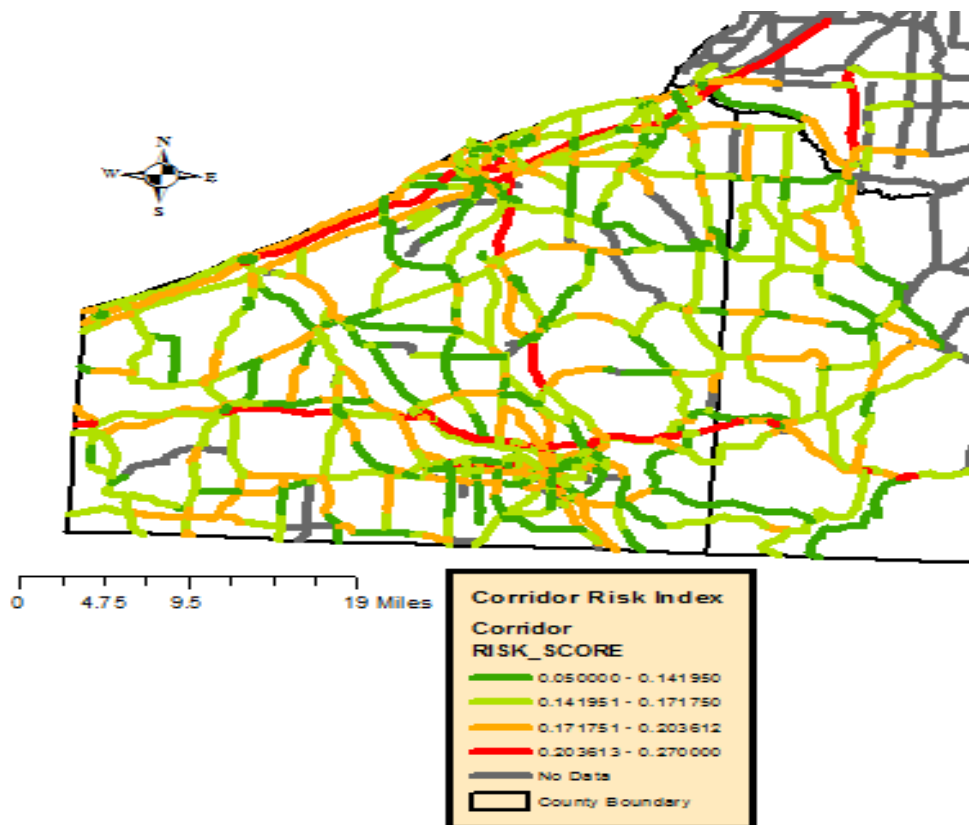

Figure 5.15 Section of NYSDOT Region 5 Corridor Risk Index

5.2.3 Oregon Department of Transportation

This section presents some outputs resulting from analyzing data from ODOT. The outputs are route criticality, exposure-vulnerability, overall risk indices, and percentage of corridors vulnerable to a given threat, for each vulnerability level. Figure 5.16 shows the distribution of corridor risk elements. The graph shows that the key driver factor to the overall risk score was corridor criticality. This is because in this case study, most of the corridors exhibited low exposure-vulnerability scores (see Figure 5.18). In fact, Figure 5.17 shows that majority of the corridors have low vulnerability to failure with respect to all asset categories (threats). In addition, 5% of the corridors were identified to have high vulnerability to wall failure. This observation implies that 70% of the walls located on these alternative corridors have reached or exceeded 70% of their service life.

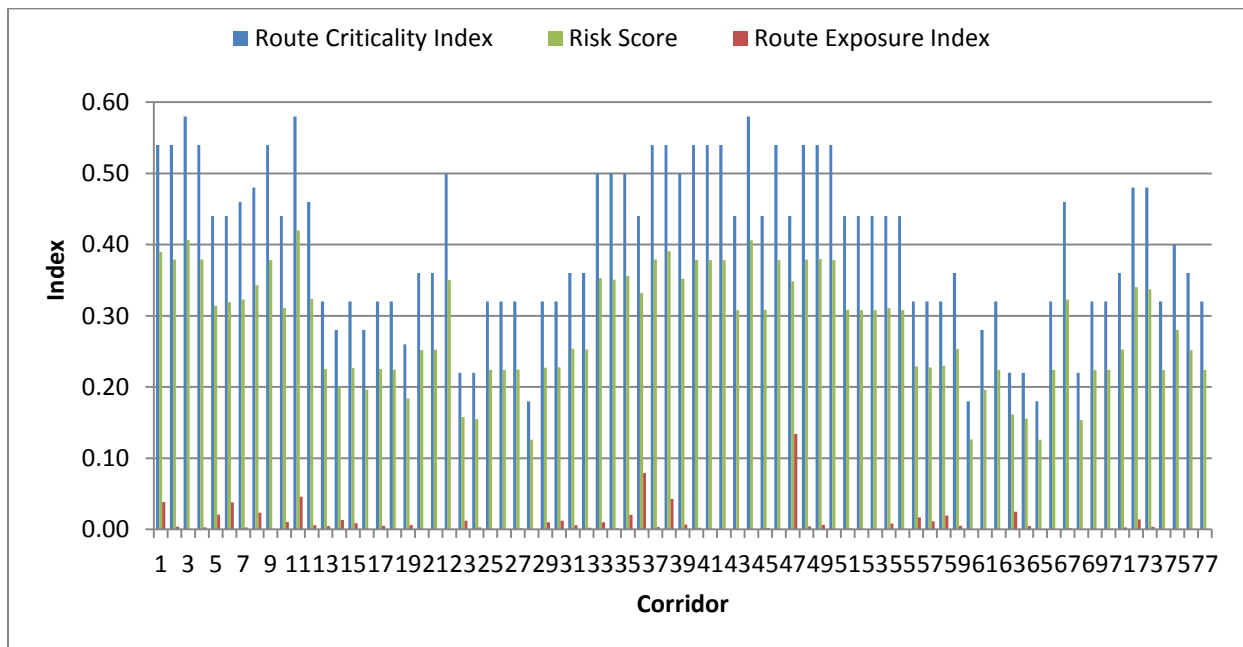

Figure 5.16 ODOT Distribution of Corridor Risk Elements

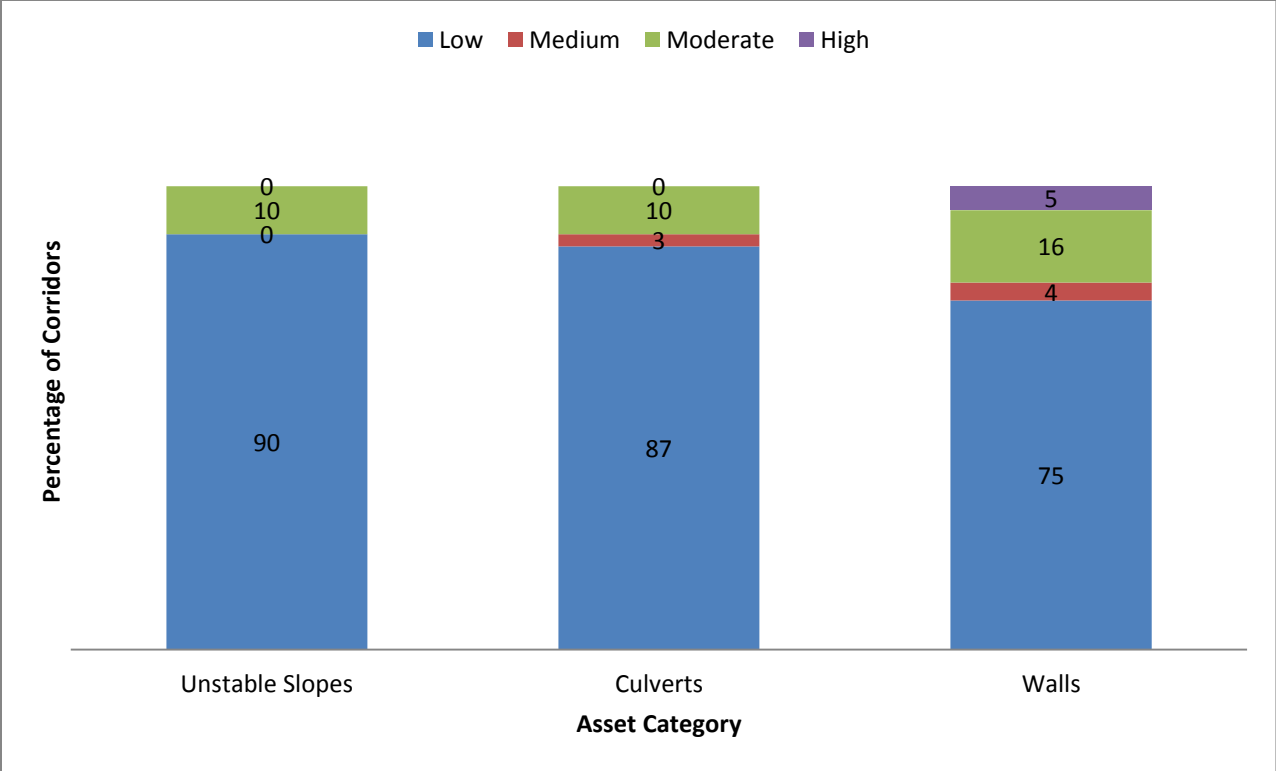

Figure 5.17 ODOT Corridor Vulnerability Based on Asset Category

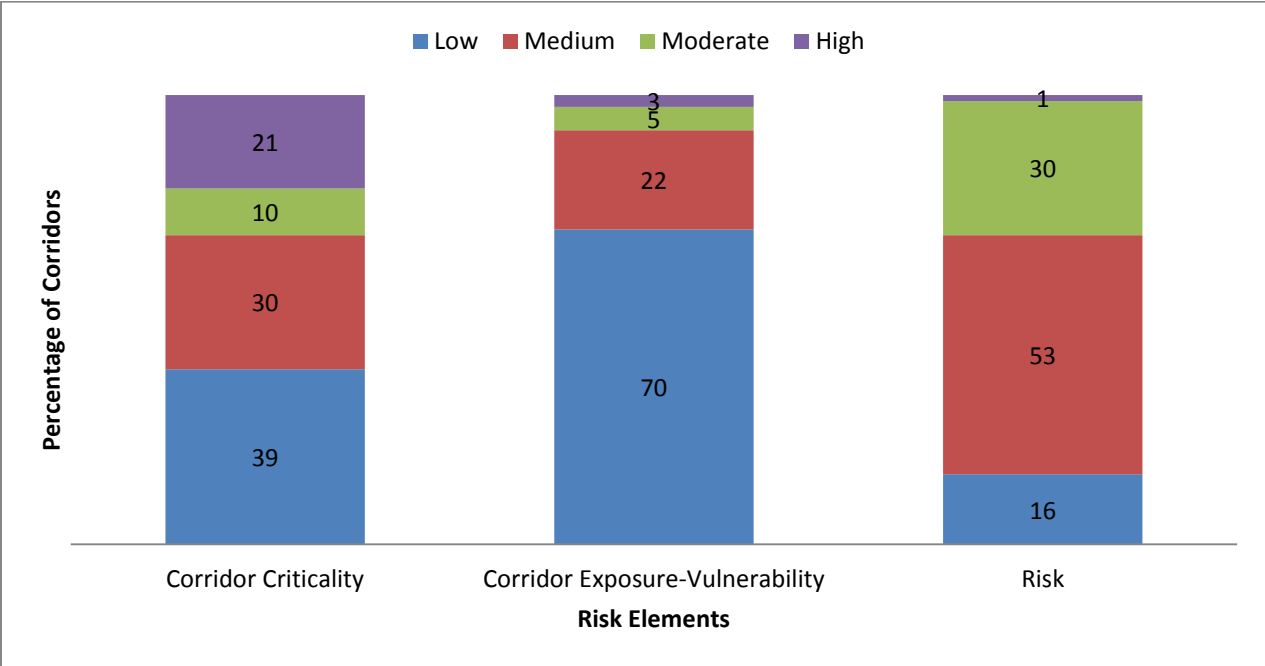

Figure 5.18 ODOT Corridor Risk Elements

Figure 5.19 gives DOTs a tool to quickly identify corridors exhibiting unusual performance relating to vulnerability to an asset or hazard class failure. For instance, an agency can quickly identify the corridors in the network showing high vulnerability to ERS failure in Figure 5.19. Having this information, such as about 70% of ERS located on these corridors have reached or exceeded 70% of their service life, informs an agency in their emergency preparedness plan if such information is not readily used in budget planning. In addition, Figure 5.20 and Figure 5.21 show heat maps of the study area indicating how relative scores of corridor exposure-vulnerability and risk are distributed. These geographic representation outputs offer decision makers the sense of spatial distribution of problem areas. Appendices G.1 to G.3 show geographic locations of corridors and their relative vulnerability to failure for each threat category.

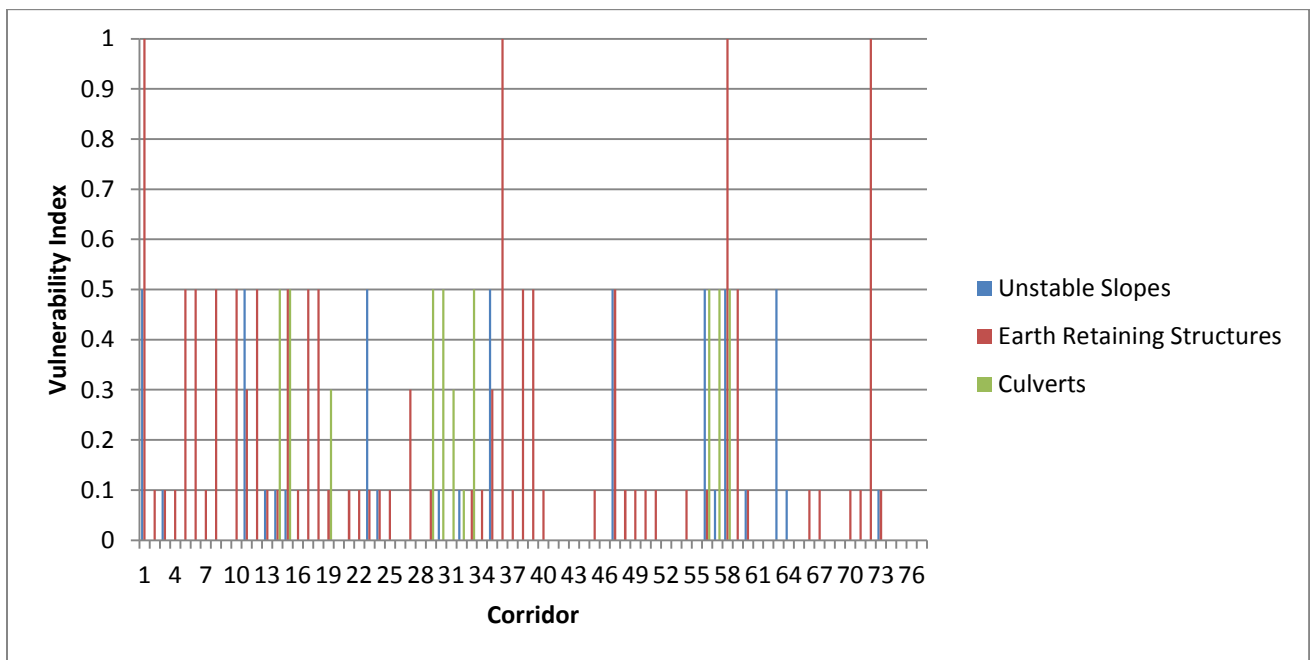

Figure 5.19 ODOT Corridor Exposure-Vulnerability Distribution

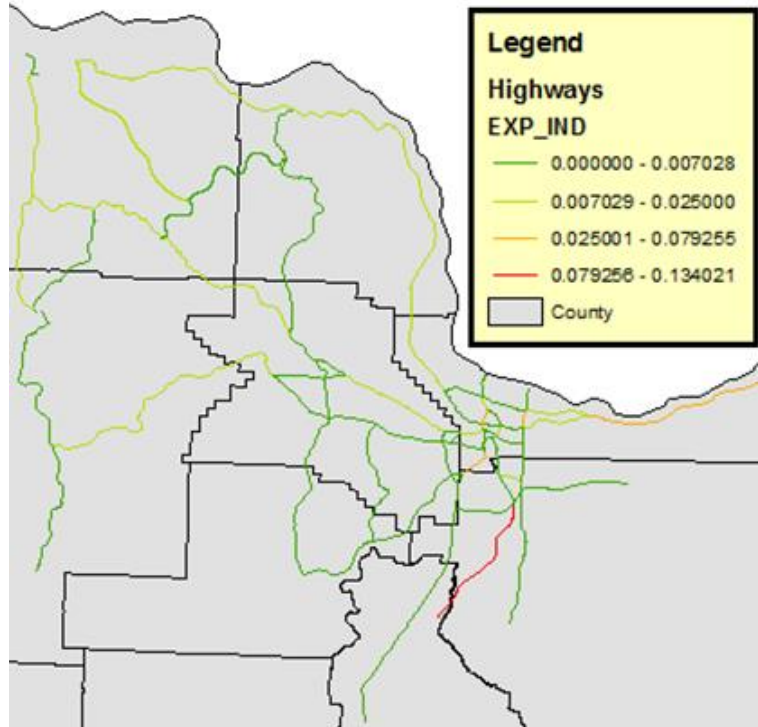

Figure 5.20 ODOT Corridor Exposure-Vulnerability Index Heat Map

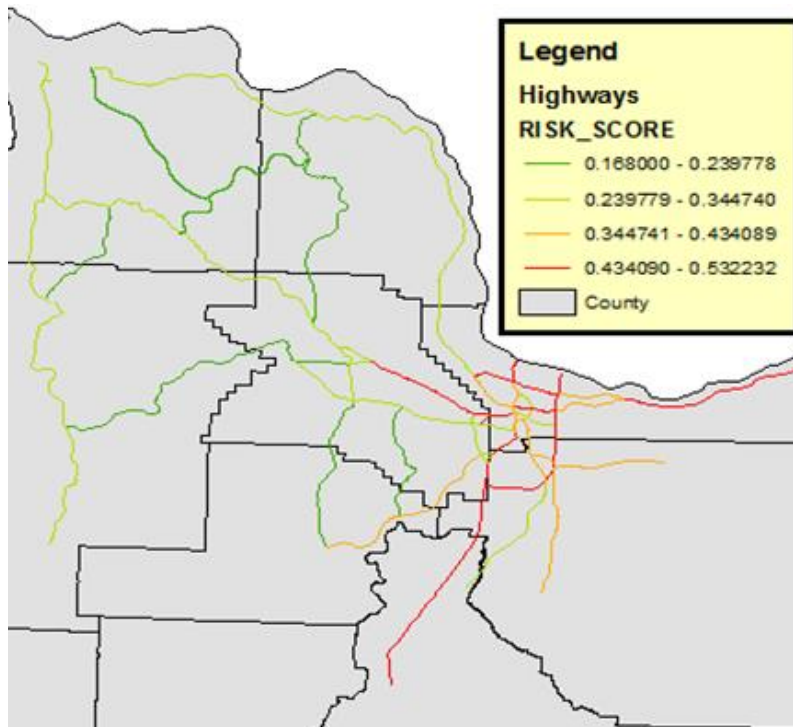

Figure 5.21 ODOT Risk Score Heat Map

5.2.3 Sensitivity Analysis

As discussed in Chapter four, sensitivity analysis provides decision makers and analysts the ability to vary data inputs and analyze the effects on outputs. This procedure allows decision makers to identify key driving variables (e.g., asset or hazard category or segment of a corridor) in the decision analysis process. For instance, if after the completion of risk assessment process, decision makers want to identify the most influential category of asset that will help reduce the overall exposure-vulnerability index of a corridor, it is possible to vary the inputs (corridor vulnerability to failure index with respect to a given asset class), observe the outputs (corridor overall exposure-vulnerability index), and identify the most influential class of assets or hazards.

Figure 5.22 exemplifies a sensitivity results for MnDOT data. Figure 5.22 shows the effect that each asset category has on the overall exposure-vulnerability of a corridor. The results show that, for a given corridor, increasing corridor vulnerability to sign failure to the next worse vulnerability level will result in the greatest exacerbation of the overall exposure-vulnerability. With this information, decision makers can develop policies that ensure that corridor vulnerability to sign failure does not increase above the current condition. Similarly, in reducing corridor vulnerability to any asset class failure, culverts offer the greatest improvement benefits to the overall exposure-vulnerability.

The figure shows that any change in the vulnerability level for platebeam will not notably increase the overall corridor vulnerability. This confirms that platebeam vulnerability is at its worst performance currently. As such, this is an asset class area that will require immediate attention. However, reducing its vulnerability does not return significant benefits to the overall corridor exposure-vulnerability. This information helps decision makers to free up resources for other areas in the network. Also, Table 5.16 demonstrates how decision makers can identify

corridors with highest risks in the event that the exposure-vulnerability of these corridors increases by 50%. The sensitivity analysis shows that the corridor with a 0.3493 SR will experience the greatest risk. Consequently, decision makers can emphasize this corridor in policy development and budgetary planning.

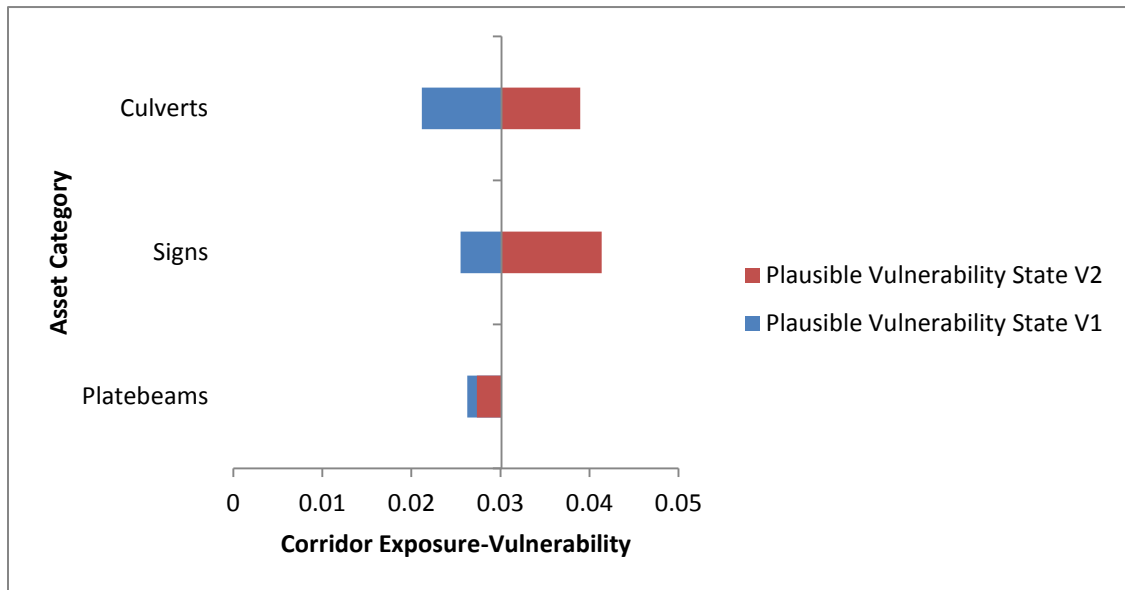

Figure 5.22 Sensitivity Analysis: Asset Class Vulnerability Influence on Overall Corridor Exposure-Vulnerability

Table 5.16 Sensitivity Analysis: Different Corridor Alternatives

For given corridor alternatives (Increase Exposure-Vulnerability by 50%)					
Corridor	Exposure-Vulnerability Index		Risk Score		SR
	Initial	Final	Initial	Final	
US Highway 10_seg1	0.013	0.020	0.452	0.454	0.0077
US Highway 169	0.033	0.050	0.339	0.344	0.0296
US Highway 10_seg11	0.018	0.027	0.453	0.529	0.3493
State Highway 65	0.009	0.014	0.388	0.389	0.0071

5.2.4 Policy Implication

The introduction, implementation, and enforcement of some aspects of MAP-21 will lead to risk-based planning and programming in State DOTs. DOTs will need to establish this formal planning procedure to meet the requirements of the 2012 surface transportation bill. Primarily, DOTs will need to develop and implement pragmatic risk frameworks and models that can assist them in achieving their objectives. The framework and models presented in this research are mainly practical examples of decision-informing tools for capital budgeting, not necessarily asset-specific assessment tools for prioritizing assets. However, the tools make provision for this task to be accomplished with limited assumptions. If a DOT can successfully implement this risk-based decision-support management system, the agency will not only position itself to fulfill the requirements of MAP-21 and avoid any undesirable actions from the Federal government, but will also benefit from utilizing the approach as a platform for identifying imminent risks in the transportation network. These actions can lead to making optimal investment decisions, providing better accountability to the public, and monitoring resulting effects, which serve as a way to address system resilience and reliability.

As a result of other factors (challenging to account for) that affect the outcome of risk assessment procedures, the resulting outputs in a risk analysis program may not reflect accurate estimates of true network vulnerability and risk; however, the ensuing outcome can still generate useful information for decision-makers in policy development and selection. Similarly, decision-makers can improve organizational business and operational procedures through the use of such results. Further, the benefits of this research include, but are not limited to: converting DOTs' asset information systems into a decision-support or asset management system, identifying corridors with high vulnerability to failure with respect to a given category of asset, estimating corridors' exposure-vulnerability, corridors' criticality, and corridors' overall risk score. This information is useful in scoping and budgeting future investment programs based on infrastructure condition and future federal or state funding, allowing for better planning of maintenance and preservation activities.

Consequently, with the results presented in the previous section (section 5.2) available to DOTs or decision makers, the risk of failure of a corridor—due to asset categories selected by a DOT for systematic management—can be reduced by adopting specific risk mitigation strategies. With the aforementioned information, a corridor's risk to failure can be mitigated if a DOT or decision makers adopt one of the following risk reduction strategies:

- Identify corridors with highest overall risk scores and prioritize for risk reduction. This action may target corridors with both highest criticality and highest exposure-vulnerability scores.
- Identify corridors with highest exposure-vulnerability scores for programming. This prioritization process gives priority to corridors that are highly exposed and vulnerable to the threats (asset or hazard class) under consideration.

- Identify corridors with greatest risk reduction as a result of reducing all corridor vulnerability by a certain percentage (sensitivity analysis). This action targets corridors that show highest risk reduction ensuing from investing similar amounts of resources in all available alternative corridors to address corridor exposure-vulnerability (see section 5.2.3).
- Identify asset categories that offer the greatest vulnerability reduction, for a given corridor. This strategy gives decision makers the ability to identify an asset category that is most influential in reducing the vulnerability of a corridor to failure (see section 5.2.3).
- Identify corridors with highest criticality scores. This programming strategy basically directs resources to corridors with higher functional classification, higher AADT and TTP, longer detours or limited existing redundancy, and higher expected traffic growth. Adopting this strategy enables decision makers to monitor and preserve relatively important or critical corridors in the network, although these identified corridors may not have a relatively higher exposure-vulnerability score. If the corridor is identified as having no or little vulnerability, resources can be freed up for other corridors. On the other hand, monitoring such corridors will be beneficial since assets on these corridors may tend to deteriorate faster due to the initial characteristics enumerated.
- Use sensitivity results to set targets for asset category vulnerability. The sensitivity results help decision makers to identify asset categories vulnerability levels that will drive the entire corridor vulnerability. This information allows decision makers to set tolerable targets for each asset category.

Chapter 6 CONCLUSIONS, RECOMMENDATIONS, CONTRIBUTIONS, AND

FUTURE WORK

6.1 Conclusions

6.1.1 Summary

Risk-based transportation asset management is becoming a common practice among DOTs with the introduction of MAP-21, which mandates all DOTs to undertake and establish a risk-based asset management system for the NHS. In the past, practitioners have practiced risk-based decision making though they have not called it such. This is due to the lack of documentation and consistency in the processes. Prior to MAP-21, the majority of risk-based decision making in TAM was restricted to the project level. Basically, DOTs were more concerned with assessing and addressing agency's risks to project cost overruns, project schedule, and safety. In the aftermath of the passage of MAP-21 though, international practices have shown that risk-based decision making at program and organizational levels have great value. While some agencies have taken proactive steps in addressing risk at the program level, often, their actions are restricted to individual assets, programs, or systems. This approach to asset management is typically referred to as the silo, standalone, or stovepipe management. This process results in suboptimal decision making in the wake of limited funds and aging infrastructure.

This silo form of treating risk within a transportation network gives rise to unwanted risks that may emanate from unmanaged subsystems or hazards. Accordingly, a more unified framework that comprehensively and holistically considers critical subsystems and addresses uncertainties, as much as practically possible, is proposed in this dissertation. Specifically, this

dissertation develops a framework, the HARM-DSS, which adopts the concept of a system-of systems approach in analyzing and addressing risk. The framework demonstrates that dominant transportation highway features (core assets), such as pavements and bridges, are not the only sources of risk to a transportation network. However, possible failures resulting from supporting features or hazards, such as culverts, walls, guardrails, or unstable slopes (rockfall/landslide) can also contribute to an organization's risks. Hence, the need to consider these features simultaneously in addressing sources of risk within a transportation network.

In addition, the framework emphasizes that agency risks are usually multi-dimensional. As such, the most effective approach to alleviate an agency's risks requires the inclusion of multiple criteria in the risk assessment process. The consideration of multiple attributes in the risk assessment process enables the framework to capture important facets of risk that an agency may be dealing with at any given time. To assess the effectiveness and adoptability of the framework, this dissertation implements the HARM-DSS in different contexts, developing case studies with dissimilar data availability and quality. The results of the case studies demonstrate the strength and flexibility of the framework. Most noticeably, pertaining to the framework's applicability to different scenarios of asset data exhibiting dissimilar maturity levels, the results are encouraging. The results further confirmed that the framework is an effective means of providing important decision information to decision makers; especially, when dealing with limited data.

Precisely, the following conclusions can be deduced from the results of the HARM-DSS methodology case studies:

- The case study modeling validates the concepts of the framework: systematically applying the HARM-DSS principles across competing alternatives or corridors produces

descriptive and intuitive results that decision makers can use in allocating resources during the decision-making process.

- The proposed methodology has the capability of analyzing all the individual components of the risk score and their combined effects on specific alternatives under different criteria.
- Objectivity and confidence in the analysis results can be improved through the collection of asset data, such as complete asset inventory and condition data that best represent the state of the transportation infrastructure.
- The use of expert judgment or knowledge in supplementing available data remains the viable direction in implementing the framework as more and better-quality data become available.

6.1.2 Implementing the HARM-DSS

As DOTs continue to establish and implement their risk-based asset management, opportunities exist for decision makers to benefit from the different risk management programs that have been implemented throughout the United States and overseas. Certainly, many of these programs may vary, based on the needs and priorities of the implementing agency. Most especially, the geographical configuration of a DOT's network and data availability can greatly influence the approach to implementing the HARM-DSS in a decision making process. Essentially, there is certainly no one-size-fits-all approach to implementing this framework and model. However, if properly adopted as part of a decision analysis process, the framework can offer potential benefits to DOTs: for instance, preparing informed budget plans, preserving asset conditions, and mitigating the risks these assets may present to the management of the transportation network.

In fact, the flexibility of this framework is pertinent to assessing the performance and vulnerability of ancillary highway assets. Notably, there is no current standard approach in assessing the conditions of highway ancillary assets (except the retroreflectivity of signs). As such, adopting the HARM-DSS will require establishing clear and simple directions, clarified and documented by decision makers, to assess asset conditions when clear standards are lacking. The need for a condition assessment allows decision makers to distinguish between critical and highly vulnerable asset types in the preliminary stages of the framework. This vulnerability assessment goes on to inform the detailed corridor analysis. Asset vulnerability is a fundamental input to risk analysis since it relates to the susceptibility of an asset to damage or failure. On the other hand, asset criticality relates to the importance or the need for an asset to be included in a systematic framework. Specifically, asset or corridor criticality drives the priority of data collection for the given asset or corridor.

6.1.3 Considering the Synergies between Systems and Silo Analysis

One of the main objectives of this dissertation is to address the shortcomings that the silo approach to risk management presents. In effective, addressing system risks in a holistic manner. Any attempt for decision makers to address these risks from a SoS approach requires a comprehensive understanding of the system. Understanding a system thoroughly includes knowledge on how each of the categories of assets competes, conflicts, or complements others in the operation of the transportation network. Understanding these synergies enables decision makers and analysts to better identify and eventually reduce inherent risks. Regardless of the strengths and effectiveness of an integrated risk-based framework, such as HARM-DSS, one should not conclude that this framework is to completely replace silo management approaches.

However, acknowledging that both approaches are needed to complement each other can result in a more transparent, effective, and comprehensive risk management process.

Fundamentally, the results from the silo risk assessment should be used as inputs to the integrated framework and vice versa. For instance, if an integrated analysis indicates that a corridor requires urgent attention due to its vulnerability to failure, a meticulous analysis of the asset classes along the corridor will require a silo analysis. This further analysis allows one to identify the most vulnerable assets to failure and/or critical features. Analysts and decision makers can accomplish this procedure through a process of iterations between the integrated- and silo-risk analysis processes. Consequently, this decision-support system provides a reasonable, flexible, replicable, and defensible analytical approach for decision makers to make informed budget planning and resource utilization decisions.

6.1.4 Assessing Asset Vulnerability

The literature reveals a variety of contextual approaches in assessing vulnerability. Vulnerability measures a system/agency's susceptibility to incident occurrence or threat (usually with a negative implication). Vulnerability in a larger risk assessment process provides analysts with a sense of how likely it is that a system can be impacted. A systems vulnerability measure is an important element in the risk analysis process. The risk measure or estimate of a system or infrastructure is partly dependent on the susceptibility to failure of a system or infrastructure. Through the vulnerability assessment, one can estimate how likely a system or infrastructure will fail as well as the consequence resulting from the failure.

A transportation system can be vulnerable to a diverse number of threats, including the failure of individual AHA, or occurrence of rockfalls or landslides. Similarly, a transportation agency can be vulnerable to resource shortage or political threats. To address risks, one needs to

first assess the vulnerability of the threats pertaining to the system or agency. The vulnerability assessment process involves several tasks. First, one has to understand the system or agency's mission and objectives. Second is to identify any threats to the mission and objectives of the system or agency and determine how vulnerable the system or agency is to the identified threats. To properly estimate system vulnerability, one has to have a thorough knowledge of how the system is designed, operates, and deteriorates.

6.1.5 Scaling Attributes Preference

The foundation of the model used in this unified decision-support framework is the preferences of decision makers or stakeholders. Accordingly, preference scaling is an inevitable step in the framework. The ability of the framework to scale and amalgamate all relevant criteria in the decision process enables decision makers to make informed decisions in selecting alternatives. An analyst employing the HARM-DSS framework must adopt a strategy to scale the preferences of stakeholders with respect to each criterion considered in the multi-criteria problem. The scaling approach one adopts depends on many factors: data availability, experience of the analyst, value of the analysis, or available resources. This dissertation adopts the exponential value functions and direct assignment method to scale the attributes considered in the multi-criteria problem.

These two approaches are very useful in the current study because the exponential value function offers a quantitative and objective uniform scale on which individual alternatives are compared. Conversely, the direct construct or assignment process of attribute scaling adds value to the assessment process in areas of the problem in which objective data is not available. Although this may introduce subjective judgment (i.e., expert judgment) in the analysis process, documenting and consistently communicating the shortcomings throughout the analysis and the

decision-making process allow for adjustments to be made as more and quality data become available. For decision makers to effectively benefit from this DSS framework, one must understand the advantages the HARM-DSS provides, as well as the limitations that inhibit the attractiveness and potential benefits of the framework.

6.1.2 Selecting a Risk Characterization Method

The risk characterization step in the proposed framework involves the identification of a structured format that combines risk elements to obtain a quantitative expression of risk. The literature presents traditional forms and emerging strategies in the characterization of risk. Further, there are additional studies that document the strengths and weaknesses of methods researchers and practitioners have used. This work adopts a strategy that is a hybrid of traditional methods and emerging strategies. The traditional method uses probability and consequences of failure elements to characterize risk. In this method, the same concept of probability and consequence is employed; however, the method for assessing these risk elements is based on a multi-dimensional perspective. This method does not only allow decision makers to address multiple risks, but also allows analysts to employ surrogates for hard-to-come-by probability of failure, cost, and consequence data. For instance, to estimate the consequence of failure (which is referred to in the HARM-DSS as corridor criticality), the DSS uses attributes, such as AADT, TTP, and the length of detour. Similarly, to estimate the probability of failure (which is referred to in the HARM-DSS as corridor exposure-vulnerability), the vulnerability to failure of each asset category is considered, the density of features indicating the number of possible failure points and exposure are determined from the individual subsystems of asset category.

6.2 Recommendations

This dissertation has identified a few areas that can help DOTs and decision makers to maximize their potential benefits from the application of this framework. These areas include, but are not limited to, addressing data needs, developing better procedures and measures for vulnerability, developing targets, and receiving support and guidelines from the Federal government. The following sections elaborate on these areas of concern and make recommendations that can help improve the potential benefits associated with the application of this decision-support tool.

6.2.1 Data Needs

It is quite telling from practical experience that, often, quality data can lead to better results from modeling, and essentially result in better investment decision making. Although this correlation may not necessarily be linear, one can reduce the level of subjectivity or uncertainty if an analysis is solely based on objective and quality data instead of surrogates. This dissertation and other literature highlight data availability issues associated with the management of ancillary highway assets risk. Mainly because of the lack of mandates and standards that require agencies to gather such data, it has become a voluntary practice among DOTs to maintain consistent and current data (condition, cost of failure, installation data, or location) for these asset categories. However, if any meaningful results are to be gained from using this framework, there needs to be some level of asset data upon which incremental data gathering can follow.

Reasonably, from a resource perspective, it will be practically impossible for DOTs to have complete data on all of their ancillary highway assets. Nonetheless, the level of data quantity and quality of most critical assets will influence the potential benefits this framework offers decision makers. At the least, this dissertation recommends the following: first, identify critical asset categories and corridors; and, second, gather detailed data on these asset classes to

help identify highly vulnerable segments of identified critical corridors. And as resources become available, data collection can be extended to other sections or lower functional classifications of the transportation network, for system-wide analysis. Most importantly, the requisite data must be collected with a common referencing system or the ability to integrate other systems to a common linear referencing system that enables spatial analysis. This task allows for a better identification of possible failure points (infrastructure) within segments or alternative corridors under investigation.

6.2.2 Target Setting

Targets guide decision makers to measure progress or performance as well as avoid liabilities. They frame performance objectives within selected timeframes and contribute to the foundation for making informed decisions. Fundamentally, targets motivate decision makers to perceive a cause of action to eliminate an impending risk or capitalize on existing opportunity, within a designated timeframe. Specific and achievable targets can drive executive and engineering decisions in risk-based transportation asset management. However, setting targets in decision making is very challenging without rigorous analysis to justify a selected threshold. Currently, no such targets exist for estimating vulnerability of ancillary assets. However, the framework presented offers decision makers a tool (sensitivity analysis) to investigate key driving factors driving vulnerability in various areas of study. This tool provides a practical approach for decision makers to identify specific vulnerability levels that exacerbate corridor exposure-vulnerability, and thus identify where the highest expected returns are for investments. Thus the sensitivity report is recommended as a target setting tool for decision makers, and it can be used in conjunction with expert opinion.

6.2.3 Federal Commitments

As mentioned previously, the lack of consistency in data collection process within or among DOTs makes it difficult for one to acquire better information for analysis. Indeed, missing data in inspection database exacerbates data challenges that the framework faces. Addressing these issues sometimes requires mandates from the Federal government. For example, databases such as the NBI and HPMS have continuously performed well and met their goals because of Federal requirements, oversight and guidelines. As FHWA encourages DOTs to address network risks in a comprehensive manner, the need also arises for commitments and standards that will guide agencies in integrating additional management/information systems into their existing systems. Therefore, there is the need for Federal commitments or mandates to develop standards for gathering ancillary highway assets inventory and inspection data, and assessing asset vulnerability. Such commitments and mandates can help with the comparison of DOTs among each other; especially, for the purpose of identifying potential states in Federal funding allocation similar to the benefits the NBI system offers.

6.2.4 Performance Assessment

Performance modeling, measuring, and monitoring represent key aspects of any asset management system. Similarly, a key component to the successful implementation and realization of the potential benefits of this DSS is the determination of appropriate performance measures and levels to use for assessing asset vulnerability to failure. The ability to efficiently manage risks associated with the failure of these asset classes is partly dependent on the availability of better performance prediction models. In basic terms, one can only properly manage the things that one is able to measure. The lack of performance prediction models to forecast future conditions of AHA presents a challenge for DOTs or practitioners in developing

better failure likelihoods or probabilities. As such, it is important to have a consistent set of performance measures that communicate to an analyst or a decision maker the physical conditions of the asset one is assessing. Currently, the management of AHA lacks consistent performance measures that one can use as a benchmark in assessing the vulnerability of infrastructure, but for one—retroreflectivity of signs. Accordingly, it is recommended that decision makers rely on expert knowledge to develop an initial set of measures. With time, other avenues of research can be explored to evaluate and refine these measures to improve their objectivity. It is also recommended that future studies explore the development of performance prediction models that are specific to DOT’s geographic locations to study the behavior of AHA.

6.3 Research Contributions

Previous research has shown that risk management is a useful decision-support tool that enhances the practices of transportation asset management. In addition, evidence in the literature shows that researchers and decision makers have made considerable effort to manage ancillary highway assets. However, these combined efforts are usually limited to silo style of management. The present research is designed to consider risk-based asset management in an integrated manner, considering mostly ancillary highway assets. Primarily, the findings of the research add to the knowledge and understanding of the subject of risk and its application to transportation asset management. Specifically, this work demonstrates capabilities for integrated risks assessment of non-homogeneous assets and hazards (natural and artificial hazards) in a transportation system, and the value added to risk-based investment decision making. The work does not purpose to replace silo-ed risk management but has demonstrated the value of integrated and silo-ed risk management: while integrated risk management gives a breadth of view, silo-ed asset management is necessary for depth, and together both offer a more comprehensive view of

the system under consideration. In addition, this study offers three main contributions to the state of practice of transportation asset management and decision making.

First of all, the research provides a framework and methodological approach that helps decision makers to identify and prioritize classes of ancillary assets for systematic management. The HARM-DSS is a flexible tool that is able to accommodate a variety of asset data (i.e., quantitative or qualitative) to yield reasonable results. That is, the framework demonstrates the possibility of assessing risk through modified approaches. Traditionally, assessing risk requires quantitative or probabilistic functions that are not in existence or challenging to develop for ancillary highway assets. This research provides other means of addressing these challenges through the use of expert knowledge and a different characterization of risk.

Secondly, the common practice in asset management among DOTs has focused mainly on pavements and bridges, offering less attention to ancillary highway assets. This research bridges this gap by enabling DOTs and decision makers to collectively manage these assets on a corridor level. This unified corridor-level approach to risk management allows decision makers to understand the factors associated with risk decision context. In effect, the method can enable decision makers to assess the relative exposure-vulnerability of a corridor to a particular asset class failure, the relative criticality of a corridor, and the combined relative risk effect of a corridor.

Finally, the method provides additional benefits in operating and monitoring transportation network. Specifically, the flexibility provided by the method allows transportation operation managers to assess network risk on a time specific basis. Primarily, the framework is typically for policy development and budgetary planning purposes. However, this additional benefit becomes useful when one is able change the model parameters, such as timeframe, to

identify areas of the network that may be susceptible to an imminent threat. Largely, this research provides a unique practical contribution to e transportation agencies implementing the requirements of MAP-21, which mandates all DOTs to develop risk-based TAMS for the NHS.

6.4 Future Research

This section summarizes and suggests additional research that can further enhance the potential benefits offered by this research. It is important to appreciate that there should not be an end to the investigation of integrated risk-based asset management; especially, as DOTs continue to investigate reasonable ways to incorporate other classes of assets into their asset management system. It is clear from the research results, conclusions, and recommendations that much more can be done to add to the potential benefits of this dissertation. Integrated risk-based management is an effective tool when addressing highway network vulnerability to ancillary assets failure.

A major contribution of this research is the ability to incorporate the vulnerability of ancillary assets to failure into the risk-based decision process. Most of the methods used in assessing asset vulnerability and, subsequently, corridor vulnerability were based on past condition data. Though past condition data can offer good insight to future performance of an asset, it does not really capture other uncertainties. For this reason, it is recommended that future research should investigate and develop deterioration models for ancillary assets that can capture these uncertainties.

Other research areas that will help augment this study include the investigation of other external threats (systemic threats—built into the framework but not implemented in the case study) that can influence the vulnerability of an asset to failure. For instance, the effect of climate change on asset vulnerability, and how this affects the risk assessment process can offer

great information in the risk-informed decision process. In addition, a large number of the criteria used in assessing asset vulnerability were subjectively characterized. There is no doubt that subjectivity is inherent in any decision making process. Nonetheless, research that can develop criteria scales supported by established evidence or empirical data can greatly refine the results presented in this study.

Furthermore, it may be worthwhile to explore and develop additional risk criteria that are very reflective of the risks DOTs are keen to assess. Generally, this research has incorporated different risk measures. However, these measures are not exhaustive or prescribed. Further research that can define a set of measures reflective of agency's risks will improve the benefits of these initial efforts of this dissertation. Finally, decision makers are always seeking to optimize their benefits for every investment they make. As such, research that can extend this initial effort to integrate an optimization tool that considers both economic measures and decision makers preferences in selecting programs can improve the overall effectiveness of the decision making process.

APPENDIX A Examples of Ancillary Assets and Highway Hazards



Figure A.1 Overhead Road Signs and Sign Structures



Figure A.2 Example of a Cylindrical Culvert



Figure A.3 Example of a Thrie-Beam Steel Guardrail (FHWA)



Figure A.4 Examples Traffic Signals



Figure A.5 Examples of Pavement Markings and Traffic Signs



Figure A.6 Example of a Rockfall Location (Hazard)

**APPENDIX B LOCATIONS OF UNSTABLE AND MITIGATED SLOPES ALONG
WASHINGTON STATE ROUTES**

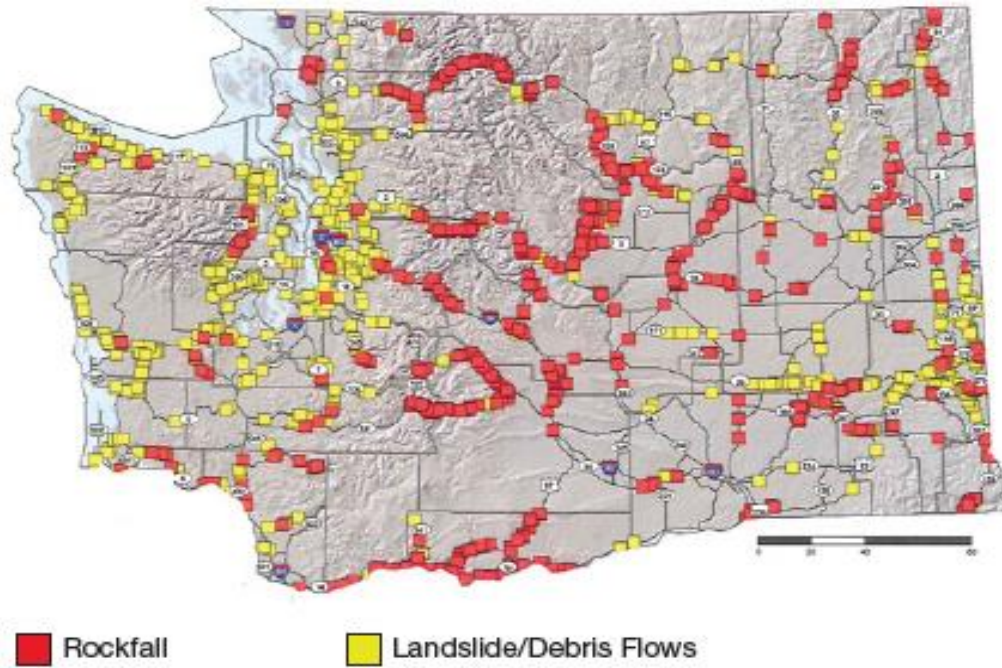

Figure B.1 Unstable Slopes along State Routes in Washington State (WSDOT, 2010)

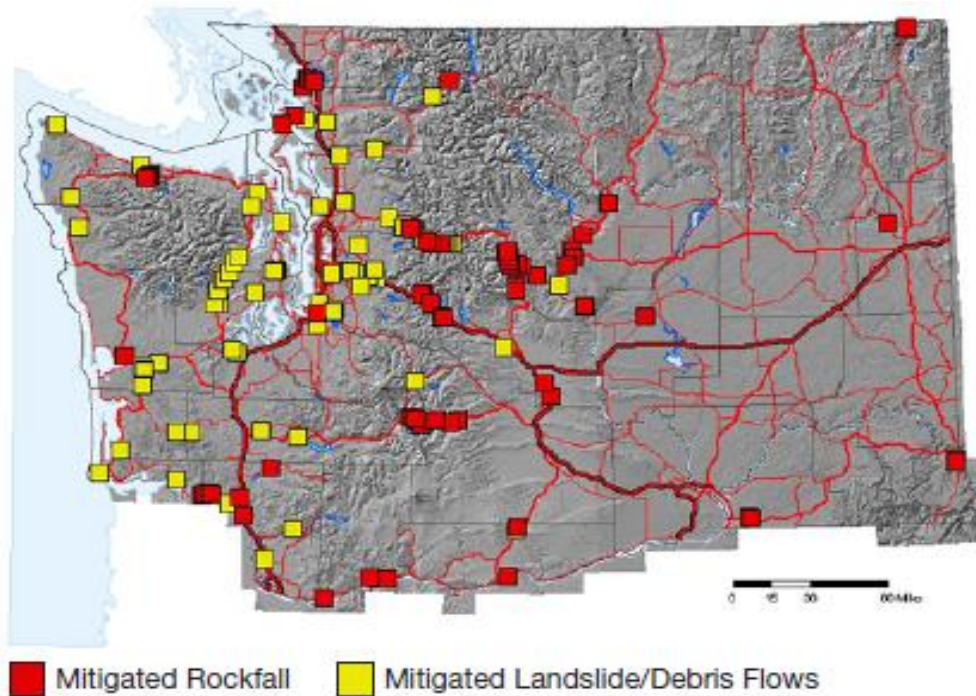

Figure B.2 Mitigated Slopes along State Routes in Washington State (WSDOT, 2010)

APPENDIX C EXAMPLES OF INTERNATIONAL AND AGENCY STANDARD RISK

FRAMEWORK

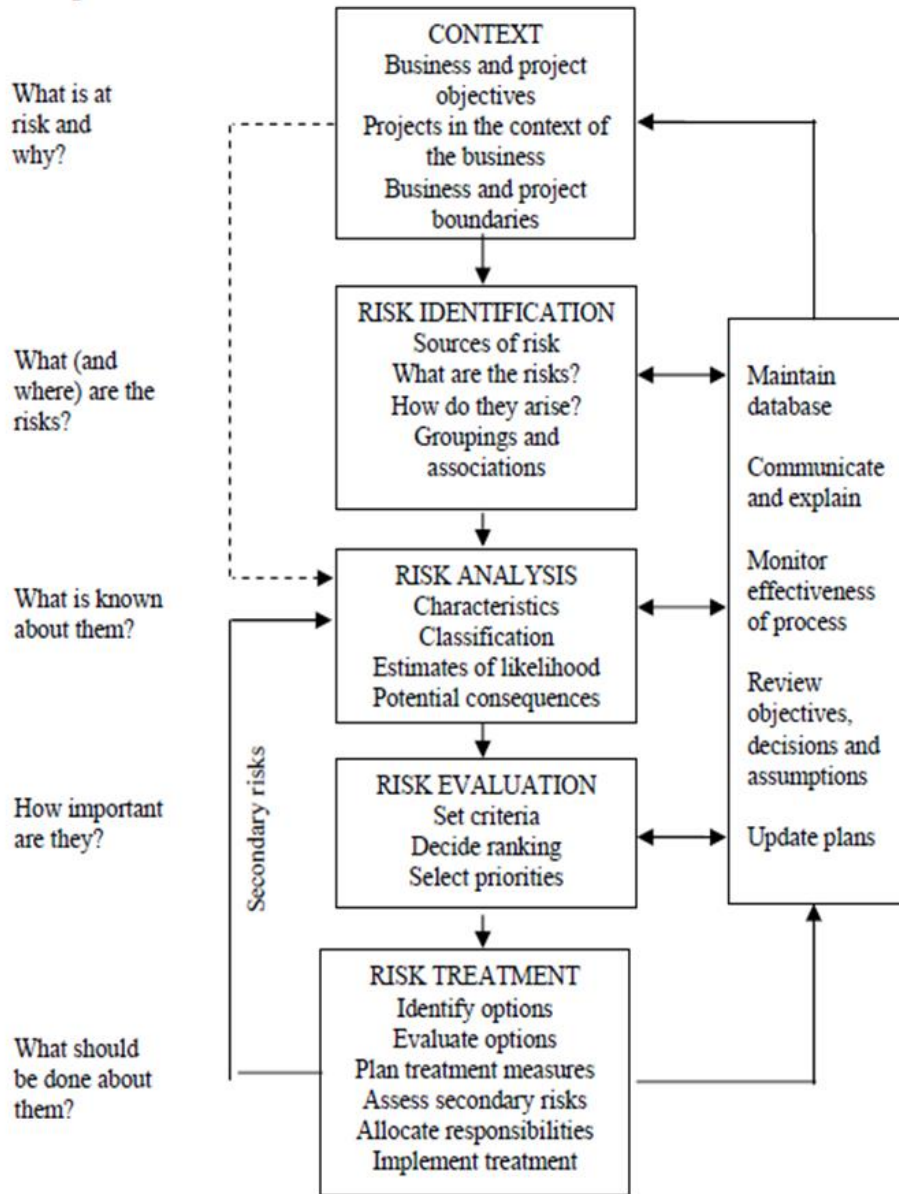

Figure C.1 The British Standards Risk Framework (BSI) (Shortreed, Hicks, & Craig, 2003)

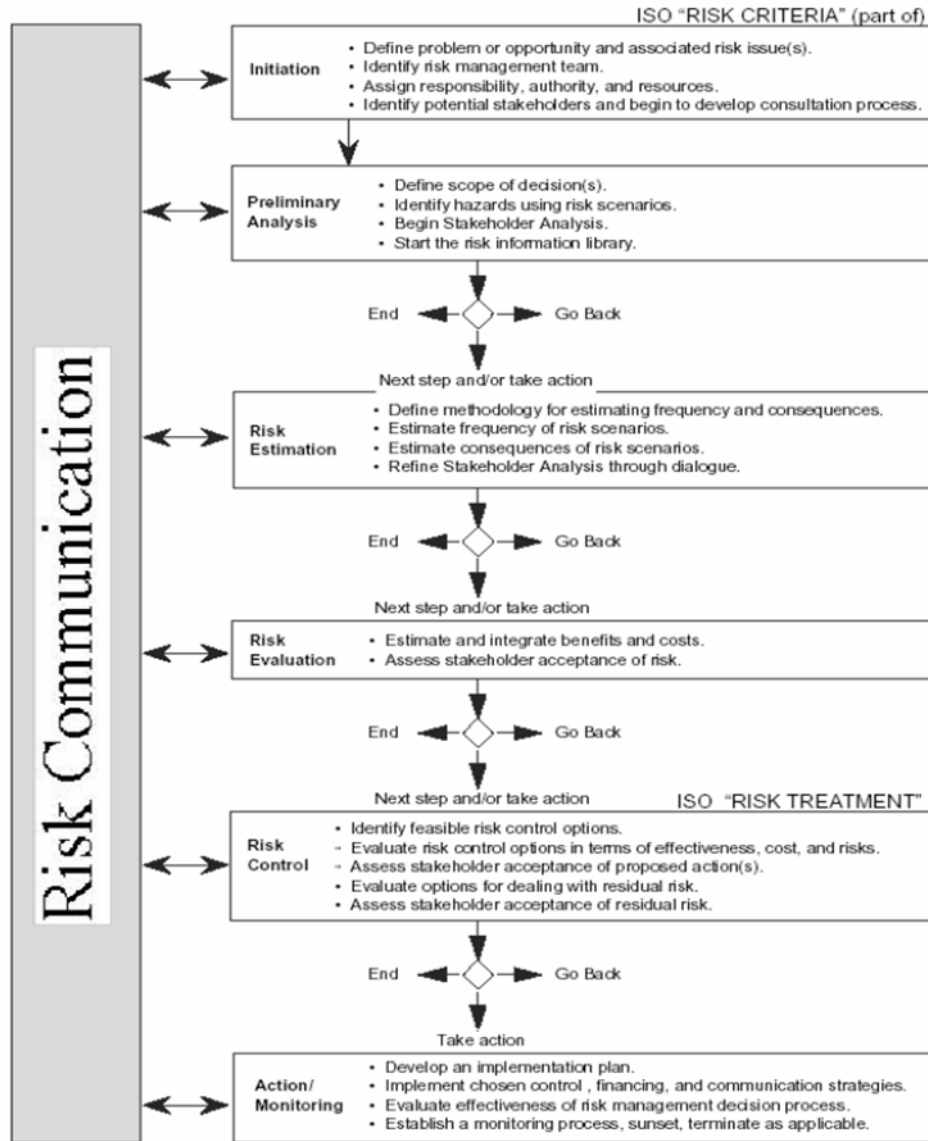

Figure C.2 Canadian Standards Risk Framework (Shortreed, Hicks, & Craig, 2003)

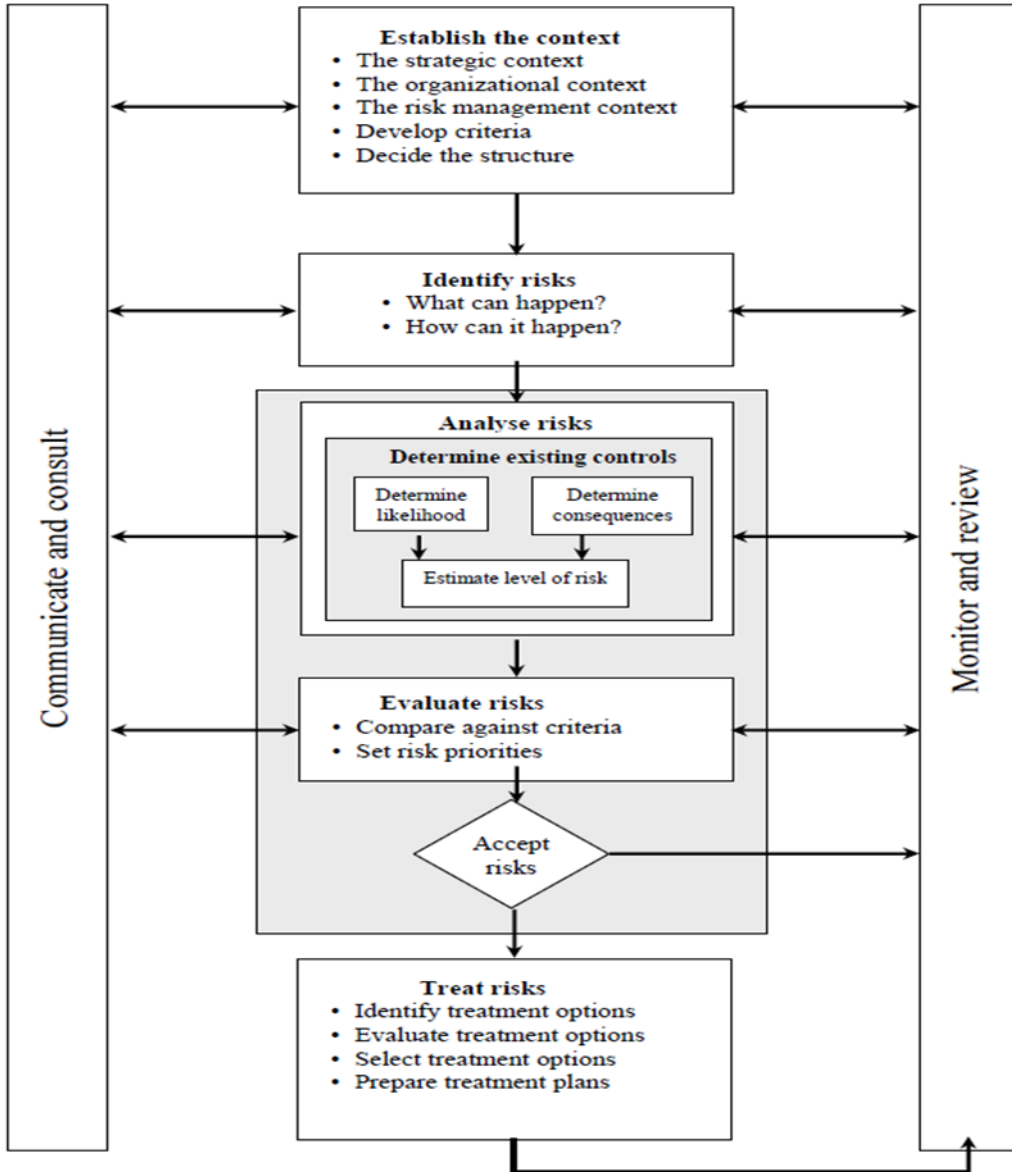
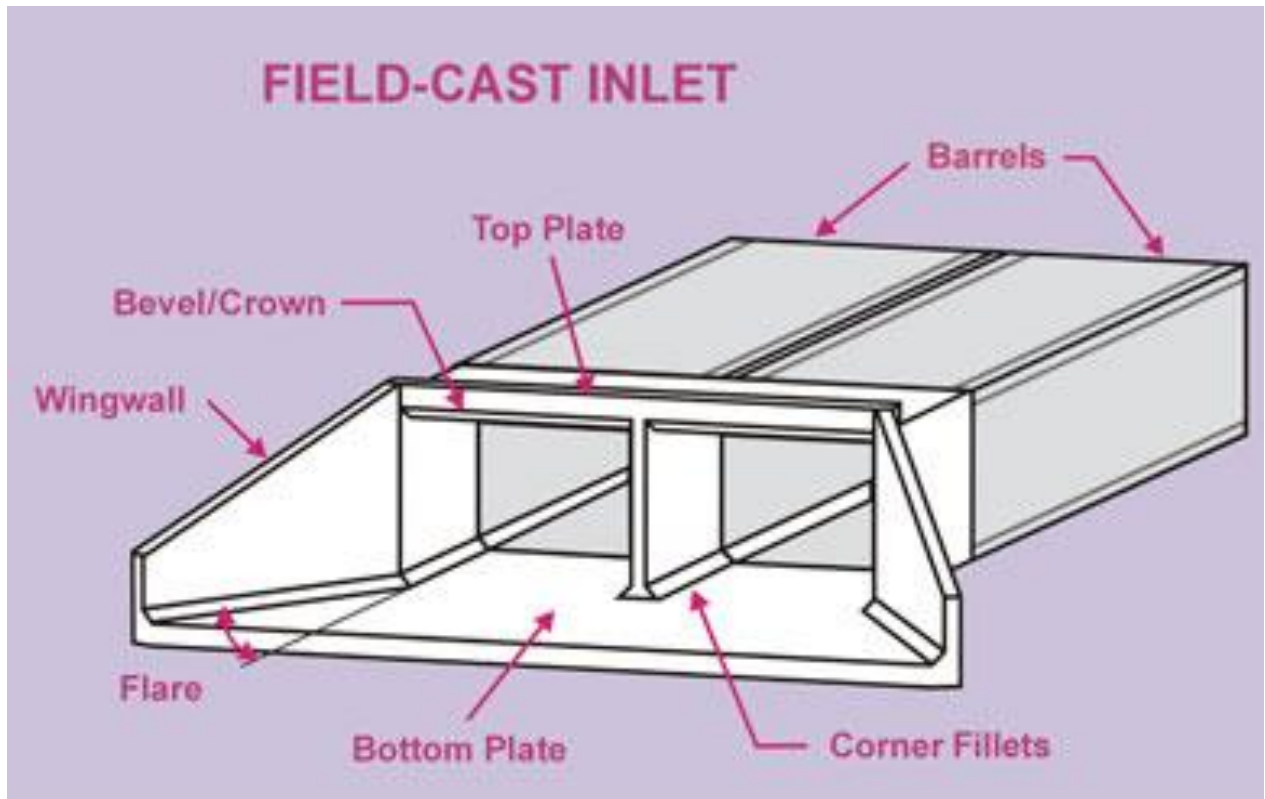

Figure C.3 Australian-New Zealand Standards Risk Framework (AS/NZS, 4360:1999)
(Shortreed, Hicks, & Craig, 2003)



Figure C.4 The Department of Homeland Security (DHS) Risk Framework (USDHS, 2011)

APPENDIX D TYPICAL COMPONENTS OF A CULVERT FOR PERFORMANCE ANALYSIS



Source: www.fhwa.dot.gov

APPENDIX E.1 MnDOT CORRIDOR VULNERABILITY TO PLATEBEAM BARRIER FAILURE

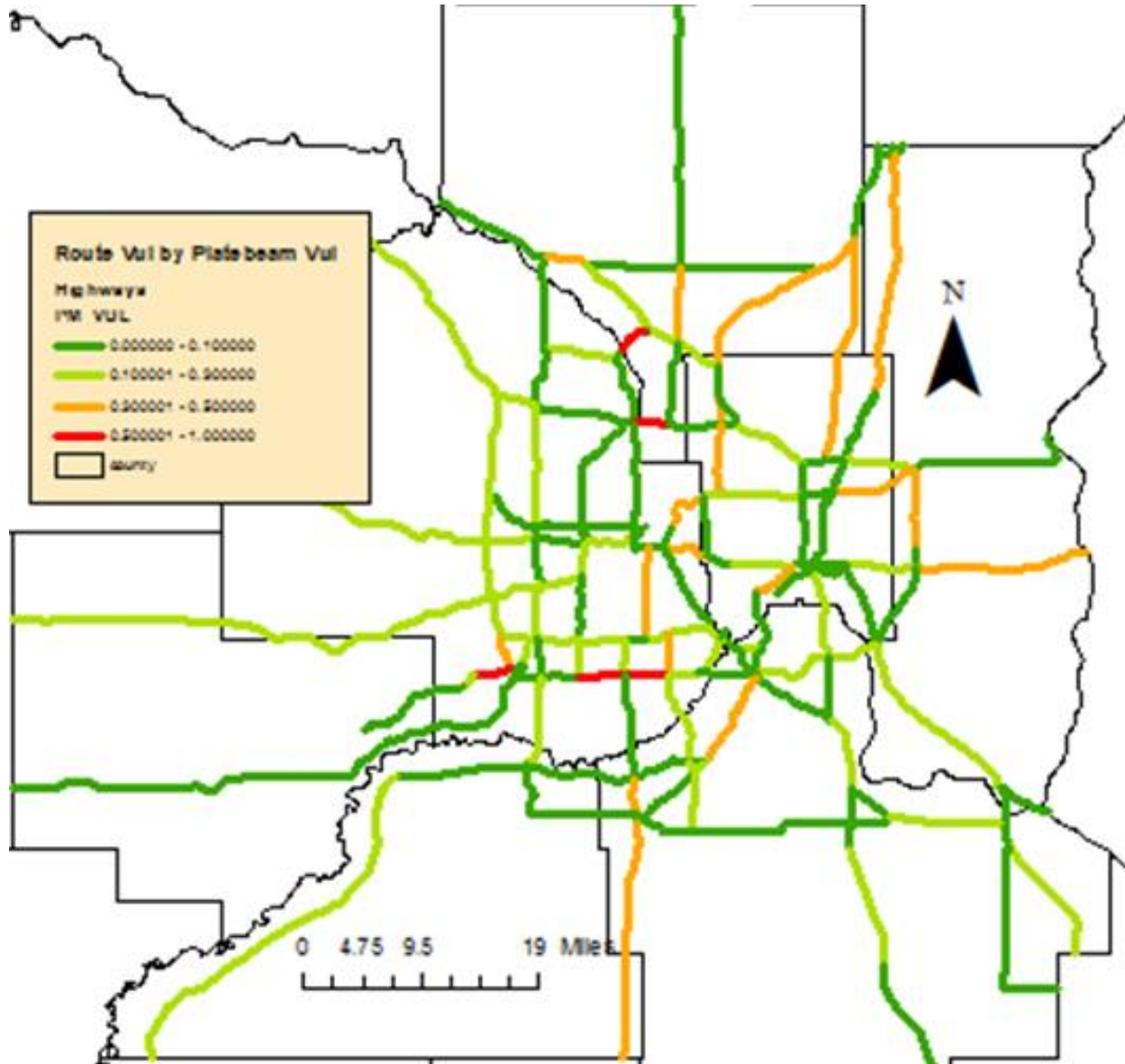

APPENDIX E.2 MnDOT CORRIDOR VULNERABILITY TO OVERHEAD SIGN STRUCTURES FAILURE

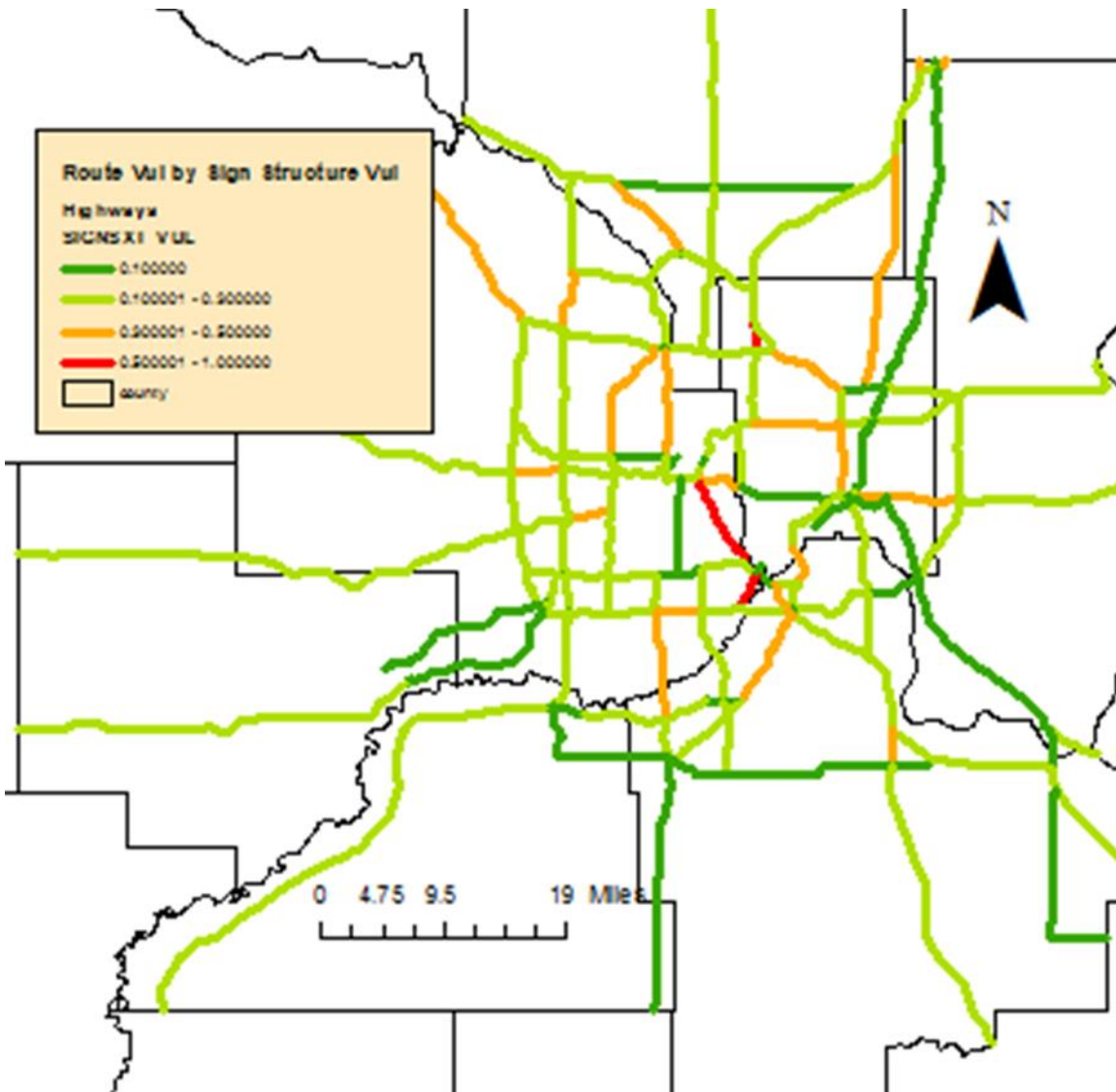

APPENDIX E.3 MnDOT CORRIDOR VULNERABILITY TO CULVERTS FAILURE

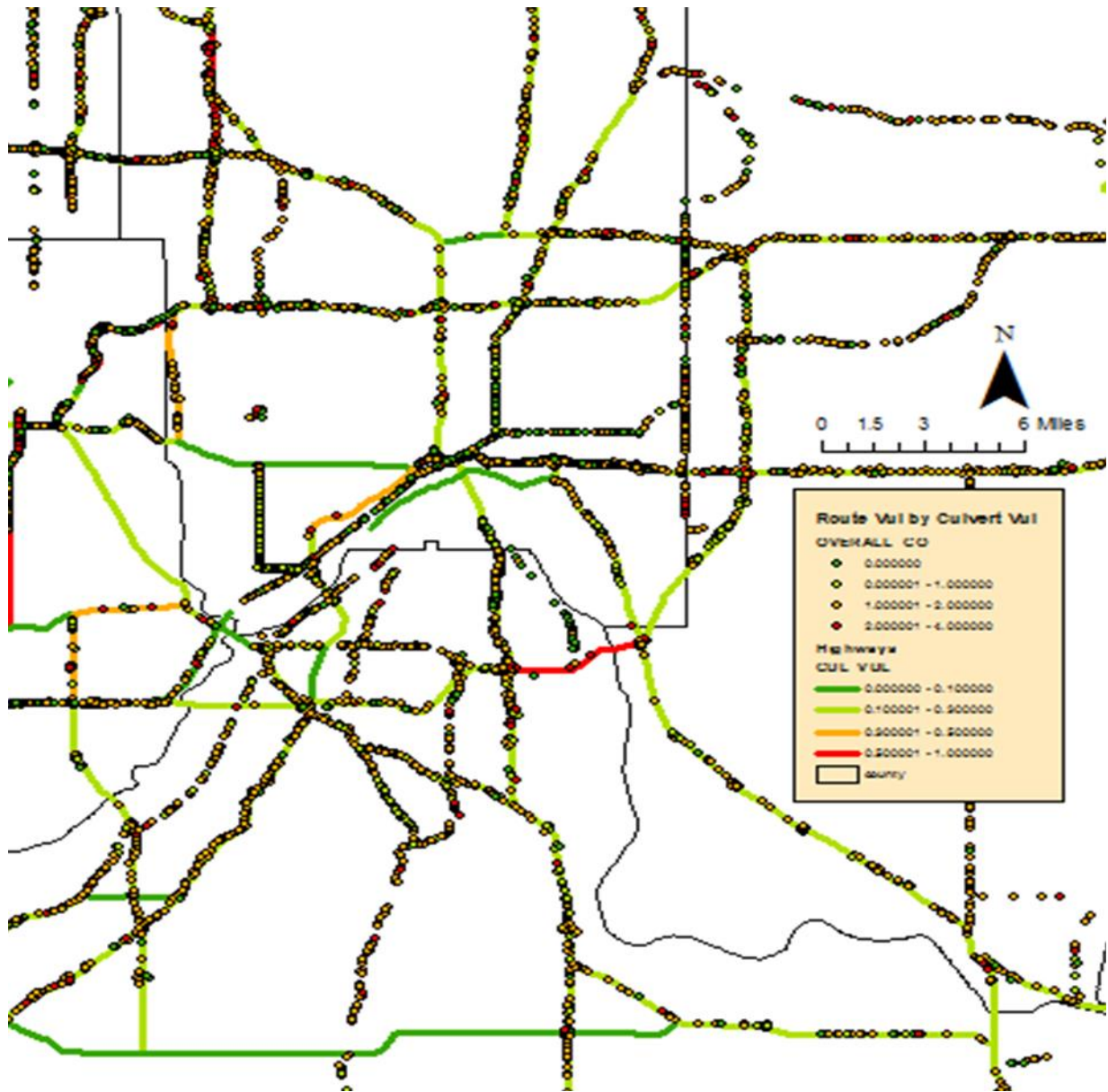

APPENDIX F.1 NYSDOT CULVERT VULNERABILITY AND RELATIVE LOCATIONS

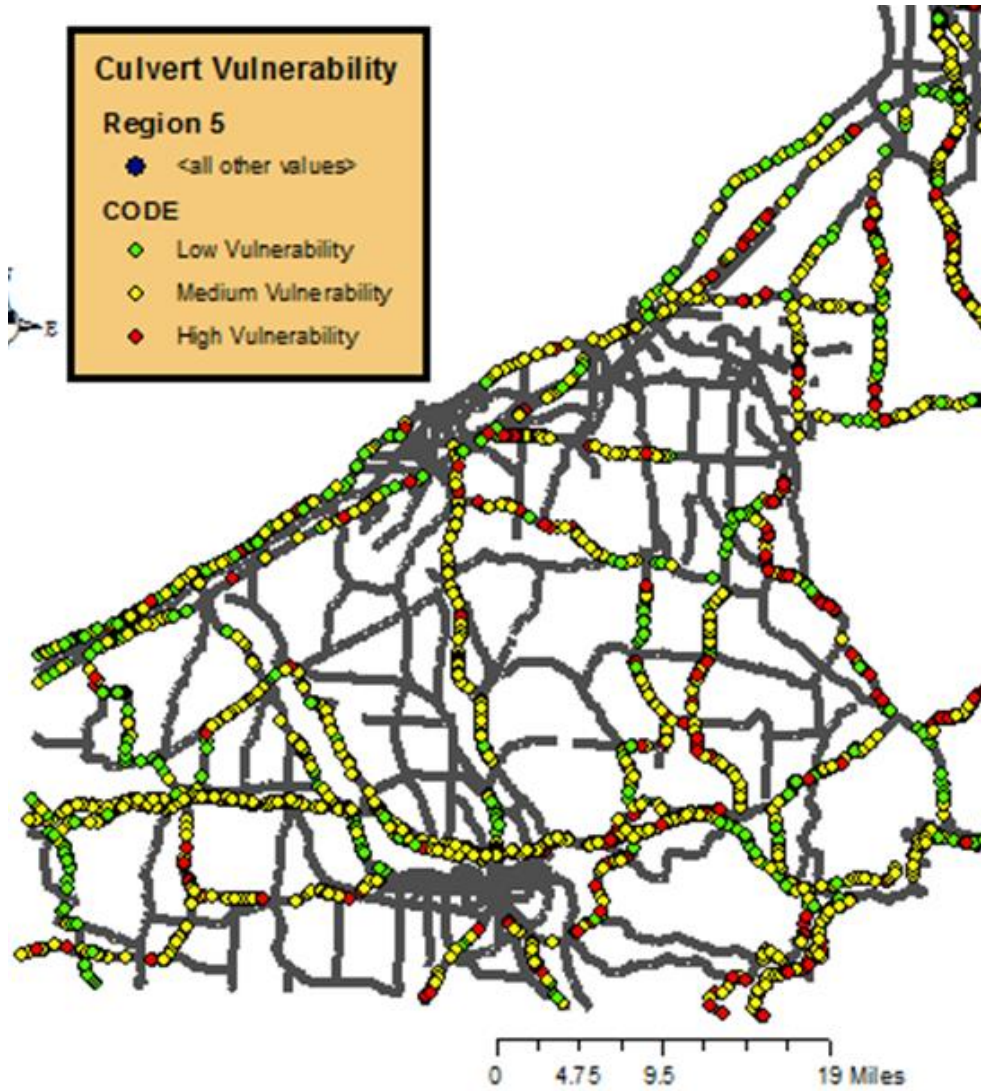

APPENDIX F.2 NYSDOT CORRIDOR VULNERABILITY TO CULVERTS FAILURE

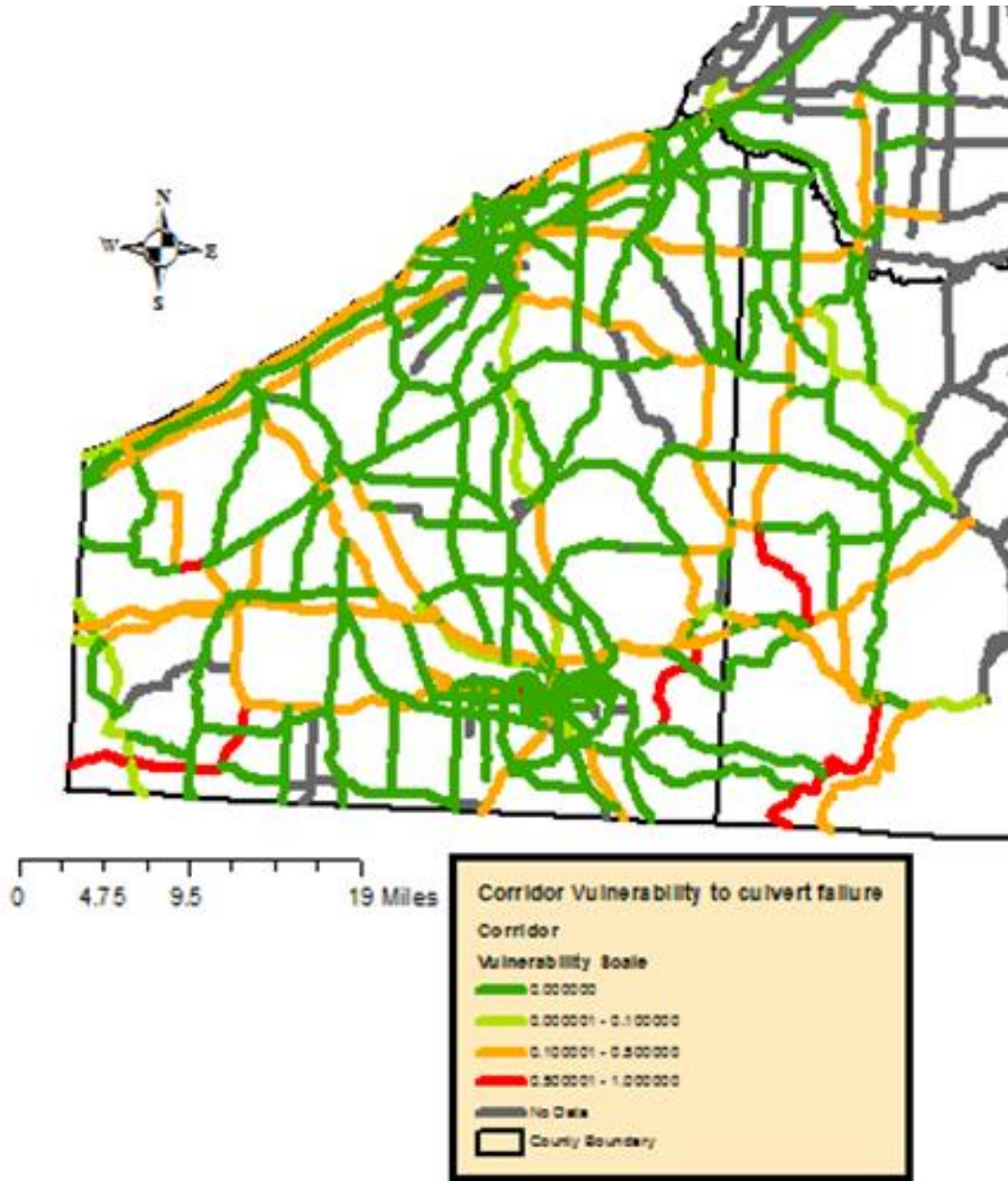

APPENDIX F.3 NYSDOT CORRIDOR VULNERABILITY TO GUARDRAILS FAILURE

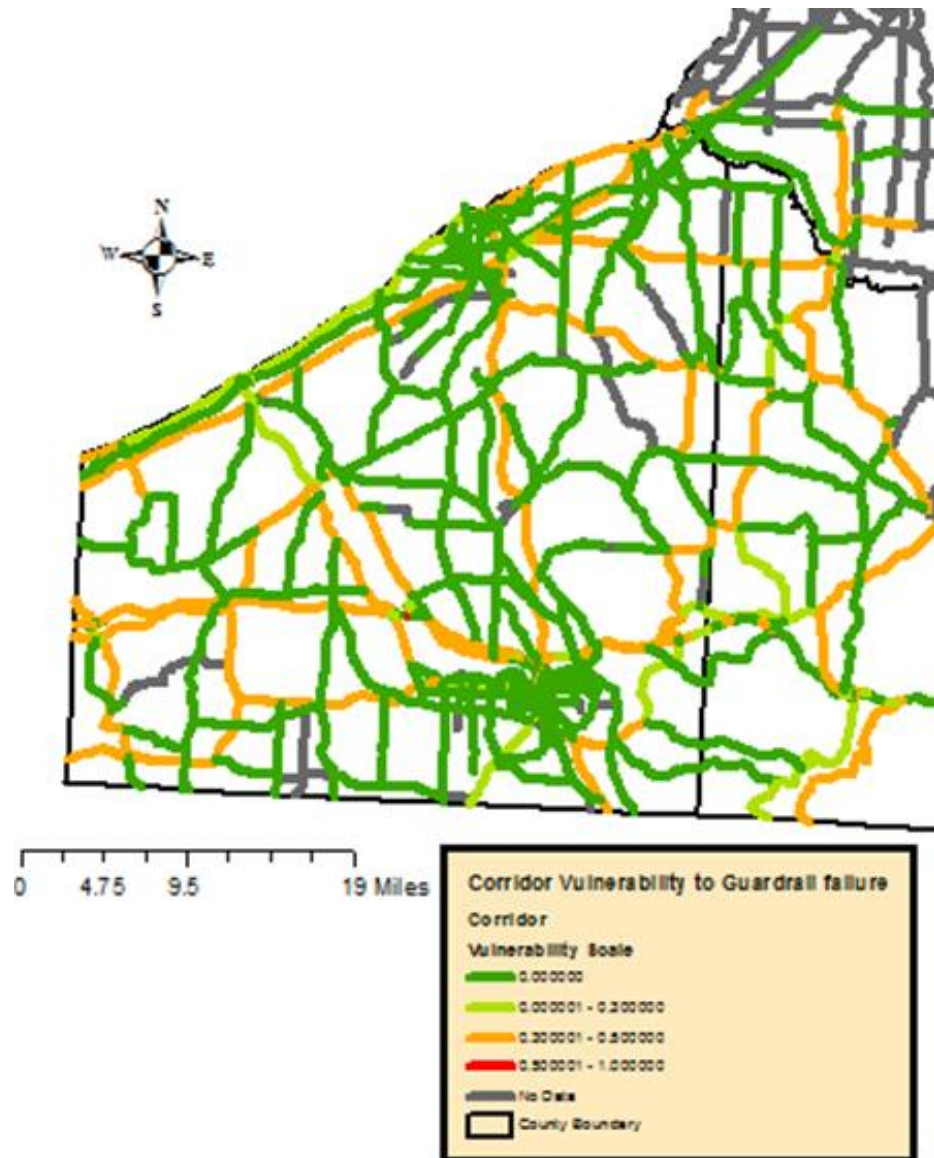

APPENDIX G.1 ODOT CORRIDOR VULNERABILITY TO UNSTABLE SLOPE FAULURE

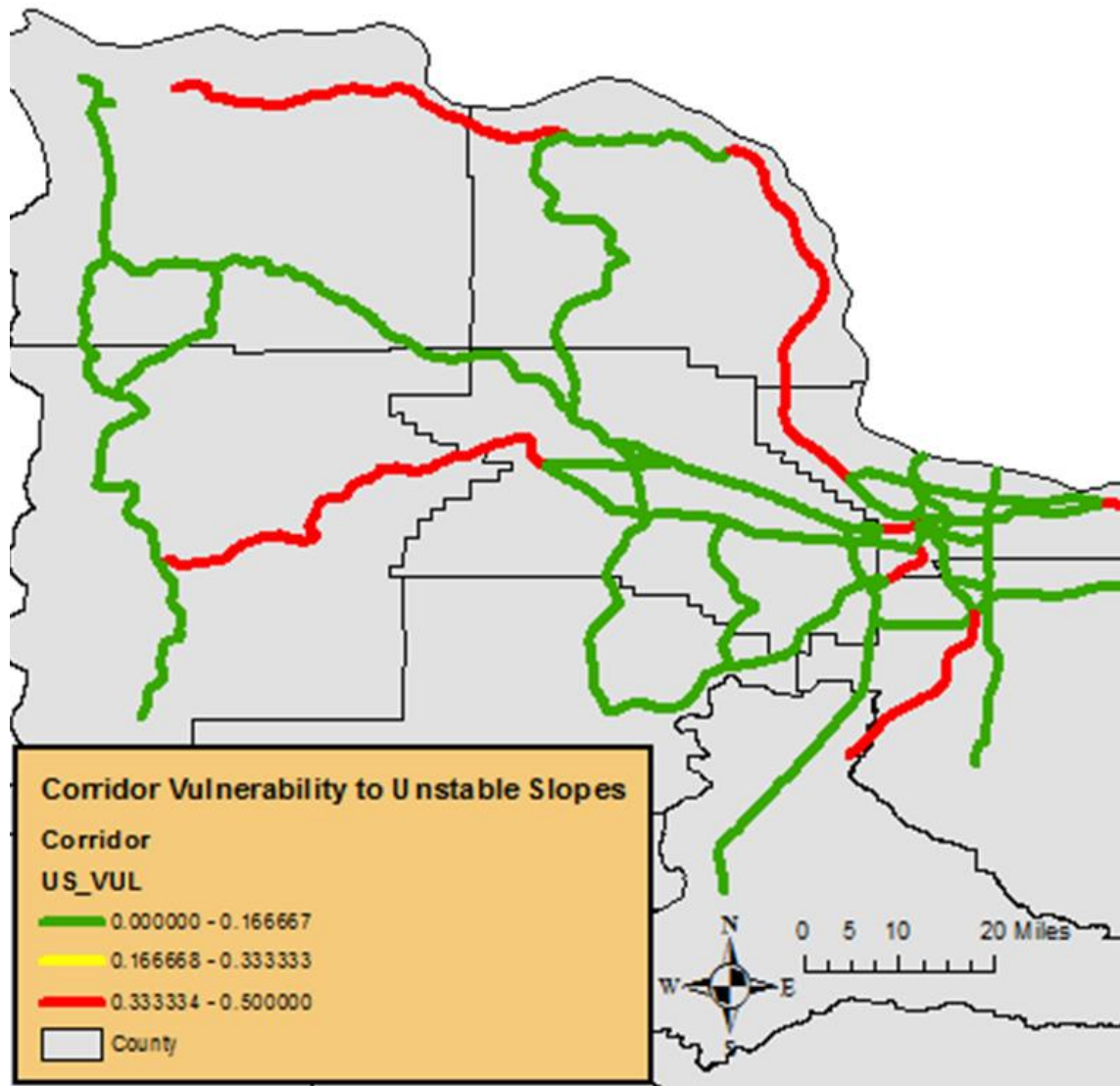

APPENDIX G.2 ODOT CORRIDOR VULNERABILITY TO CULVERTS FAILURE

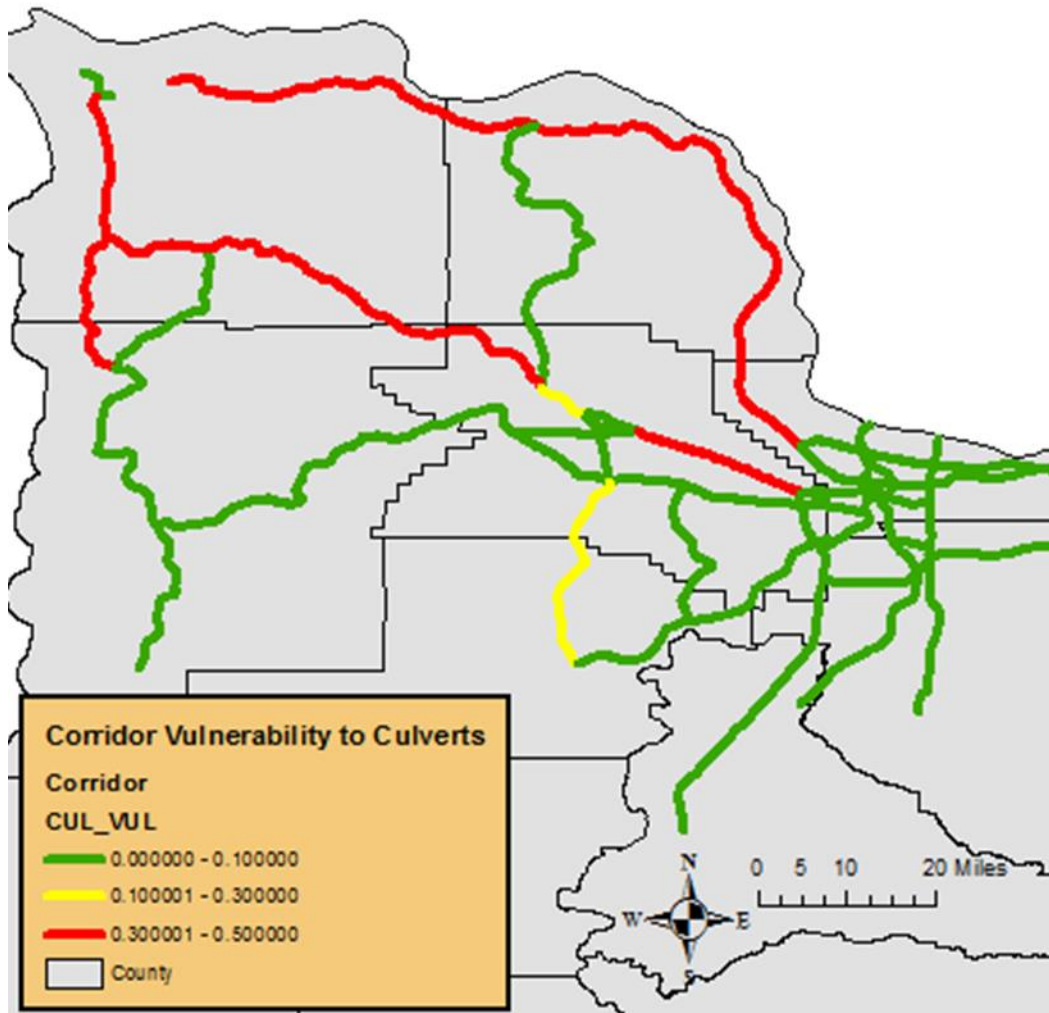

APPENDIX G.3 ODOT CORRIDOR VULNERABILITY TO EARTH RETAINING STRUCTURES FAILURE

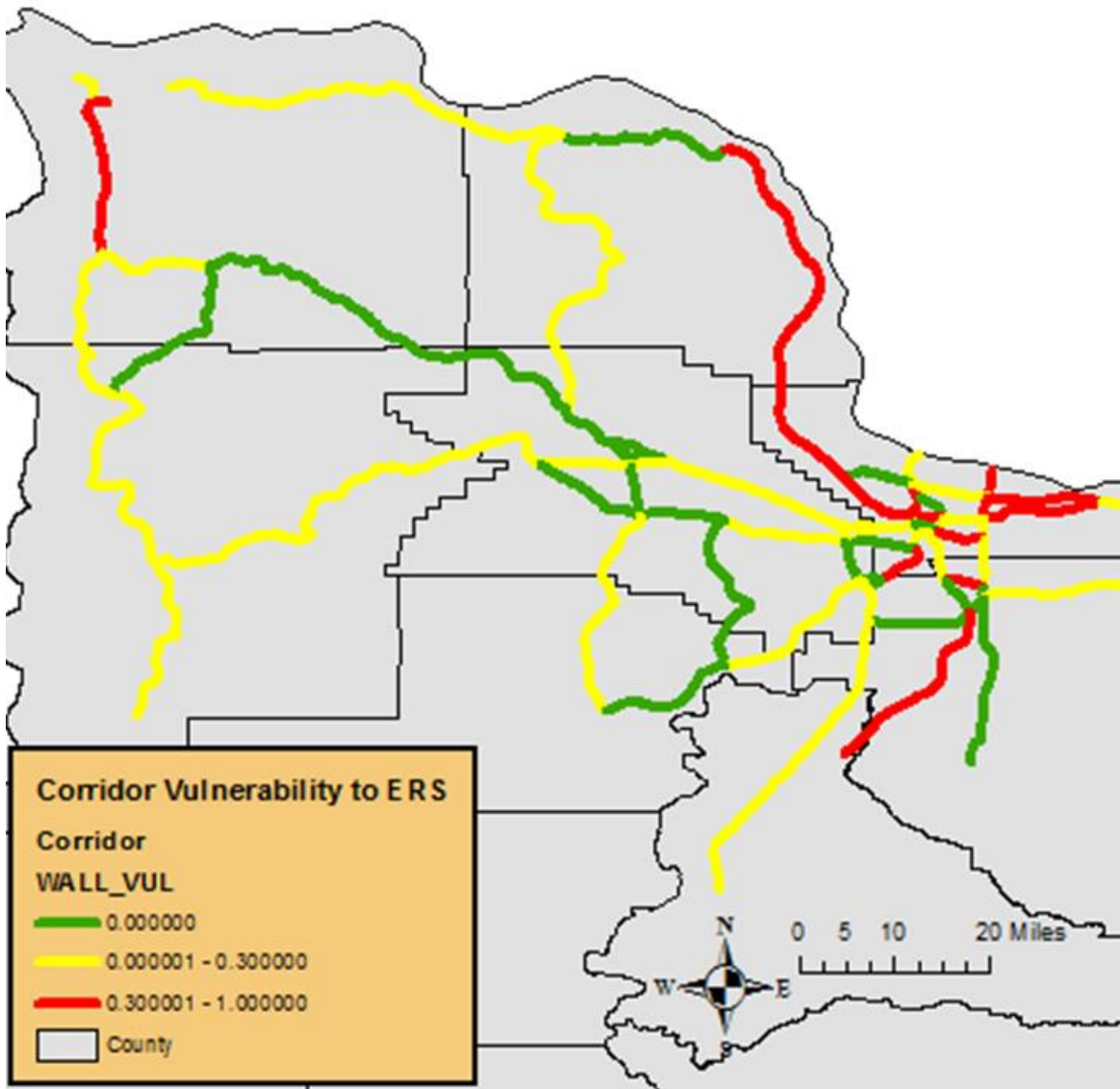

REFERENCES

- Akofio-Sowah, M. A., Boadi, R., Amekudzi, A., & Meyer, M. (2014). Managing Ancillary Transportation Assets: The State of the Practice. *Journal of Infrastructure System*, 20(1), 1-8.
- Amekudzi, A., & McNeil, S. (2000). Capturing Data and Model Uncertainties in Highway Performance Estimation. *Journal of Transportation Engineering*, 455-463.
- Amekudzi, A., Meyer, M., Akofio-Sowah, M., & Boadi, R. (2011). *Comprehensive Transportation Asset Management: Making a Business Case and Prioritizing Assets for Inclusion in Formal Asset Management Programs*.
- American Association of Highway and Transportation Officials. (January 2011). *American Association of State Transportation Asset Management Guide, Volume 2 – A Focus on Implementation*. Washington, D.C.: Transportation Research Board.
- Anderson, R. (2011). *Guidance Paper: Risk Appetite and Tolerance*. London: The Institute of Risk Management.
- Anderson, S. A., & Rivers, B. S. (2013). Corridor Management: A Means to Evaluate Understanding of Geotechnical Impacts on System Performance. *Transportation Research Record: Journal of the Transportation Research Board*, 9-15.
- Australian Transport Council. (2006). *National Guidelines for Transport System Management in Australia--Part 2: Strategic transport planning and development*.
- Ayyub, B. M. (2001). *Elicitation of Expert Opinions for Uncertainty and Risks*. Boca Raton, Fla: CRC Press.

- Ayyub, B. M. (2003). *Risk Analysis in Engineering and Economics*. Boca Raton, Florida: Chapman & Hall/CRC.
- Boadi, R. S., & Amekudzi, A. (2014). Risk-Based Management of Ancillary Transportation Assets: Applying the Delphi Method to Estimate the Risk of Failure . *93rd Annual Meeting of the Transportation Research Board*. Washington, D.C.
- Boadi, R., & Amekudzi, A. (2013). Risk-Based Corridor Asset Management: Applying Multi-Attribute Utility Theory to Manage Multiple Assets. *Transportation Research Record: Journal of the Transportation Research Board*, 99-106.
- Brutus, O., & Tauber, G. (2009). *Guide to Asset Management of Earth Retaining Structures, NCHRP Report 20-07*.
- Cambridge Systems, Inc.; Parsons Brinckerhoff; Quade & Douglas, Inc.; Ray Jorgenson Associates Inc.; Thompson, P. D. . (2002). *Tranportation Asset Management Guide*. Washington D.C. NCHRP Report 20-24.
- Cavalli-Sforza, V., & Ortolano, L. (1984). Delphi Forecasts of Land Use: Transportation Interactions. *Journal of Transportation Engineering*, 324-339.
- Chairman of the Joint Chiefs of Staff Manual. (2004). *Operations of the Joint Capabilities Integration and Development System*.
- Committee to Review the Department of Homeland Security's Approach to Risk Analysis; National Research Council. (2010). *Review of the Department of Homeland Security's Approach to Risk Analysis* . National Research Council.

- Cox, L. A. (2007). What's Wrong with Hazard-Ranking Systems? An Expository Note. *Risk Analysis*, 29(7), 940-948.
- Dalkey, N. C., & Helmer, O. (1963). An experimental application of the Delphi method to the use of experts . *Management Science*, 9(3), 458-467.
- Environmental Protection Agency, United States Department of Transportation, and Federal Highway Administration. (2009). *Multi-sector Asset Management Case Studies* . Washington. D.C.
- Federal Highway Administration. (2005). *Transportation Asset Management in Australia, Canada, England, and New Zealand. Prepared for NCHRP Panel 20-36.* . Washington, D.C.: Transportation Research Board.
- Federal Highway Administration. (August 2012). *Transportation Risk Management: International Practices for Program Development and Project Delivery.*
- FHWA. (2012). *Risk-based Asset Management: Examining Risk-based Approaches to Transportation Asset Management.* Washington, D.C.
- FHWA. (2012). *Risk-Based Transportation Asset Management: Achieving Policy Objectives by Managing Risks.* Washington, D.C.
- FHWA. (2012). *Risk-based Transportation Asset Management: Building Resilience into Transportation Assets.* Washington, D.C.
- FHWA. (2012). *Risk-Based Transportation Asset Management: Evaluating Threats, Capitalizing on Opportunities.* Washington, D.C.

FHWA. (2012). *Risk-based Transportation Asset Management: Managing Risks to Networks, Corridors, and Critical Structures*. Washington, D.C.

FHWA. (n.d.). <http://www.fhwa.dot.gov/asset/plans.cfm>. Retrieved July 5, 2014, from <http://www.fhwa.dot.gov/asset/plans.cfm>

Fischhoff, B., Lichtensein, S., Slovic, P., Keeney, R., & Derby, S. (1980). *Approaches to Acceptable Risk: A Critical Guide*. Eugene, OR: Oak Ridge National Laboratory Sub-7656.

Garlich, M., & Thorkildsen, E. (2005). *Guidelines for the Installation, Inspection, Maintenance, and Repair of Structural Supports for Highway Signs, Luminaires, Traffic Signals*, FHWA NHI 05-036.

Garvey, P. R. (2009). *Analytical Methods for Risk Management: A Systems Engineering Perspective*. Boca Raton, FL: Chapman & Hall/CRC.

Goodchild, M. F. (1987). A Spatial Analytical Perspective on Geographic Information System. *International Journal of Geographical Information Systems*, 1(4), 327-334.

Grimshaw, D. (1994). *Bringing Geographical Information Systems into Business*. Harlow, Essex: Longman Scientific and Technical.

Haines, Y. Y. (2006). On the Definition of Vulnerabilities in Measuring Risks to Infrastructure. *Risk Analysis*, 293-296.

Haines, Y. Y. (2009). *Risk Modeling, Assessment, and Management*. New Jersey: John Wiley Publishers.

- Haimes, Y. Y., & Jiang, P. (2001). Leontief-Based Model of Risk in Complex Interconnected Infrastructures. *Journal of Infrastructure Systems*, 1-12.
- Harrison, F. (2005). *NCHRP Report 545: Analytical Tools for Asset Management*. Washington, D.C.
- Hatfield, A., & Hipel, K. (2002). Risk and Systems Theory. *Risk Analysis*, 22(6), 1043-1057.
- Hawkins, N., & Smadi, O. (2013). *Use of Asset Management Principles in State Highway Agencies*. Washington, D.C.: Transportation Research Board.
- Helton, J. C., & Burnmaster, D. E. (1996). Treatment of Aleatory and Epistemic Uncertainty in the Performance of Complex Systems. *Reliability Engineering and System Safety*, 54, 91-94.
- Hsu, C.-C., & Sandford, B. A. (2007, August). The Delphi Technique: Making Sense of Consensus. *Practical Assessment, Research and Evaluation*, XII, ISSN 1531-7714.
- Hubbard, D. (2010). *How to Measure Anything: Finding the Value of Intangibles in Business*. Hoboken, New Jersey: John Wiley & Sons, Inc.
- Hubbard, D. W. (2009). *The Failure of Risk Management: Why It's Broken and How to Fix It*. Hoboken, New Jersey: John Wiley & Sons, Inc.
- International Infrastructure Management Manual (IIMM), I. E. (2011).
- Jones, C. G. (1975). *A Delphi Evaluation of Agreement between Organizations*. Reading, MA: Addison-Wesley Publishing Company.

- Jordan, E., & Javernick-Will, A. (2013). Indicators of Community Recovery: Content Analysis and Delphi Approach. *Natural Hazards Review*, 21-28.
- Kaplan, S., & Garrick, B. (1981). On the Quantitative Definition of Risk. *Society for Risk Analysis*, 1(1), 11-27.
- Keeney, R. L. (1982). Decision Analysis: An Overview. *Operations Research*, 803-838.
- Keeney, R. L., & Gregory, R. S. (2005). Selecting Attributes to Measure the Achievement of Objectives. *Operations Research*, 53(1), 1-11.
- Keeney, R., & Raiffa, H. (1976). *Decisions with Multiple Objectives: Preferences and Value Tradeoffs*. New York: Wiley.
- Keeney, R., & Raiffa, H. (1993). *Decisions with Multiple Objectives: Preferences and Value Tradeoffs*. Cambridge, UK: Cambridge University Press.
- Kim, Y. R., HUMMER, J. E., Gabr, M., Johnson, D., Underwood, B. S., Findley, D., & Cunningham, C. M. (2009). *Asset Management and Inventory and Data Collection, FHWA/NC/2008-15*.
- Kirkwood, C. (1997). *Strategic Decision Making: Multiobjective Decision Analysis with Spreadsheets*. Pacific Grove, CA: Duxbury Press.
- Kirkwood, C. W. (1991). *Notes on Attitude Toward Risk Taking and the Exponential Utility Function*. Tempe, Arizona: Department of Management, Arizona State University.
- Krile, R. (2012). *Integrated Corridor Management Initiative: Demonstration Phase Evaluation-San Diego Traveler Response Analysis Test Plan*.

- Li, Z., & Madanu, S. (2008). *A Methodolgy for Integrating Roadway Safety Hardware Management into the Overall Highway Asset Management Program*.
- Lofsted, R., & Boholm, A. (2009). *The earth scan reader on risk*.
- Major, D., & O'Grady, M. (2010). "Appendix B: Adaptation Assessment Guidebook." *New York City Panel on Climate Change 2010 Report*. New York: New York City Panel on Climate Change.
- Matheus, C., Chan, P., & Piatetsky-Shapiro, G. (1993). Systems for Knowledge Discovery in Databases. *IEEE Transactions on Knowledge and Data Engineering*, 5(6).
- Meyer, M., Amekudzi, A. A., & O'Har, J. (2010). Transportation Asset Management Systems and Climate Change: An Adaptive System Management Approach. *89th Annual Meeting of the Transportation Research Board*. Washington, D.C.: National Academies.
- Meyer, M., Flood, M., Keller, J., Lennon, J., McVoy, G., Dorney, C., . . . Smith, J. (2014). *Strategic Issues Facing Transportation Volume II: Climate Change, Extreme Weather Events, and the Highway System*. Washington, D.C.: Transporation Research Board.
- Meyer, Micheal and Parsons-Brinkerhoff. (2009). "NCHRP 20-83(05) Climate Change and the Highway System: Impacts and Adaptions Approaches.". Washington, D.C.: Transportation Research Board of Academies, ed., The National Academies.
- Office of Asset Management; FHWA; U.S. Department of Transportation. (1999). *Asset management primer*. Washington, D.C.
- Pate-Cornell, M. E. (1996). Uncertainties in Risk Analysis: Six Levels of Treatment. *Reliability Engineering and System Safety*, 95-111.

- Perrin, J. J. (April 2006). The Economic Analysis of the Impacts of Culverts Failures. *Les conférenciers du congrès AQTR*.
- Perrone, E., Clark, D., Ness, Q., Chen, X., & Hudson, S. (1998). Risk-based Life Cycle Cost Analysis for Project Level Pavement Management. *4th International Conference on Managing Pavements*.
- Pill, J. (1971). The Delphi Method: Substance, Context, a Critique and an Annotated Bibliograph. *Socio-Economic Planning Science*, 57-71.
- Robbinson, J. B. (1990). Delphi Methodology for Economic Impact Assessment . *Journal of Transportation Engineering*, 335-349.
- Rose, D., Shah, K., & O'Har, J. P. (2014). *Transportation Asset Management for Ancillary Assets*. Washington, D.C.: Transportation Research Board.
- Saaty, T. L. (1999). *Decision Making for Leaders: the Analytical Hierarchy Process for Decision in a Complex World*. Pittsburgh: RWS Publications.
- Saito, M., & Sinha, K. (1991). Delphi Study on Bridge Condition Rating and Effects of Improvements. *Journal of Transportation Engineering*, 320-334.
- Shepard, R. (1964). *On Subjective Optimal Selections among Multi-attribute Alternatives: Human Judgments and Optimality*. New York: M. Shelley and G. Bryan.
- Shortreed, J., Hicks, J., & Craig, L. (2003). *Basic Frameworks for Risk Management*. The Ontario Ministry of the Environment.

Stefanski, T. (2014). *Minnesota Department of Metro Barrier Extraction and LiDAR Project*.
Minnesota Department of Transportation.

The International Organization for Standardization (ISO) . (2009). *Guide 73*.

United States Department of Homeland Security. (2011). *Risk Management Fundamentals: Homeland Security Risk Management Doctrine*.

VanDyke, C. L., Cox, D., Hecke, S. V., Guerre, J., & Beagan, D. (2014). Combining Risk Management and Asset Management on Georgia's Interstate Highway System. *93rd Annual Meeting of the Transportation Research Board*. Washington, DC.

Voogd, H. (1983). *Multicriteria Evaluation for Urban and Regional Planning*. London: Pion, Ltd.

Washington State Department of Transportation. (2010). *WSDOT's Unstable Slope Management Program*. Washington State DOT.

Yang, H., & Yagar, S. (1994). Traffic Assignment and Traffic Control in General Freeway-arterial Corridor Systems. *Transportation Research Part B.*, 28B(6), 463-486.