

# STORYSCAPE, A NEW MEDIUM OF MEDIA

A Dissertation  
Presented to  
The Academic Faculty of the  
Georgia Institute of Technology

by

Henry (Hank) Blumenthal

In Partial Fulfillment  
Of the Requirements for the Degree  
Doctor of Philosophy in the  
Digital Media Program  
School of Literature, Media, and Communication

Georgia Institute of Technology  
May 2016

**COPYRIGHT© 2016 BY HENRY (HANK) BLUMENTHAL**

## STORYSCAPE, A NEW MEDIUM OF MEDIA

Approved by:

Dr. Jay David Bolter, Advisor  
School of Literature, Media, and  
Communication  
*Georgia Institute of Technology*

Dr. Janet Murray  
School of Literature, Media, and  
Communication  
*Georgia Institute of Technology*

Dr. Marie-Laure Ryan

Dr. Carl DiSalvo  
School of Literature, Media, and  
Communication  
*Georgia Institute of Technology*

Dr. Michael Nitsche  
School of Literature, Media, and  
Communication  
*Georgia Institute of Technology*

Date Approved: March 2016

To my mother, Eleanor Cooper Blumenthal Lewis, a beautiful mind who always encouraged me to seek knowledge, truth, and art.

## ACKNOWLEDGEMENTS

My list of acknowledgements is extensive because many kind and brilliant people have made this dissertation possible. My gratitude knows no bounds. This list only hints at the sincere appreciation I feel toward my colleagues, creative partners, faculty, administration, and committee at the Georgia Institute of Technology and around the world.

My academic colleagues have been challenging and supportive, and guided me through the research process and plan. This list includes Dr. Mads Haahr of Trinity College and Dr. Yan Xu at Intel Research Labs, who collaborated on multiple iterations of augmented reality games. Dr. Thomas Lodato was an integral collaborator in the creation of the *Ghost Club* storyscape and its execution in iconography and design. Dr. Christy Dena and Lance Weiler of Columbia University have encouraged, consulted me, and blazed the first paths through the jungle of transmedia storytelling so that I could follow. Dr. Karen Head and Dr. Lisa Yaszek have been constant and stalwart supporters. My fellow Ph.D. students, candidates, and doctors have given invaluable feedback and support, including Tom Jenkins, Paul Clifton, Dr. Bobby Schweizer, and Dr. Andy Quitmeyer.

Michael Mailer, Jason Nunes, Greg Gannet, and Sam Rickles have been working for years on the creative and practical implementations of the *The Ghost Club* storyscape. Jason was a co-creator of many of the story and transmedia elements. In the realm of practice, Nick DeMartino, Jeff Gomez, Caitlin Burns, and Mike Monello contributed profound insights into the actual process and considerations of transmedia storytelling.



My advisors have given robust and consistent support. Dr. Michael Nitsche has contributed in writing, structure, and clarity of purpose. Dr. Carl DiSalvo made me always remember that I was investigating a design process in practice. Dr. Marie-Laure Ryan supplied me with a wonderful foundation of works and also her kind discussions and feedback.

The two guiding mentors to this work have been Dr. Jay Bolter and Dr. Janet Murray. Dr. Murray inspired me to come to the Digital Media program at Georgia Institute of Technology and push the boundaries of theory and practice in digital media storytelling. She demanded that I aim for excellence and originality. Dr. Jay Bolter, my dissertation advisor, challenged every idea, assumption, and argument I made with a depth of knowledge extending back through five thousand years of storytelling and two hundred years of philosophy and media theory. His constant pressure to move forward, long discursive meetings, and unwavering calm support helped immeasurably my surmounting the challenge of expressing myself in the clumsy symbols called words. His greatest contribution was to shape and sharpen the focus of this theory and method by confronting me with his often dissimilar views.

My family, including my sisters Amy Blumenthal and Nancy McManus, and my uncle Fred Blumenthal helped support and cheer me on. My close friends Dr. Richard Straub and Michael Mailer equally had my back through years of intellectual and creative toil and never doubted me. My mother most of all, Eleanor Lewis, gave her unwavering support and belief in my ability to finish my dissertation, imagine original ideas, and, hopefully, contribute intellectually and creatively to our culture.

# TABLE OF CONTENTS

	Page
ACKNOWLEDGEMENTS	iv
LIST OF TABLES	x
LIST OF FIGURES	xi
SUMMARY	xiii
 <u>CHAPTER</u>	
1 INTRODUCTION	1
1.1 An Introduction to Transmedia Storytelling	1
1.2 Key Distinctions in Theory and Practice	4
1.3 Design Study: The <i>Ghost Club Storyscape</i>	7
1.4 The Storyscape Research Questions	10
1.5 Steps to a Theory and Practice of the Storyscape	13
1.6 The Storyscape Medium	17
2 THEORY: TRANSMEDIA THEORISTS AND OTHER THEORETICAL ELEMENTS OF THE STORYSCAPE	21
2.1 Structure of this Literature Review	21
2.2 The Storyscape, a Definition, and the Relationship to Transmedia Storytelling	22
2.3 The Definitions of Transmedia Storytelling and the Storyscape	23
2.3.1 Henry Jenkins and <i>The Matrix</i> model	34
2.3.2 Transmedia First Principles and Main Topics	35
2.4 Topics in Transmedia Storytelling	40
2.4.1 World-Building, World-Making, and Storyworlds	42
2.4.2 Closure	51

2.4.3 Collaborative Authorship	56
2.4.4 Spreadability and Drillability	59
2.4.5 Synergy, Synergistic Storytelling, and Intellectual Property Exploitation	61
2.4.6 Landmarks, Sync, Triangulation, and Redundancy in the Storyscape	61
2.4.7 Topics Summary	67
2.5 Affordances of the Storyscape Model of Transmedia Storytelling	68
2.5.1 Collective Intelligence, Crowdsourcing, User Participation in Groups	68
2.5.2 Additive Comprehension	71
2.5.3 Participatory, Paratexts, and Role-playing affordances	73
2.5.4 Negative Capability, Extensions, and Migratory Cues	78
2.5.5 Subjectivity and Extensions	82
2.3.6 Verisimilitude, Blurred Reality, and the Epistolary Form	83
2.3.7 Four Affordances—Procedural, Encyclopedic, Spatial, Participatory	87
2.6 The Big Picture	89
2.6.1 Criticism of this Model of Transmedia Storytelling	95
2.6.2 Transmedia and Coherence: Bordwell and Thompson	97
3 STORYSCAPE DESIGN AND THE FOUR GESTALTS	102
3.1 A Definition of Myth for a Storyscape	110
3.1.1 How Myth Defines the Structure of Stories	110
3.1.2 The History of the Study of Myth	111
3.1.3 Levi-Strauss and Barthes—Toward a Model of a Myth as a Structure for Stories	117
3.2 Mythology and Mythopoeia	120

3.2.1	Mythology, the Story Bible, and Storyscape Practice	126
3.2.2	The Study of Mythology Applied to the Mythopoeia of the Storyscape	141
3.2.3	Mythopoeia in the Storyscape	146
3.3	A Summary of Myth and Mythology in a Storyscape	148
3.4	Character, Canon, and Genre	149
3.4.1	Character	149
3.4.2	Canon	154
3.4.3	Canon, Non-Canon, Fanon, and Multiplicity	159
3.4.4	Genre	167
3.5	The Four Gestalts—Summary	169
4	LOST AS AN EXEMPLAR OF TRANSMEDIA STORYTELLING AND A STORYSCAPE	172
4.1	Comparison of <i>Lost</i> to Storyscape Concepts and Affordances	173
4.2	Analysis of the <i>Lost</i> Storyscape	179
4.3	Character as Focus for The Participants	189
4.4	Pleasures of the Medium: A Medium of Media, <i>Lost</i> as a Storyscape	193
5	DESIGNING A STORYSCAPE USING VOCABULARY, THEORETICAL AND PRACTICAL APPROACHES	207
5.1	Introduction: Designing <i>The Ghost Club</i>	207
5.1.1	Myth-Making and Mythology Documentation	212
5.1.2	Character	213
5.1.3	Canon	214
5.1.4	Genre	214
5.1.5	Ecosystem	214
5.2	Movie: <i>The Ghost Club: Spirits Never Die</i>	215

5.3 Webisodes: <i>The Ghost Club Girls</i>	217
5.4 Augmented Reality Stories and Games	220
5.5 Flash games: <i>TGC I</i> and <i>TGC II</i>	228
5.6 Websites: <i>Ghostpedia</i> , <i>The Ghost Club</i> , <i>TGC</i> on TV	232
5.7 Social Media	235
5.8 Theatrics.com	239
5.9 Summary Conclusions	239
5.10 Practical Conclusions	242
6 STORYSCAPE RESEARCH PAST AND FUTURE	245
6.1 Introduction	246
6.2 Summary of the Study	245
6.2.1 Overview of the Problem	246
6.2.2 The Evolution of My Model and Vocabulary	250
6.4 Identifying a Medium of Media, the Storyscape	254
6.5 Four Gestalts as Design and Analytical Practice	255
6.5.1 Myth-Making and Mythology	256
6.5.2 Character, Canon, and Genre	257
6.6 Next Steps: Additional Storyscape Research	257
6.7 Concluding Remarks	258
APPENDIX A: Glossary	261
APPENDIX B: The Ghost Club Storyscape Media Links	269
APPENDIX C: The Ghost Club Story Bible	270
REFERENCES	385

## LIST OF TABLES

	Page
Table 1: A Typology of media that affects narrativity	108
Table 2: Different media and the gestalt implementation on four dimensions	209

## LIST OF FIGURES

	Page
Figure 1: Jimmy comic online blog	10
Figure 2: Transmedia fields, academic principles, and examples.	27
Figure 3: Crosstransmedia story design	28
Figure 4: A Walt Disney Productions diagram	30
Figure 5: The storyscape medium, gestalts, and media	32
Figure 6: Gestalt example of multistability	53
Figure 7: The new <i>Star Trek</i> timeline	58
Figure 8: Transmedia economic approach	62
Figure 9: <i>Lostpedia</i>	69
Figure 10: Spock bobblehead toy	77
Figure 11: <i>Battlestar Galactica</i> series bible	130
Figure 12: <i>Defiance</i> transmedia show and game	135
Figure 13: Movie narrative charts	152
Figure 14: Relations between storyworlds in the <i>Star Wars</i> system	161
Figure 15: <i>Star Wars</i> timeline composition	163
Figure 16: Anakin's character evolution and events	164
Figure 17: <i>Star Trek Universe</i> timelines	166
Figure 18: Some of the elements of the <i>Lost</i> storyscape	179
Figure 19: <i>Lost</i> : The complete character web	190
Figure 20: <i>Lost</i> : Juliet and Sawyer connect in the past	192
Figure 21: Jack and Kate from <i>Lost</i>	195
Figure 22: Robert Pratten indicates the way various media interlock	197

Figure 23: Complete map of the island from the video game <i>Via Domus</i>	198
Figure 24: Screen grab from <i>Lost</i> of the map	199
Figure 25: Fan decoding of map. <a href="http://lost.cubit.net">http://lost.cubit.net</a>	200
Figure 26: The <i>Lost</i> Notebook	202
Figure 27: <i>Lost, The Game</i>	205
Figure 28: In this scene actors are seen having encounters	217
Figure 29: <i>Ghost Club Girls</i> web series	218
Figure 30: Early diagram of character arcs, plot arcs, and media timelines	219
Figure 31: Diagram showing multiple user story interactions	221
Figure 32: Illustrated wireframes	223
Figure 33: Screen capture of the app showing the revealing of the ghost	224
Figure 34: Using the <i>Haunted Planet</i> AR app	225
Figure 35: The ghosts inhabit the red highlighted area	226
Figure 36: An example of capturing evidence	227
Figure 37: <i>TGC I</i> showing device and ghost explorers	230
Figure 38: <i>TGC Detective Game</i> in the Gaslight Era of Doyle and Houdini	231
Figure 39: <i>The Ghost Club</i> website	233
Figure 40: Participatory section of the site	234
Figure 41: <i>Ghostpedia</i>	235
Figure 42: Jimmy Martin's fictional Twitter account	237
Figure 43: <i>Skeptics Diary</i> comic strip online	238
Figure 44: Ghost Club Facebook page	239



## SUMMARY

A storyscape is the new medium of storytelling. It originates in the model of transmedia storytelling defined by Henry Jenkins (2006a) in *Convergence Culture* and applied to *The Matrix* franchise. The storyscape medium is conceptualized from the author/designer perspective as four gestalts that create a whole from stand-alone parts. The four gestalts are mythopoeia, character, canon, and genre. This approach frames the authoring of this story-centric model in opposition to the design approaches of world-building or storyworlds. The four gestalts also provide an academic approach that unites theory and practice with a unified design vocabulary and an orientation toward the creation of a cultural and creative product that is defined as the storyscape medium.

Storyscapes, such as *The Star Wars* franchise or the *Marvel Universe*, consume the lion's share of our cultural capital (Johnson 2014). Therefore, the development of a consistent vocabulary, a design approach, and an understanding of how they create meaning and define worldviews is critical to our understanding and practice of a new medium (Dena 2009). This recently ascendant medium (Johnson 2014) evolved from the affordances of digital media and the aggregation and remediation (Bolter and Grusin 2000) of new and old media into a new medium. Starting with the frame of storytelling as a practice and previous aesthetic models such as *The Poetics*, this research charts the evolution of the storyscape medium across topics of academic transmedia approaches, principles, affordances, and the connecting or conceptualizing principles that act as gestalts.

As a central contribution, this work develops a design vocabulary employed in practice across multiple established media. Henry Jenkins (2006a; 2007b; 2010a) worked to establish and define this new medium as a practice of transmedia storytelling but he did not name it. The field is haunted by the multiplicity of story forms that challenge a consistent approach or terminology. For example, canon was explored and defined by Geoffrey Long (2007) as the unifying principle, and Elizabeth Evans (2008) has investigated character as another central element of the transmedia storyscape. These terms and others are refined and coupled with design affordances then applied to my transmedia research project: *The Ghost Club* storyscape. I apply and validate the storyscape design method through a methodology of “research through design” using the gestalts and affordances that define the medium.

A storyscape is a new, rich medium that can be authored and created with a common vocabulary. It implements the gestalts that allow us to design or imagine an expanded story medium with the breadth and power of an ecosystem that has the cultural descriptive capacity and meaning-making power of ancient religions and their extensive mythologies. It is an open work (Eco 1989), told across new and old media with their own affordances, that has the potential to be the most descriptive medium for approximating a complex narrative world without Aristotle’s beginning, middle, and end.

# CHAPTER 1

## INTRODUCTION

New media promoters tend to regard transmedial storytelling as something radically new and revolutionary, if not as the narrative form of the future, but historians can put this claim in perspective by pointing out the dissemination of Greek myth through various artistic media—sculpture, architecture, drama, epic—or, closer to us, the multiple modes of distribution of Biblical stories in the Middle Ages. . . . This kind of multi-media treatment is typically reserved for those narratives which are considered foundational for the identity of a group. In the age of globalization, the community-building function of narrative has been taken over by stories like *Star Wars*, *Lord of the Rings*, and *The Matrix*—stories that transcend linguistic, national, and religious boundaries.

—Marie-Laure Ryan, *Transmedial Storytelling and Transfictionality*

### 1.1 An Introduction to Transmedia Storytelling

Stories have been told in speech, pantomimes, dance, music, and text and further combined into new forms and layered into new media such as film, television, and now interactive devices (Mateas 1998; Murray 1998); Bolter and Grusin 2000). This has given rise to new fields of study that try to determine the relationship between a story in one medium, for example, a movie, and that story connected to another medium, perhaps a game. These works are told, extended, and remediated across new media with novel forms of interaction. Some academic works have focused on topics of intertextuality or remediation, while recent scholarship has talked about the exploitation of story and franchises across media and, most recently, the practice of transmedia storytelling in the context of digital media affordances. Academics such as Henry Jenkins and Christy Dena developed the theory of transmedia storytelling, and the practice has been legitimized by the Producers Guild of America (PGA) with a job category: transmedia producer.

Fueled by the profits of transnational entertainment companies exploiting characters and mythologies, this burgeoning field has become an important topic for the entertainment industry. The economics of old media is reconstituted across many new media and emergent distribution channels. Artists and creators have also welcomed this new field, as new media allowed new forms of expression that challenged the idea of a single work in isolation and expanded their artistic palate with participation and digital affordances. New affordances exploit participation, audience engagement, experiences, interactive games, extensions, and verisimilitude. Scholars have started analyzing the potential and relationships, as corporations and artists start expressing themselves in related ways across media.

The *Star Wars* and *Star Trek* franchises challenged the way we think about stories as they extended their characters and mythologies into sequels, prequels, movies, television, merchandising, and books. Franchises challenge traditional story models, often rooted in the linear story model articulated by Aristotle, with the explosion of new media into games, virtual worlds, fan fiction, online communities, Wookieepedia (a *Star Wars* wiki), and iPhone and iPod games. This model describes a well-formed plot first and characters second. Academics took up the challenge, using these two franchises as examples. Transmedia storytelling had existed before the concept was articulated; media theorists had been grappling with the development and cross-media expansion of these franchises for at least a quarter of a century. As we entered a new millennium, we started to see intentional examples of transmedia storytelling such as *The Matrix* and *Lost*. Henry Jenkins (2006a) pioneered the term *transmedia storytelling* to describe a new story model that had affordances never used previously to create a whole plot and story from disparate

parts. Traditional media limited you to a single role of reader or viewer, but this new model combines the roles of reader, viewer, participant, performer, and author. A participant can be a starship captain in *Star Trek Online*, a Star Trek MMORPG (massively multiplayer online role-playing game), and relate that to a movie or television series in progress while wearing a Star Fleet Academy t-shirt. To clarify and address these issues, this work proposes a design approach for the new medium of a storyscape.

A storyscape is the grouping of story-related works and communities across media. The storyscape must have an authorial voice (individual or communal) to determine the meaning-making systems of mythopoeia, character, canon, and genre. This grouping must contain original content—in different media not solely remediated or repurposed—that forms experiences or stories that become imagined as a whole text. A component of a storyscape may be remediated from one medium to another, as a novel to a movie, but most storyscapes are constituted of story parts that are additive or synergistic (Jenkins 2007b). The central aspect of storyscapes is to frame the relationship between the parts to the whole as gestalts. A storyscape is the sum total of all the media manifestations of a central mythology and also includes the community, cultural zeitgeist, and media artifacts that surround a storyscape.

In defining the storyscape medium, I start where Jenkins posits a specific medium of transmedia storytelling. The definition of the storyscape medium builds on Jenkins's (2006a, 95–96) definition of transmedia storytelling in *Convergence Culture*, “A transmedia story unfolds across multiple media platforms, with each text making a distinctive and valuable contribution to the whole. In the ideal form of transmedia storytelling, each medium does what it does best—so that the story might be introduced

in a film, expanded through television, novels, and comic; its world might be explored through game play or experienced as an amusement park attraction.” This model has been adopted in practice, as I will subsequently discuss. The definition of transmedia storytelling is diverse and disputed, but with transmedia culture being adopted by a mass audience, designers face new challenges different from designing for each of the individual media. Focusing on this single model of transmedia storytelling, this dissertation proposes a method to design and analyze the transmedial storytelling model defined as a storyscape.

To explore how to design this medium, I first proposed four design elements as connectors, later understood by me to be gestalts: mythopoeia, canon, characters, and genre. They are drawn from theory and practice in storytelling and fields of knowledge or media platforms contained within the transmedia discourse. The goal is to create an ecosystem for participants to transmit plot, stories, and emotions from one medium to another while keeping the sense of integration into a larger story, even if those relationships between the individual media are abstract or not connected by plot. The relationships between the elements of a storyscape are what make it potentially more immersive, effective, or compelling and, thus, merit investigation into how they connect into a cognitive whole.

## **1.2 Key Distinctions in Theory and Practice**

This work is distinct from most transmedia scholarship in three significant ways. First, it proposes a specific medium for study. Second, it proposes a story-centric design approach for that medium that contrasts with storyworld and world-building methods and literary models. Third, I define a vocabulary of four gestalts to describe that method that

defines a creative method in sync with academic analysis. This provides a method and analysis that works for both academics and authors focused solely on a specific model of transmedia storytelling, the storyscape. Finally, I seek to articulate the main topics and qualities of the storyscape.

Many of the theorists in transmedia storytelling have emphasized the importance of thinking about and creating storyworlds (Jenkins 2006a)(Johnson 2014). In the context of transmedia storytelling, this method has meant the physical world-building method but has also extended theoretically from an analytical frame of shared narrative worlds to a conceptual model to describe the universe of a group of related stories and their physical space. Marie-Laure Ryan's definition of storyworlds captures the current description.

This notion of storyworld is central to the phenomenon of transmedial storytelling, since it is what holds together the various texts of the system. The ability to create a world, or more precisely, the ability to inspire the mental representation of a world, is the primary condition for a text to be considered a narrative. This leads to the question: what is a world? Storyworld is a concept that makes a lot of intuitive sense, but it is very difficult to define in a theoretically rigorous way. World suggests a space, but story is a sequence of events that develops in time. Storyworlds, consequently, are more than static containers for the objects mentioned in a story, they are dynamic models of evolving situations, we could say: they are mental simulations of the development of the plot. ... I propose to define storyworlds through a static component that precedes the story, and a dynamic component that captures its unfolding....

1. An inventory of existents, comprising (a) the kinds of species and objects that

(a) the kinds of species and objects that populate the storyworld; (b) the cast of individual characters who act as protagonists

2. A folklore relating to the existents (backstories, legends, rumors)

3. A space with certain geographic features

4. A set of natural laws

5. A set of social rules and values

Dynamic component:

6. Physical events that bring changes to the existents

7. Mental events that gives significance to the physical events (i.e. the motivations of the agents and the emotional reactions of both agents and patients), affect the relations between characters, and occasionally alter the social order (Ryan 2012 p. 362-7)

Many of the theorists in transmedia storytelling have emphasized the importance of thinking about and creating storyworlds (Jenkins 2006a; Johnson 2014). In the context of transmedia storytelling, this method has meant the physical world-building method but has also extended theoretically from an analytical frame of shared narrative worlds to a conceptual model to describe the universe of a group of related stories and their physical space. I find this focus on storyworlds and world-building misdirected. The misplaced emphasis on storyworlds comes from looking at the surface of the media artifacts instead of toward the more significant intrinsic meaning or structure of the story, or catharsis, present in the storyscape medium. This frame is deceptive and seductive in the shining pleasures of visual or verbal iconography—expressed in the props, set dressing, and production design—and the contemporary illusion of seeing values and ideas reified into



products we can own. Brian Clark, (2012, on Facebook.com) in his post *Transmedia is a Lie*, scolded, “‘Story worlds’ are nothing more than the boring work of continuity management. ‘Story Bibles’ are just a pile of ideas you haven’t even executed yet.” Christy Dena (2012) contextualizes the term by pointing out, “If you’re playing transmedia bingo, ‘worldbuilding’ scores ten points and one of those little jelly desserts from the kitchen. It is a term used by just about every transmedia evangelist, and me in the early days.” The coordination of the production process regarding the production design of storyscapes does have a secondary relevance in how they are built, but incorrectly as an authorial process. Particular storyscapes, which, for the most part, can be considered fairy or fantasy stories, involve the building of imaginary worlds, or subcreation, as Mark J. P. Wolf (2013) has documented. The idea of the subcreation of these fantasy universes as described by Tolkien (1966) and extended by Wolf is secondary to the four gestalts in designing the storyscape. Furthermore, understanding the gestalts as the creation of the story within a fantasy world reflects the reader/participant’s ability to fill the vast unknown space of the imaginary world from as little or as much information as the creators provide. For Tolkien, the mythopoeia resulted in a story resolving eucatastrophe, existing in a fairy world that is subcreated from our own world, (Tolkien 1966) in contrast with the aggregation of Ryan’s static and dynamic components in her definition of storyworld.

In my approach, the central gestalt is mythopoeia or myth-making. For practitioners and theorists, the term *mythology* is often used to describe the method of myth-making in this medium. It is sometimes confused with the practice of creating a mythology for transmedia stories that contains the mythopoeia and other story arcs and documentation. I

will review both these practices in the following chapters. My approach clarifies the word *mythopoeia* for the practice of the storyscape by referencing specific theoretical models of mythology and reconciling them with the imprecise practice of myth-making in transmedia story development. Specifically, I apply the theoretical approaches of Campbell, Levi-Strauss, and Barthes to understanding myth and constructing or deconstructing mythic discourses within a storyscape or transmedia story. It is by understanding how storyscapes situate their myth-making within a subgroup's ideological and cultural worldviews or meta-narrative that makes these storyscapes resonant, relevant, and current. Fans want to look like a Vulcan with ears and Star Fleet uniform, and they want to be a part of the Vulcan philosophy, to enjoy its worldview and history and find the deeper meaning in the mythology. Starting with myth-making to find an engine of meaning, and extending to character to find compelling narrative arcs through media, aware of the ebb and flow of canon of dubious consistency, and the limitations and expectation of genre, this method offers a story-centric method. This is opposed to drilling into the taxonomies of world-building and a storyworld approach that offers us worlds to explore instead of stories that we can feel and create meaning through new and old dramatic structures.

My approach is also distinct from theorists who proceed from academic approaches that range from ethnology to literary analysis. These approaches yield results that are useful or illuminating, but not necessarily well suited to uniting theory and practice. This is because they focus on the qualities of transmedia storytelling from a categorical or feature-based view, such as Dena's four-way chart (Dena 2010) or Jenkins's principles of transmedia storytelling (Jenkins 2009b), instead of trying to understand how these new

stories work and provide narrative insights, worldviews, and pleasures to their audiences.

### **1.3 Design Study: The *Ghost Club* Storyscape**

The *Ghost Club* storyscape is a case study in applying the four design gestalts to connect different media artifacts of transmedia storytelling. To experiment with these four connector gestalts, I directed a combined research and artistic team to create a transmedia storyscape to explore the design process of the relationships and connectors (gestalts) between media. The ecosystem is called the *Ghost Club* storyscape, in which stories develop around a team of ghost investigators and the ghosts they encounter. It is composed of a movie, webisodes, websites, a mobile augmented reality game, Facebook pages, character-based Twitter feeds, comics, and Flash games. This system provides a platform to study how designers construct a story experience from a transmedia storyscape for participants. Below is an example of a webcomic that was part of the storyscape extending character across media and taking advantage of the formal qualities of each medium (see Fig. 1). In this case, it provides a window into Jimmy's character development that embodied the skeptic perspective and also offered the graphic pleasures of the comic medium to that audience.

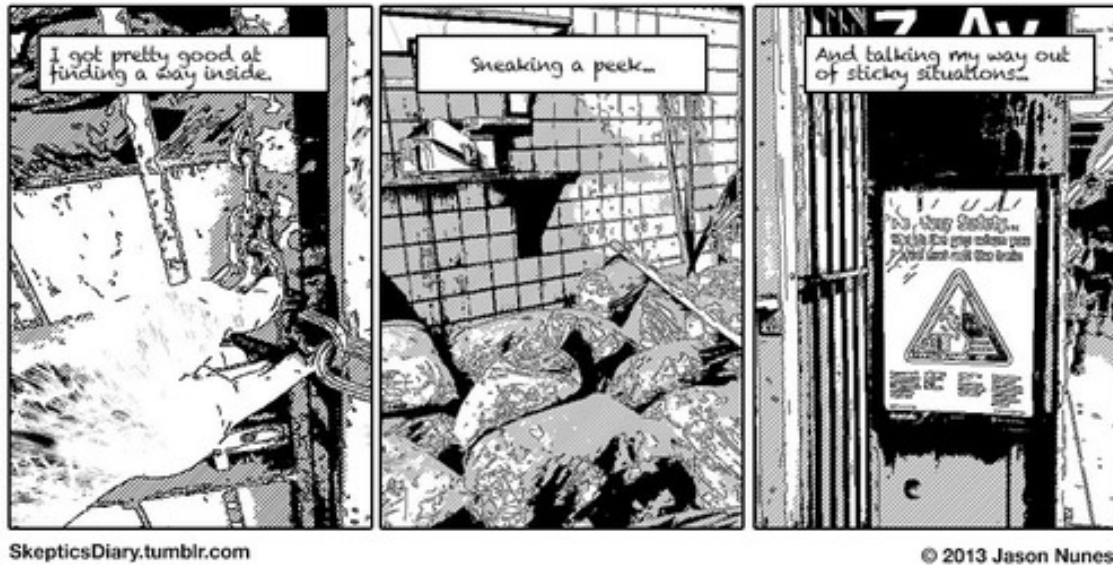

Figure 1 Jimmy Comic Online Blog. Jason Nunes, from The Ghost Club storyscape SkepticsDiary.tumblr.com

This thesis contributes to the research and practice communities by providing a starting framework and vocabulary for designing a storyscape. This framework includes the design gestalts that connect individual pieces of a storyscape into one unit. By drawing from the communities of theory and practice, I elucidate basic principles of creating a whole story whose complexity is greater than its individual parts. This whole is, therefore, capable of providing a more robust story model because it takes advantage of the new affordances of digital media such as embodiment and dramatic agency for a first-person experience. My investigation into weaving together all media targets understanding examples of the storyscape narrative model. A storyscape can match the cultural complexity of a large community of readers, users, and players that coalesce around that whole and use it to create an identity, make cultural landmarks, and participate in a new story model.

#### 1.4 The Storyscape Research Questions

Once a new medium of storytelling is described, and significant examples emerge, it becomes important to develop a vocabulary for the authors of the medium and theorists trying to understand its implications. Further, the very modality of stories in different media entails new requirements to understand the way those stories transcend an individual medium and unite in a gestalt that creates a whole from often disparate, even contradictory, parts. For example, while the *Star Wars* storscape has made pronounced efforts to unify its canon and mythology in its “Expanded Universe,” it recently repudiated most of this canon, moving it into another classification called “Legends” that is no longer considered canon. These new problems, methods, and aesthetics yield the following areas to research.

**R1: How do you design a storscape (a transmedia story comprised of different stand-alone elements, across media and extending into the real world) so that it constitutes a single coherent work? What are the design principles that sum these parts into a greater whole?**

I propose that a storscape, the object of study of a transmedia storytelling project, is a medium of media. It is the logical conclusion of other theorists and practitioners who have asserted that the emerging form of transmedia storytelling is a new narrative form worthy of study (Jenkins 2006, 2007b; Dena 2009). This question addresses design approaches for this new emerging medium that spans different production methodologies and cultures. This question further investigates the way this form of story is created across media and the differences that manifest in this new form. For example, a storscape more closely resembles a form of an open work as discussed

by Umberto Eco (1989) than the Freytag pyramid that exemplifies the Aristotelian model of narrative. The open character of the storyscape suggests that new design modalities of storytelling need investigation. These modalities are represented as gestalts that allow a unified conception of the work and involve an investigation of what it means for a story to exist inside and also outside of the media artifacts.

**R2: What are the significant connectors, affordances, or gestalts between two or more elements of a storyscape that can animate and contribute to useful design and storytelling approaches spanning different media practices and affordances?**

While the first question was how we sum the whole, this second question focuses on the way these gestalts in practice can contribute granular connections and how we achieve the parts. By defining these elements and analyzing how they work in the design process, I have identified useful story design paths and methodologies for further research and practice. I have tested the robustness of the gestalts I proposed: mythopoeia, character, canon, and genre. I have also explored how these connectors engage an audience across different media affordances and how they create the story meaning-making platform. Most prominent under this research question is the definition and analysis of how mythopoeia works in a storyscape. This will also illuminate how a story works within a transmedia discourse.

**R3: What is the design language of transmedia storytelling including a vocabulary and syntax required to describe and create the parts and relationships of a storyscape across media and the discourse about this medium?**

For both designers and theorists, a vocabulary of practice and theory needs to be developed and clarified to enhance the creation of new works and also to find a consistent way to describe novel forms of narrative interactions. Perhaps even more important is to develop a narrative vocabulary that moves beyond “the language-based definitions that are common fare in classical narratology,” as Marie-Laure Ryan aptly noted (Ryan 2006a, 7) and toward a vocabulary that can encompass an open work with new narrative pleasures that aren’t understood only in terms of the logical plots of movies and novels. But rather a focus is on in the ineffable story that arises from what is not seen or spoken but exists outside and across media in our negotiation with the story to create our imagined storyscape.

### **1.5 Steps to a Theory and Practice of the Storyscape**

My dissertation situates itself explicitly within the academic communities of transmedia storytelling, television studies, and digital media. There is also a convergence with the practice of transmedia storytelling as defined by the Producers Guild of America and explored through the methodology of *research through design*. I look at transmedia storytelling as an example of production culture, and the interaction of those multiple production cultures and methodologies is expressed in a medium of advanced media forms: TV, movies, games, and ARGs. What follows below are the process and steps I will cover in the subsequent chapters.

Before I started writing, my intellectual journey reflected a desire to create and understand new story forms that were arising. My interest has been in pushing the formal limits of storytelling, in particular along the path of modern examples that exemplify multiple discrete media such as motion pictures. My background in motion pictures led

me to the emerging model of transmedia storytelling as an extension or evolution of the motion picture storytelling model. I am interested in telling stories as a creator and an academic, and I am looking for practical approaches that align with my storytelling experience, and also academic descriptions that match the practical approaches. Driven by the disconnect in story theory between film studies and film production and seeing the integration of theory and practice in digital media, specifically transmedia storytelling, I was motivated to explore an approach that could span both ways of knowing. This investigation in unifying theory and practice follows in the footsteps of other transmedia theorists—including Lance Weiler (Weiler 2015), Christy Dena (Dena 2009), and Marc Ruppel (Ruppel 2012)—who are trying to find an integrated academic and artistic practice. It is also a salient and pressing question in the emerging field of digital media narrative.

The steps are addressed as follows. In chapter 1, the Introduction, I have outlined my approach, defined my field of inquiry, specified the research questions, and offered a brief preview of my theoretical model and research.

In chapter 2 I sort out the various philosophical, narrative, and transmedia academic issues into relevant topics, methods, and affordances for the storyscape. Framed by my definition of the medium and its goals, I use these as part of the storyscape design process. An example of an affordance of transmedia storytelling is using collective audience intelligence to solve narrative puzzles or audience participation as a design feature forming part of a storyscape. I also examine the practice of transmedia storytelling, largely by nonacademics, and the silos of individual practices that make up the stand-alone media elements of a storyscape. The goal is to map this analysis to the



academic theory to refine the vocabulary and consolidate a design approach. I look at two kinds of practice. The first aspect is a theoretical discussion of transmedia storytelling by critical, but not academic, writers who documented or discussed practice. This includes journalists such as Frank Rose (2012), who tackled many aspects of transmedia storytelling in his popular *The Art of Immersion*, as well as author/producer/writers such as Brian Clark (2011), Mike Monello, and especially Jeff Gomez (2014). They have written pro and con about the process and development of the practice in entertainment and advertising. As part of this investigation, the four gestalts were pulled out and highlighted as the design approach for unifying the whole work. They are examined and explained in Chapter 3.

Chapter 3 is the heart of my story-centric argument for the design of the storyscape. While I was looking for connectors or connecting plot structures, I arrived at gestalts as a by which a person can conceive a whole picture or story from a minimum of parts or data points. The notion of gestalts has proven more useful than mere connectors in articulating core story design methods. I develop my term *storyscape* and elaborate on the four gestalts of design of a storyscape: mythopoeia, character, genre and canon. These gestalts engaged participants in a negotiation to create their story from the disparate elements across stand-alone media—often a subset of the entire work. As part of the research, I participated in the communities of practice and the discourse of transmedia production culture that is carried on in forums, Facebook, websites, and transmedia meet-ups in New York and Atlanta. From this practical research, coupled with my theoretical research, I refine a design theory and vocabulary that grapples with how to create a story that works across media, engages its transmedia affordances, and draws from real-world

practice and theory.

In chapter 4, I look at *Lost* and its transmedia permutations through games, ARGs, and user participation as an exemplar of a storyscape. This shows how some of the gestalts and affordances play out in this work across media. In the course of this research, I also looked at the *Star Wars* storyscape, the *Star Trek* storyscape, and the many other developing examples of transmedia storytelling, from Henry Jenkins's exemplar *The Matrix*, to the new television show *Defiance* and its transmedia companion game. These examples are reflected throughout chapters 2 and 3 and inform the discussion of the storyscape medium throughout. *Lost* engaged audiences and scholars across these new affordances and methods, and the four gestalts. I work to integrate the model I am proposing through a close reading of *Lost* and my first-person experience of participation and viewing.

In chapter 5 I apply these elements and the principles I developed from my research to my own storyscape project in order to test my approach and vocabulary. This approach was communicated to all the participants and codesigners of the various works contained within the *Ghost Club* storyscape. Then through the interaction of the creative process, various media methodologies, and the theoretical design process, a matrix of works was created to explore the premise and result of this ecosystem. Only through the development of myth-making, a canonical structure, character arcs, and genre expectations could the design process be tested to reflect back on the critical understanding. The design process gave rise to a revised, and refined, method that reflected back into the analysis of theory and practice in a recursive model to refine theory, methods, useful principles, vocabulary, and approach. This approach is focused

on understanding story, in the storyscape medium, over commercial and economic concerns. It highlights the applicability of these transmedia story gestalts in media and forms where the gestalts are partial or not represented. This approach (the storyscape medium, its four gestalts and a set of affordances) work as a storyscape design method. It connects to the academic discourse so theory and practice can be discussed with a shared perspective and language.

By applying theoretical and critical approaches to the emerging practice of transmedia storytelling, *research through design* contributes to further research into practical design and aesthetics. I discuss qualitatively the effectiveness of this approach on an audience. Also, the crew's feedback and documentation is considered against the storyscape design approach. However, the purpose of this research process is to mix the subjective design of storytelling with the physical design practice across discrete artistic products. Therefore, these subjective audience expressions about the effectiveness of these connections are not the end goal of this research. The goal is two-fold, first to design an approach, reflected in the four gestalts, for the storyscape medium and then to implement that story-centric approach in order to understand its use in practice.

## **1.6 The Storyscape Medium**

This storyscape medium is critical to understand for many reasons. One is that this medium extends its reach through an expanding series of affordances and thus is potentially more immersive and resonant, individually or culturally, than a single medium can achieve. Audiences have come to love and appreciate the immersion that comes with transmedia experiences, such as when they participate in a *Lost* alternate reality game between seasons, but that medium-specific pleasure may have downsides. Too much

immersion may entail the loss of connectedness to the real world as more time is consumed in these storyscapes and the proliferation of products. Or this approach can be applied to propagandize across media with a unified mythopoeia and stories that convey a dubious worldview repeated through media that is more emotional than logical. The goal of many storyscapes is totalizing. For example, the transmedia affordance of verisimilitude that merges the storyscape into the real world with a one-to-one diegetic relationship also signifies a limitless story space and longer hours of engagement. Economic synergies encourage expression across all media for revenue or marketing. In the world of *Rainbow's End*, the novel about augmented reality in the future by Vernor Vinge (2007), there is see a complete overlay of fiction with reality where the reality of living in a narrative fantasy world all the time can be imagined as a storyscape taken to its extreme. A storyscape is worth investigating because, like the *Star Wars* storyscape, it functions like a cultural subgroup, almost a religion, providing identity and consuming vast cultural resources in the form of big-budget movies, games, television, advertising, and merchandise.

On the positive side, new forms of stories can allow us to leverage those affordances to create more immersive, more pleasurable, and more sensually diverse paths through stories. This is as Janet Murray (1998) anticipated in *Hamlet on the Holodeck* when she outlined the narrative possibilities of her four qualities of a converged medium. New affordances may also yield experiences that will be customized to the interests and pleasures of the participants, as evidenced by Henry Jenkins's discussion of the emerging Harry Potter theme parks and experiences (Lønberg and Rasmussen 2011). Opportunities to view different aspects of a story could be educational

as added layers of information to emotional experiences. We can literally put ourselves in someone else's shoes, a favorite character, by experiencing what the character would in the first person. You can grasp Harry Potter's wand in your hand and own it at the Diagon Alley in *The Wizarding World of Harry Potter* portion of the Universal Theme Park (Jenkins 2010b). This could make a participant more empathetic with another's point of view. Finally, we can speculate that storyscapes are more complex, with all the affordances media provides, and these ways to create meaning across media can become more immersive, more resonant in our mental lives, and perhaps capable of supplying a more accurate narrative to live our lives and animate meaning in our culture.

But that robustness may come at a loss of comprehension, as we struggle to make sense of a work that has no closure and different points of view. The risk is that we may lose some essential clarity in our understanding of the world by supplanting the binary structure of most mythic narratives that resolve a single conflict, or binary opposition, into a single truth. If narrative moves to a medium that is open and doesn't give us fixed conclusions or a clear authorial voice, then it erodes simple resolutions and the fixed catharsis of the traditional story.

The significance of a storyscape is found in two distinct approaches brought to bear on this research project to create a story design method and analytical model through an examination of the ecology of a storyscape. The first is to embrace a new story medium that is the sum of many media and, therefore, has a greater field of affordances related to our different ways of knowing the world and being in the world. The second is that the poetics of storytelling are shifting from the closed text of Aristotle to an open ecology, like Umberto Eco (1989) defined in *The Open Work*. This is exemplified by the

user participation component of the *Lost* franchise and the ongoing games, extensions, and serializations of the *Star Wars* universe. A storyscape may be a transitional medium, or it may be short lived, but *Star Wars* and the *Marvel Universe* are planned out for another decade at least as the pulsing center of our American culture. Transmedia storytelling may be vague and diverse, but this medium, the storyscape, is the dominant medium of the early twenty-first century.

## CHAPTER 2

### THEORY: TRANSMEDIA THEORISTS AND OTHER THEORETICAL ELEMENTS OF THE STORYSCAPE

The goal of this chapter is to examine the significant theoretical and academic writings that have engaged with the field of transmedia storytelling. Next, I intend to derive a unified set of topics and affordances that can then be applied to the analysis of practice and examples. Many of these theorists comment on a particular model of transmedia that can be seen as an acknowledged medium: the transmedia storytelling of Jenkins, the franchises of Long, and the complex television of Mittell. These are the steps lead me to the codification of the storyscape as a media. I would remind the reader that the focus of this research is the specific model of transmedia storytelling that has significant examples including *Lost* and *Star Wars*. My goal is not to treat the entire field of transmedia or transmedia storytelling though scholars and artists have ranged widely in their discussions. Rather, it is to derive a method to explore a story across media-centric design as opposed to critical, theoretical, or single affordance-centered theories. To that end the following organization follows the central terms and ideas developed in transmedia discourse, associates them in groupings of like topics, and discusses their application to a storyscape.

#### 2.1 Structure of this Literature Review

The purpose of this review and analysis is to define the area of research, and then follow that up with significant methods, qualities, aesthetics, and theories that are most

relevant to this story-based approach and the storyscape medium. Then, I address the affordances or qualities that are part of the design process. Donald Norman in *The Psychology of Everyday Things* defined affordances as “the perceived and actual properties of the thing, primarily those fundamental properties that determine just how the thing could possibly be used.” (Norman 1988, 9) The four gestalts are reviewed and elaborated in the following chapter. First, I will discuss the early *Matrix* model as defined by Jenkins (2006a), who also introduces core concepts, methods, principles, and vocabularies that are integrated with the later work in the following sections. Then later work looks at topics and vocabulary that are useful, or should be considered, for designing a storyscape. This is followed by a discussion of design affordances elaborated by various academic authors and transmedia authors and their contribution to storyscape design. This review sets up the following chapter where I delve into the four gestalts of transmedia storytelling that other theorists have addressed separately, incompletely, or not necessarily from a design perspective.

## **2.2 The Storyscape, a Definition, and the Relationship to Transmedia Storytelling**

Transmedia storytelling as a form has become increasingly significant to owners of intellectual property, because distribution through complex franchises of stories, games, and environments has become a hugely profitable business (Long 2007). The challenge to traditional media by these connected elements, delivered through a profusion of media devices with unique affordances, has grown as new media platforms, such as mobile viewing, gaming platforms, a ubiquitous Internet, and computers as a creative medium, are adopted. Growing revenues encourage experiments in this emerging story



content model and creators take advantage of the new affordances of digital media, such as participation, multimodality, and procedurality. These fresh affordances of story provide artistic and economic opportunities to create a media form that relates stories, games, and environments but also requires a design approach that can knit these elements together.

*Storyscapes*, a term coined to clarify the transmedia model researched here, are a recent development in storytelling concurrent with the rapid development of new and converged media. Henry Jenkins coined the term *transmedia storytelling* to define the sum total of *The Matrix* movies, games, and other works. *The Matrix* transmedia storytelling landscape, which I call a storyscape including sequels, prequels (*The Animatrix*), and games, was designed explicitly to extend a single story across this tapestry by the Wachowski siblings (Jenkins 2006a). Since then Jenkins (2010a) and other media theorists (Dena 2009; Mittell 2009) have extended the definition of these connected stories and experiences to include, most prominently, *Lost*, the *Harry Potter* franchise, and retroactively, and going forward, the *Star Wars* and *Star Trek* franchises.

### **2.3 The Definitions of Transmedia Storytelling and the Storyscape Medium**

[Brian Clark's] presentation at our Futures of Entertainment conference at MIT, where he challenged many of my own assumptions about what forms of transmedia was important, following a lecture where my focus had been on Hollywood entertainment examples, by suggesting that his own approach was diametrically opposite of mine, and then, utterly convincing me with his arguments.

—Henry Jenkins, forum post on Brian Clark's Facebook page

Jenkins's quote above highlights the changing nature of the field of transmedia storytelling. The term *transmedia storytelling* has many different definitions and a changing scope of the field. Key theorists evolve, new artifacts are added, and lack of agreement on what is meant by transmedia storytelling has given rise to different

approaches. Some scholars, such as Lance Weiler at Columbia University and Christy Dena in her dissertation and subsequent practice, work to unify these potential divergent paths under a broad umbrella that contains all things transmedia. This could be storytelling through the “Internet of things” or educational content using multiple media or the original franchise model. The original franchise model was expressed by Henry Jenkins (2007b) in “Transmedia Storytelling 101”: “Transmedia storytelling represents a process where integral elements of a fiction get dispersed systematically across multiple delivery channels for the purpose of creating a unified and coordinated entertainment experience. Ideally, each medium makes its own unique contribution to the unfolding of the story. So, for example, in the *Matrix* franchise, key bits of information are conveyed through three live action films, a series of animated shorts, two collections of comic book stories, and several video games. There is no one single source or ur-text where one can turn to gain all of the information needed to comprehend the *Matrix* universe”. This quote has launched scholarly articles and dissertations that investigate a transmedia storytelling that started with a clear model and examples and now lacks any clarity.

I will return to a model that is derived from Jenkins’s original conception to achieve clarity and consistency of method and limited to specific examples. I want to clarify what a storyscape is within the larger context of transmedia storytelling and eliminate a confusion of terms and definitions in this field. What is transmedia storytelling? Basic transmedia terms and definitions are not clear or are used without consistency. Despite the growing field, expanding academic studies, and a proliferation of examples that indicate new media forms, the general terms and discussion of the field are handicapped by an inability to engage clearly with the salient issues because of too

much scope. This is because there is no language to describe the area at its category levels nor is there any agreement on categories. While Henry Jenkins spells out a specific model (Jenkins 2007b), he also engages across the spectrum of transmedia, speaking to a diverse range of views and topics undercutting his definitions (Jenkins 2010a). And despite his clarifications and specificity, other practitioners and scholars use words that mean many different things but also cover a diversity of exemplars to the point that nothing useful is contributed to discussions. Many academic approaches, from this point of view, fail because they are too inclusive and, therefore, do not identify clear issues in specific categories or narrative models.

Beginning at the beginning, what is transmedia? The word *transmedia* carries a wealth of disinformation with it because it can refer to almost anything within the digital media universe. At its most minimal use, it often used to define any story or story-like artifact that involves two or more media (Dena 2009). A newspaper article with an interactive graph online is transmedia. So is a television show with a second screen application to use online in concert with the show. Not specific to narrative forms, transmedia encompasses a diverse amount of narrative, journalistic, advertising, and artistic expressions (Dowd et al. 2013). As such, transmedia, with this unlimited definition in mind, can include most work being done in digital media storytelling and interactive narrative.<sup>1</sup> Before the term *transmedia* was used, areas of inquiry included cross-media (Davidson et al. 2010) or multimedia and most anything that was so labeled could also be called transmedia based on the simplest and commonly used definition of

---

<sup>1</sup> Transmedia can also be artistic or educational content as well.

more than one media. Additionally, it is routine to add the terms *story* or *storytelling* to the “two or more media” definition of transmedia, yielding the confusing use of the term of *transmedia storytelling* that is neither the Jenkins nor the ARG definition. From this point of view almost any interactive narrative or social media advertising endeavor is a transmedia story and forms the new field of study.

The following diagram (Fig 2.) situates the definitions of transmedia storytelling and where the proposed storyscape medium is contained. At the broadest definition transmedia is communication through any two or more media. Transmedia storytelling is defined by the addition of storytelling, but also the diagram represents academic and practical models that fulfil this broad definition. This also has formed the basis of disagreements as to what constitutes transmedia storytelling. The dark grey area of transmedia storytelling represents the *Matrix* model originally proposed by Jenkins and expanded on by theorists focused on the Hollywood franchise examples. The final square represents the storyscape. This defines the medium explicitly through affordances, style, and a coherent set of models so that it can be examined without the confusion of extraneous examples, affordances, and models.

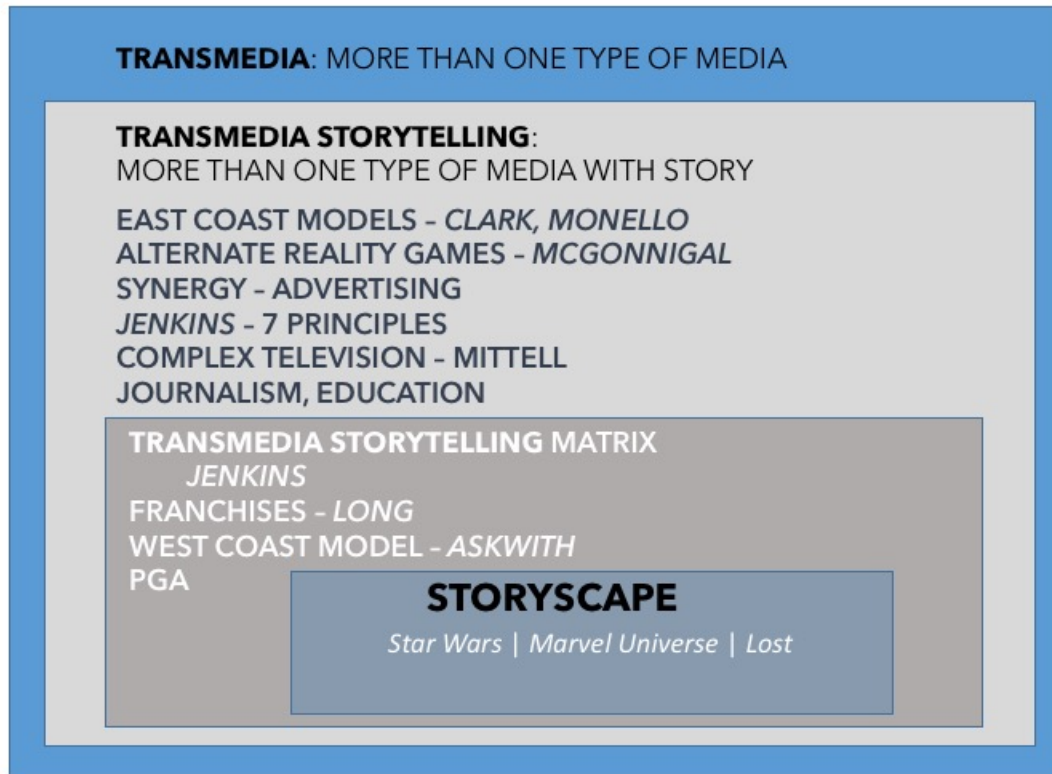

**Figure 2 Transmedia fields, academic principles, and examples.**

Christy Dena uses the following diagram (Fig. 3) to illustrate some of the earlier differences in transmedia thought and the areas of inquiry. For her, all four areas are within the domain of transmedia storytelling. On the right side, she identifies the transmedia project, made of two media, that corresponds to the broadest definition of transmedia storytelling. Moving counter-clockwise around the diagram, she identifies the transmedia concept, which distinguishes itself as being conceived as a unified piece. This could be an ARG, an educational game, or *The Matrix*. Next, she identifies the transmedia franchise predicated on the exploitation of that franchise across media. Finally, she identifies the transmedia transformation, a model such as *Star Wars* or *Lost*, that expands into a greater whole through extensions. These may be helpful categories in

the context of the broader field of transmedia but also illustrate the vast number of examples that fall into the broader definitions of transmedia storytelling.

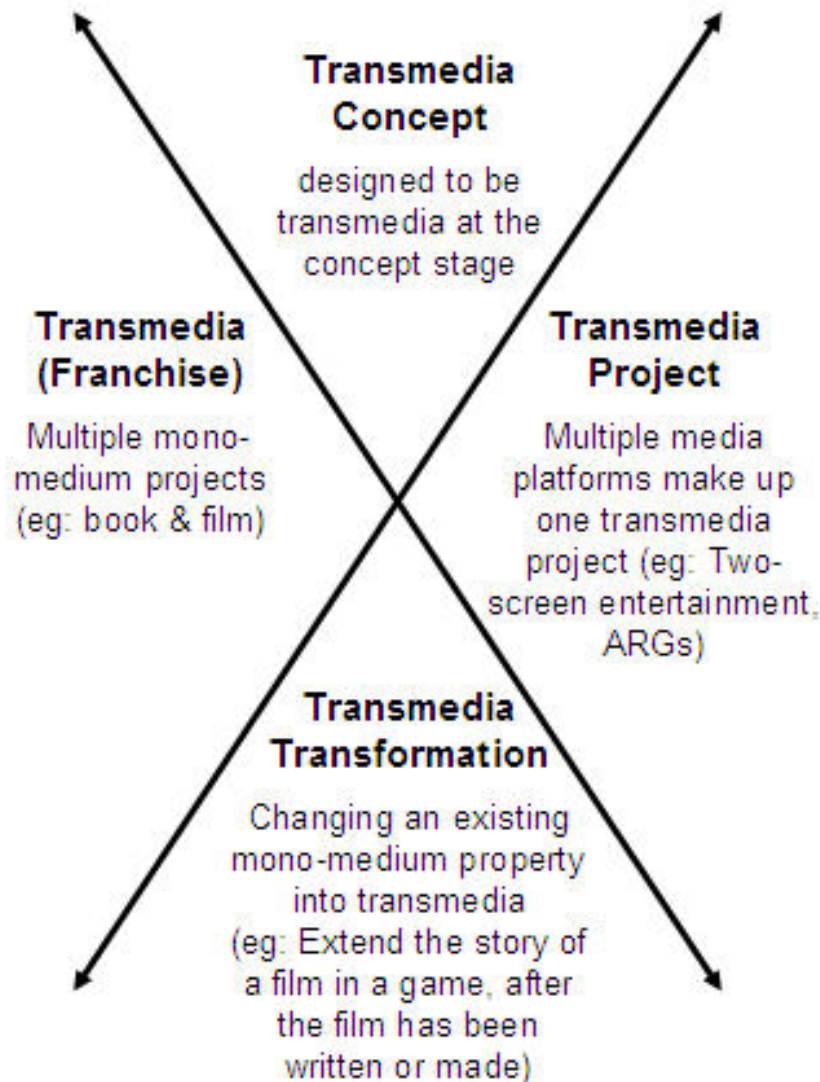
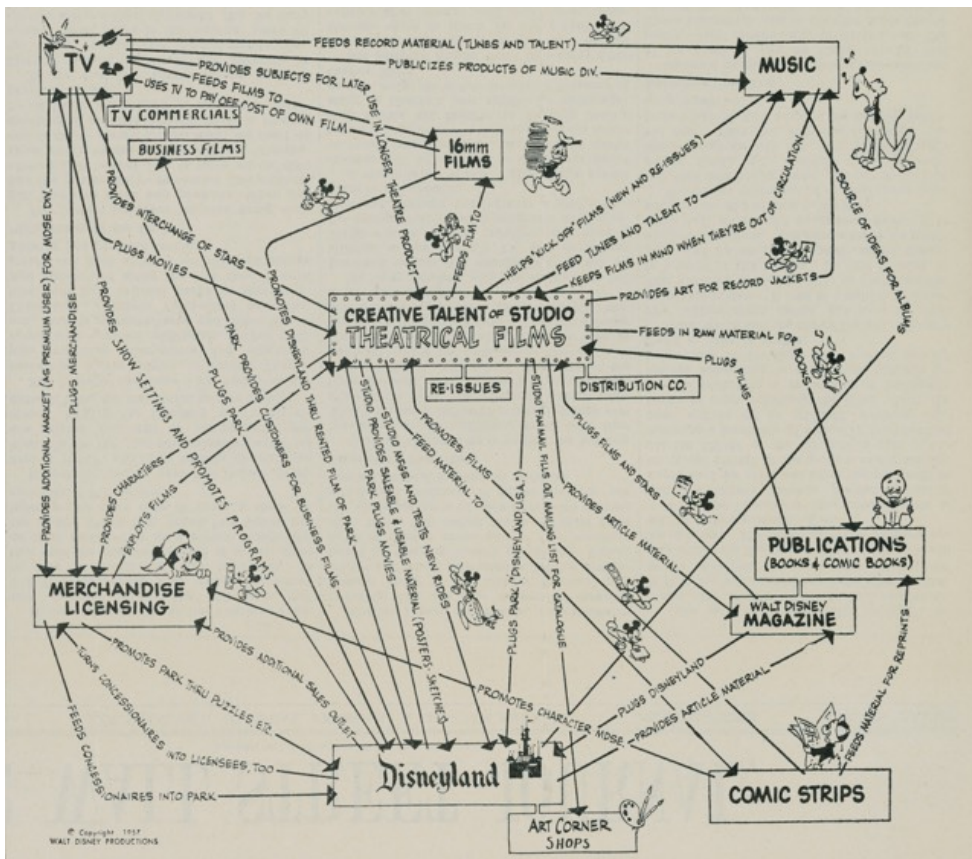

Figure 3 Crosstransmedia Story Design. Christy Dena (<http://www.slideshare.net/christydena/crosstransmedia-story-design>)

Consequentially, we have three general definitions of transmedia storytelling that we can use to drill into the specific model addressed here—the storyscape. Because the transmedia storytelling field is elastic, the definitions and media artifacts change

frequently. The three definitions scale from a broader to a narrower frame. As I have noted previously, there are rules that define the storyscape model, whereas the other transmedia storytelling models start with less definition. First is simple transmedia (also sometimes called transmedia storytelling), which indicates more than one medium is at work but otherwise describes a broad swath that includes almost all transmedia story experimentation. This is roughly equivalent to Dena's transmedia approach to describe a wide transmedia aesthetic. Brian Clark and Mike Monello define: "'transmedia storytelling' as the label for when you're creating a story as the primary storytellers and intending to tell your story across multiple channels" (Clark 2011), but this is in the context of a post that rebels against the Jenkins and Producers Guild definition. Memes that were started included #antitransmedia and "bacon is the new transmedia." This first area of transmedia storytelling is the Wild West of experimentation and definitions are not applicable. In the chart above, this is the transmedia project. In the diagram (Fig. 4) below from Disney, we can see how early this multimedia approach was conceived.



**Figure 4 A Walt Disney Productions diagram showing the relationships between the properties. Many transmedia artifacts were already present.**

Second is a category of transmedia storytelling that has a more explicit relationship story and has characteristics of transmedia storytelling identified in practice and theory such as collective intelligence, multiple media, verisimilitude, or extensions. This can include something that inhabits Dena's other three categories or, for example, an ARG, and theorists such as McGonigal tout that model as paradigmatic for transmedia storytelling while it is not accepted in the third West Coast model, which becomes the storyscape medium. The third use of the term *transmedia storytelling* conforms to a list of requirements indicated by Henry Jenkins in formulating a model for a new medium



and the Producers Guild of America (2010). These definitions involve narrowing subsets of transmedia artifacts from the most inclusive of transmedia models to a fairly rigid definition of that model and its examples—a model I build on for the storyscape definition. Jenkins (2011a), Askwith (2007), and Long (2007) would include an ARG as an element of a transmedia story but not see it as being sufficient to fit a definition of multiple stand-alone elements. The Producers Guild (2010) specifies that that a “Transmedia Narrative project or franchise must consist of three (or more) narrative storylines existing within the same fictional universe.” Both exclude adaptations and repurposing of material as not being a transmedia story with the PGA, stating: “These narrative extensions are NOT the same as repurposing material from one platform to be cut or repurposed to different platforms” (Producers Guild of America 2010). These requirements speak to the emerging transmedia Hollywood franchise model that applies to movies, and also complex television. I underline the necessity to name and research this specific model and subset of transmedia storytelling because otherwise this creates an aesthetic category, a medium, and a that is a disconnected group of diverse and medium specific artifacts.

The diagram below (Fig. 5) shows the relationships between various constituent media and the medium of the storyscape. At the base are stand-alone media—games, movies, and complete media with closure—these funnel up to the four gestalts depending on the affordances of each medium to communicate mythopoeia, character, genre, and canon. The whole of these gestalts and these stand-alone media results in the storyscape medium.

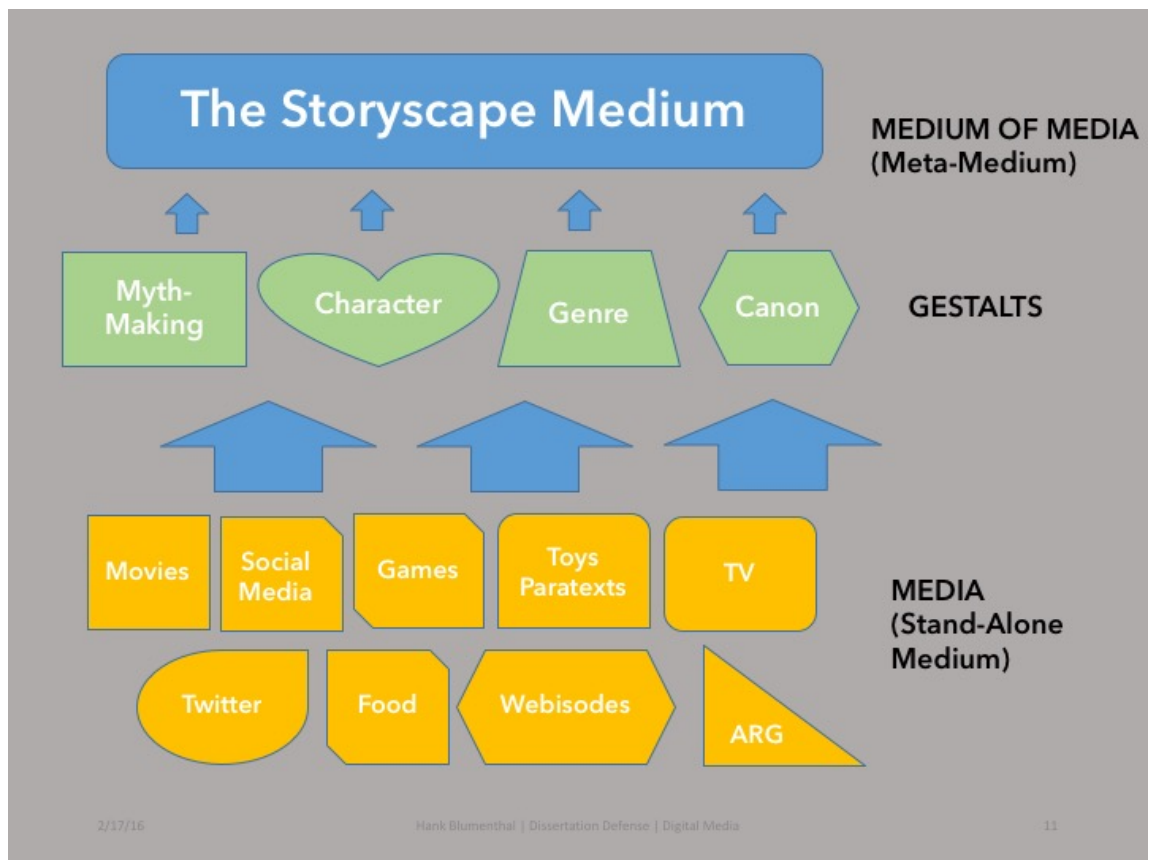

**Figure 5 The storyscape medium, gestalts, and media**

My definition of the storyscape aims to dispel confusion, carve out a thriving medium, and narrow my design research and vocabulary. My definition starts with the Jenkins and the PGA descriptions but I name the artifact created by the process a *storyscape*. The development of these large transmedia storyscapes can be identified as an evolving medium with an emerging production process and aesthetic. The body of work, including *Star Wars*, *Lost*, *Matrix*, and *Walking Dead*, create a new category of artifacts that can be named and examined. These artifacts have been identified as a medium, but not named, by Jenkins (2006a) or Frank Rose (2012) so we have a specific process, transmedia storytelling, with a set of elements and affordances that define the

artifact but leave us struggling to discuss it as a category without a name like a novel or movie.

I use the term *storyscape* to resolve two issues. First, by naming the storyscape, I narrow the field of research to the defined model so that it can be studied and researched without confusion with many other artifacts that only share partial modalities or affordances. Thus, the naming creates a body of works for analysis. It would be hard to discuss writing and understanding novels if we also included movies in our definition of a novel, so by limiting this approach and analysis to this subset of transmedia examples, a more coherent approach and analytical schema can be extended into a proposed authorial and production process along with a unified vocabulary.

Second, this consolidates and codifies a production and academic language, within the context of this model. These examples can be used to create a storyscape for research or art by defining the terms of an analytical or creative discussion. When I speak about a storyscape, I am referring to the specific franchise transmedia storytelling models referenced by Jenkins in his early works attempting to define a new medium, Ivan Askwith in his work on *Lost*, and Jeff Gomez in his practice in introducing the PGA definitions and roles (Jenkins 2006, 2007b, 2010a). For example, a storyscape may have participation, a hallmark of transmedia storytelling, but it is not an adaptation or repurposed material as stipulated by Jenkins and the PGA.<sup>2</sup> This definition allows the

---

<sup>2</sup> Interestingly, *The Ghost Club* storyscape was submitted to the Tribeca Film Festival in 2011 with descriptions of the term and the first paper and presentation defining the medium. The following year the New Media portion of the festival was named Storyscapes, which it defined as any model of transmedia including multimedia installations.

investigation of a specific design approach for these franchises and narrows the definition of the field of artifacts.

### 2.3.1 Henry Jenkins and *The Matrix* Model

Henry Jenkins (2006) explored transmedia storytelling in the chapter, “Searching for the Origami Unicorn,” from *Convergence Culture*, explaining *The Matrix* as the best example of this new story form he called *transmedia storytelling*, a model that I call a *storyscape*. The Wachowski siblings’ singular pursuit in creating a storyscape across three movies, games, a MMORPG, and an animation series created an exemplar for transmedia storytelling as the storyscape medium. Jenkins (2006) charts how *The Matrix* storyscape distributed meaning and cues across media, and he suggests transmedia storytelling requires an audience to be in the know regarding different media and assemble a single story across media artifacts. Furthermore, it requires the audience to participate and sometimes work for a broader understanding of the whole. “No film franchise has ever made such demands on its consumers”, Jenkins (2006a, 94) notes, talking about *The Matrix*. The same can be said for *Lost*, a storyscape example from television discussed in Chapter 4. *Lost* placed solutions to many narrative puzzles posed in the principal medium—episodic television—embedded in other media. In turn, fan communities used crowdsourcing to solve puzzles or find new cues. Crowdsourcing in this instance refers to the coordinated work of viewers/fans in forums on the Internet, who communicate to decode cues, unlock answers hidden in other media, and synthesize information from multiple sources to determine story causality. Jenkins (2006a, 95) points out: “*The Matrix* is entertainment for the age of media convergence, integrating

multiple texts to create a narrative so large that it cannot be contained within a single medium”. This is a starting model for the new medium of the storyscape.

### **2.3.2 Transmedia First Principles and Main Topics**

Transmedia storytelling is a term whose use and definition is much debated, as I outlined in Chapter 1. Nonetheless, Jenkins’s (Jenkins 2007b) definition, outlined above, forms the crux of the storyscape research domain and also distinguishes this model from the various forms of transmedia storytelling discussed in Chapter 1. This is the definition of transmedia storytelling from which my definition of a storyscape medium is derived.

Jenkins’s definition describes a process for telling a story across media that has emerged from new digital media forms, such as video games, and also economic developments, such as franchise universes. It implies a new medium when it uses *The Matrix* storyscape to describe an artifact—composed of many stand-alone media elements—that represents a “unified and coordinated experience.” Jenkins and Dena categorize this as a medium with unique, recognizable characteristics. For Dena (2009), this is illustrated in her discussion of aesthetics for transmedia storytelling that distinguishes a broader approach, with more possible models, contrary to Jenkins. “This thesis [Christy Dena’s] does not, therefore, focus on a certain type of transmedia practice such [as] pervasive games, ubiquitous games, alternate reality games, augmented reality games, two-screen entertainment, ‘franchises,’ networked theatre, or installations” (Dena 2009). Jenkins’s model, often described as a movie or TV mothership model with transmedia extensions, and also adopted by the Producers Guild of America, has an explicit set of requirements and prohibitions that allow a progression to the storyscape medium definition.

Geoffrey Long (2007) also defines the model and area of his inquiry as transmedial narratives with specific franchise examples that embrace the storyscape model, but without naming a medium. Beyond a focus on captivating characters to engage audiences, he emphasizes the shift to “captivating universes” to catch, and hold, the interest of audiences. Leaving aside Long’s storyworld model of canon, it is important to note here that he describes explicitly and exclusively a franchise model of storytelling that is coextensive with the form I call a storyscape. Specifically, it also excludes many stand-alone elements, like an ARG, or two-part forms of transmedia storytelling described by Dena and others in the transmedia community in favor of examining the model posed by Jenkins.

Jenkins clarifies the relations between parts explicitly. To further refine the formal qualities of this new medium, Jenkins (2007b) writes on his blog *Confessions of an Aca Fan* in a post entitled “Transmedia 101”, “integral elements are distributed across multiple delivery channels . . . each medium makes its own contribution to the unfolding story.” This speaks to the particular model of transmedia storytelling that uses multiple media but is still about a unified whole created of stand-alone parts. Further, as he goes on to use the *Matrix* exemplar, he is talking about specific instances of the “integral elements” in the way that it comes together from independent media such as a *Matrix* game. The coalescing of these elements into a medium is discussed in more detail later. I adopt Jenkins’s model, with small adjustments, to achieve coherence; however, the vocabulary remains challenging, inasmuch as transmedia storytelling in academic and practical usage means many different things. Dena (2009, 35) notes in her dissertation, “it is important to clarify that the media studies theory of transmedia storytelling, the use of

transmedia in this thesis, and the narrative studies theory of transmedial narrative are not analogous concepts.”

Using Jenkins’s definition and examples, including *The Matrix*, identifies a medium along the lines of the movie franchise model or complex television, but it fails to name the medium. The “mothership model” defines franchise transmedia storytelling where the core text is a movie, television series, or sequence of movies surrounded by games and other media forms. Brian Clark (2011) called this the West Coast model. Jenkins has described a medium, with a set of specific principles that Long and the Producer’s Guild recognize. Academics also describe this medium, starting at Jenkins’s definition, to criticize or extend. Jason Mittell quotes Bordwell regarding complex television, “narrational mode is a historically distinct set of norms of narrational construction and comprehension” (Mittell 2006, 29); Mittell (2006, 29) extends that thought in reference to complex television to describe a medium as “one that crosses genres, specific creators, and artistic movements to forge a coherent category of practices.” This is applied to *Lost* and examples that fit the storyscape model.

Adding further practices and exclusions to the medium I call a storyscape, Jenkins (2007b) stipulates, “Ideally, each individual episode must be accessible on its own terms even as it makes a unique contribution to the narrative system as a whole.” The idea of a stand-alone piece of content that must engage in the language of that medium extends throughout the discussion of Jenkins’s model. A comic book story must first and foremost be a good comic book with a self-contained story told mostly in that medium that fulfills the specific pleasures of that medium. In the case of a comic, that would be elements such as skillful or expressive drawings, with an engaging narrative. It can’t be

an inferior work or fail to meet the pleasures of the medium and still contribute substantially to the overall effect. The pleasure of the medium is the economics of content: people will “spend” their time on content that gives them the pleasures of each medium. An object lesson for this rule is the video game for *Lost*. It added to the overall transmedia story, but failed to engage players in the video game medium, substantiated by the poor consolidated reviews on *Metacritic*. Thus, it rarely figures prominently in discussions of the *Lost* ecosystem of story.

Christy Dena (2006) draws a sharp distinction with Jenkins about the scope of transmedia storytelling and, in particular, the requirement of stand-alone elements: “More and more stories will be told in the transfiction style. By transfiction, I refer to stories that are distributed over more than one text, one medium. Each text, each story on each device or each website *is not* autonomous, unlike Henry Jenkins’s transmedia storytelling. In transfiction the story is dependent on all the pieces on each medium, device or site to be read/experienced for it to be understood. Basically, no single segment will be sufficient.” Dena proposes a different medium, the transfiction style that contrasts with the narrow focus in this document of the storyscape model. For the purposes of this research, Dena, Rose, and others include too many new and emerging models, which exhibit different qualities and characteristics, to allow a productive analysis of a story-centered design approach.

One other established medium that I mentioned previously that fails the stand-alone test is the alternate reality game because its parts are only incomplete pieces of the whole transmedia story. In the broader transmedia storytelling community, there is a controversy around ARGs because of the competing definitions of what constitutes



transmedia storytelling. They are considered a new transmedia story model distinct from the storyscape model outlined here. As Ryan (2012, 14) observes, “When ARGs are used as part of a transmedial project, they function as one of the many platforms through which the storyworld is realized. But ARGs are also inherently transmedial narratives because they tell stories, and they do so by using a diverse range of existing delivery systems: websites, email, SMS messages, GPS, phone calls, posters, stickers, and even live actors planted in real space”. The storyscape medium, and the definitions advanced, does not define an ARG as a storyscape. This exclusion is consistent with the PGA and early Jenkins model. Embracing these distinctions, a defined model, and medium will narrow the scope of this research and diminish the variables that must be considered when testing the gestalts against a design project.

The model Jenkins proposes contains explicit examples and additional requirements. It thus defines the medium for study. It is circumscribed by limiting prohibitions. Since each medium must stand alone and add, it also precludes adaptations or remakes. It must have the additive quality of each element and, therefore, an ARG is not this model. The storyscape offers a better, nameable model for the study of story design and vocabulary.

The ARG model is better categorized as a game medium and as such may not support a full narrative experience without a form of “additive comprehension.” Ryan (2012, 14) also concurs, “ARGs however are not simply forms of storytelling, they are primarily games, which means that they are played for the sake of problem-solving much more than for the intrinsic interest of their narrative content.” ARGs are an example of the diversity of opinion about what constitutes a transmedia story, and the confusion

when aesthetic principles such as Dena's and Jenkins's clash. That is why my theory leverages the transmedia franchise model to define and name a medium.

Distinctions that are part of the definition of a storyscape, and distinguish it from other transmedia works, are:

1. Stand-alone elements building to a larger whole. (Jenkins and PGA)
2. Adaptations are not allowed. (Jenkins and PGA)
3. There are at least three distinct media artifacts. (PGA)

Moving forward to understand this medium, there are other useful principles and specific affordances that are also helpful to define this medium, even if they fail to distinguish it from other transmedia work. Nonetheless, critical approaches across the field of transmedia can be consolidated to analyze Jenkins's framework, and subsequently the storyscape. The following approaches, methods, theories, affordances, and qualities are filtered by their relevance to the storyscape and this model and the research questions of this thesis.

## **2.4 Topics in Transmedia Storytelling**

This section reviews significant topics in the field of transmedia storytelling relevant to the storyscape. Jenkins has called them principles. These topics, as presented, can combine models, approaches, methods, practice, and other qualities that are significant ways to understand or design transmedia storytelling. Since the authors of these topics are not bound by the definitions above, they have perspectives that are useful for developing a storyscape design process but are modified to fit to the narrower definition of this medium. They are organized so as to consider the primary scholarly contributions to the transmedia storytelling field, highlight relevant design concepts and

methods, and elaborate significant considerations and vocabulary for creating a storyscape. These topics blend analysis and design methods and encompass similar qualities.

By topics, I am referring to models and terms directed toward understanding the corpus of transmedia storytelling work and also significant qualities that may affect or differentiate the field from other media. Overall, I do not characterize these topics as design principles, although they are intrinsic to the process of designing or authoring a storyscape. Jenkins (2009b) defined seven “principles” of good design. Marc Ruppel (2012) examines multiple approaches to transmedia storytelling including intertextual, paratextual, narratological, commodity, principles of operation, and medium-centric. These are further conflated with methods and aesthetics in some discussions. In this section, I group these topics for similarity and relevance to storyscape design, with the aim of consolidating approaches, methods, and aesthetics as design topics and considerations. The storyscape is a medium-specific approach, though as I noted, it is a medium of media, and also story-centric, similar to the narratological approaches that I reference.

The topics selected loom large in transmedia discussions, both in theory and practice. Some topics attempt to explain transmedia based on a frame or method. Other narrative approaches are useful to digital literary scholarship for close readings. However, the storyscape medium and a story-based design approach contextualize further design investigation and practice through integrating these principles into the design process. Affordances are reviewed in the following section and become active design considerations later in the dissertation. Affordances are the actionable part of a medium

creating interaction or negotiation between authors and audience. The main topics or principles I have culled from the literature of transmedia storytelling that are relevant to this thesis include storyworlds, closure, spreadability, collaborative authorship, and synergy. They also provide a background to my story-centric approach and to the embodied affordances that are treated subsequently as practical design elements.

#### **2.4.1 World-Building, World-Making, and Storyworlds**

One of the most common critical approaches to transmedia storytelling is to examine the frame provided by the fictional world often called world-building or storyworlds. It is invoked as narrative model (Ryan 2013), a non-narrative model (Klastrup and Tosca 2004), and a method (Long 2007; Dena 2009; Jenkins 2009b). Jenkins, in particular, uses world-building in his early writing though later starts to discuss storyworlds. Storyworld has recently entered Ryan's lexicon and is often employed by other media or transmedia scholars casually or explicitly to describe different aspects of a shared story space or shared geography of stories told across media.

This muddle of words and concepts—often ill-defined regarding storyworlds—is also distinctly different from Mark Wolf's (2013) work analyzing the features of "imaginary worlds." His focus, which parallels the work in this dissertation, describes the subcreation of imaginary worlds that are not related to the "real" world. His approach is compatible with mine in that it is not a design process but a framework for categorizing and understanding a subset of fictional worlds. It organizes the breadth of imaginary worlds across media, but not specific to transmedia (Wolf 2013). It also develops a dividing line between real and imaginary worlds. This contrasts the work of many transmedia storytelling theorists including Ryan, Jenkins, Mittell, and Dena, who look for

storyworld principles that may apply across all fiction or nonfiction stories simultaneously. Unlike storyscapes, most storyworld and world-building approaches do not make the distinction between imaginary and “real” worlds.

It is difficult to ignore the topic of storyworlds or world-building in transmedia storytelling because it is central to the field and often discussed. It also crops up because the artistic process is neither linear nor logical and proceeds from multiple inspirations that may be sparked by the imagined ideas, people, feelings, or sensory world of an author. The nature of the gestalts I propose point to any possible imaginative scheme as an origin for a powerful story. Certainly storytellers create narratives that take place in an evocative time and place with overlapping characters and stories. The creative process exists as a narrative mode (Bruner 1987) or as a gestalt that can be prompted by thinking about the setting, visual tableau, or epic vision, and then proceed to the story from the spark of that inspiration.

There is no one formula for authoring a story, although plot and character have been considered dominant since Aristotle. Writers start with ideas, themes, or even an image for stories, as was the case for Faulkner’s most famous novel. Faulkner (1957) explains, “*The Sound and the Fury* came out of an anecdote, a picture of a—a little girl, the muddy seat of her drawers when she climbed the tree to look in a parlor window, and that’s—the book came from that.” He also notes, “no one can say just what method the story demands. Apparently there’s something inside the man or the woman that must be—be told, must be written. It could be an anecdote. It could be a character. It could be an idea, but I don’t think you could say which system to—or which pattern to assume in order to—to create a story or a book” (Faulkner 1957). Understanding the dynamic of

this creation means that I can't completely reject storyworlds as a creative approach for some authors, given the diversity of inspiration and blurring of the line between ideation and execution. Nonetheless, as I explain below, there are reasons why this approach constitutes a poor analytical tool and weak design method and is inadequate as a unifying design principle.

The idea that Hollywood has progressed from pitches about stories, to pitches about characters, and finally to pitching whole worlds is overblown and unsubstantiated. Too much has been made of a quote by Henry Jenkins (2009a) in support of the world-building method: "In *Convergence Culture*, I quoted an unnamed screenwriter who discussed how Hollywood's priorities had shifted in the course of his career: 'When I first started you would pitch a story because without a good story, you didn't really have a film. Later, once sequels started to take off, you pitched a character because a good character could support multiple stories and now, you pitch a world because a world can support multiple characters and multiple stories across multiple media.'" This anecdote is scant evidence to infer such a substantial shift in storytelling from plot and character to world. There is a stronger argument for seeing the continuing unifying structures of character and plot (Aristotle 1998) in Aristotelian models as well as meta-structures identified through the narrative investigation of story by Ryan (2012) than for reorganizing a new narrative approach based on world-building. Just because a writer characterizes a pitch as a storyworld doesn't mean that is the germ of the story or has any relevance to designing a story across media. It is just another Hollywood anecdote that is more misdirection than clarification of a new model of storytelling.

These arbitrary characterizations by entertainment people, often in a public relations context, with no compulsion to portray the design process accurately, are taken as gospel by academics. Key examples of transmedia franchises such as *Star Wars*, *Lost*, and *The Matrix* were conceived of as stories in a way that followed traditional writing approaches: teasing out a storyline or character while achieving a whole that “told a story.” This is not to say that we can simply adopt a traditional Aristotelian model to define the creative process in storyscapes, but the storyworld approaches suffer from the problems outlined here. Jenkins (2007b) often attests to the relevance of the storyworld or “complex fictional worlds” and the activity of world-building, but that focus is more about a consistent canon or the elements within a mythology that I break out in chapter 3. It is evident that the world of these stand-alone story artifacts is shared, and that further “extensions,” or other artifacts, must have a relationship to the physical story manifestation of the world. However, the primacy and relevance of a world-building method to building a resonant storyscape model is not well substantiated academically, or in practice.

World-building as a practice (from Jenkins), storyworlds from academia (Ryan), universes from franchises (Long), and transmedia worlds (Klastrup) as a general concept create imprecision in both vocabulary and design approach. Across scholars and artists, the definition and practice of these words are blurred and indistinct. In addition, central to this thesis, they often contain character, story, and mythology that distort concepts central to dramatic structure in the service of a hodge-podge that fails to clarify either an analytical approach or a design method.

My approach marginalizes world-building and storyworld models as ineffective overall and an inaccurate research model for the storyscape. World-building, as a method or principle of a storyscape, is too broad and includes too many substantial elements, such as story and character, and even canon. The storyworld models in academia often fail to distinguish between an imaginary world and a world in a fictional story. In storyscapes, that is significant since they are distinguished by their imaginary worlds. Thus storyworlds and world-building do not figure into my design approach. However, recognizing its centrality to the discussion of transmedia storytelling is important because the creative and academic communities have found it a helpful conceptual principal for conceiving a whole transmedia story.

The critical question for storyscape design is whether this topic can describe the workings and construction of stories across media in a way that combines theory and practice or whether they disconnect theory and practice, instead, only illustrating academic models that provide simple narratological constructs or critical viewpoints. Ryan (2012, 2) points out succinctly, “This notion of storyworld is central to the phenomenon of transmedial storytelling, since it is what holds together the various texts of the system. The ability to create a world, or more precisely, the ability to inspire the mental representation of a world, is the primary condition for a text to be considered a narrative. This leads to the question: what is a world?”

Ryan highlights key constructs associated with storyworlds. First, the shared constructs in these worlds act as a linking mechanism to order these narrative experiences in our memory but it “holds together” through other models than a shared geography. Indeed, Ryan (2012, 3) points out, storyworlds are a “concept that makes a lot of intuitive



sense, but it is very difficult to define in a theoretically rigorous way.” Indeed, this illustrates the precise confusion I note above.

The confusion of what is a storyworld, and how you define it, becomes far too diffuse. As noted earlier, the storyscape is an imaginary world, but in the storyworld approach this quickly becomes a conundrum in applying the concept to all narrative that has transcended a single medium. Is the real world a storyworld? Stories have always had settings, and as Murray (1998) explained, there is a potential pleasure in immersing ourselves in beloved settings that refer to stories that have resonated with a reader, but that does not mean the setting has somehow become central to storytelling.

This is not to say that storyworlds are not worthy of consideration, but they need to be placed in the context of a more fruitful model. Geoffrey Long (2007) notes, “Taking the time at the outset to set down the rules, histories, and general character of the world in which each of these extensions is set goes a long way toward maintaining a sense of consistency across the franchise.” In the language of practice and the analysis of this project, these story elements are immanent within the story, such as in the *Lord of the Rings* book trilogy, or can be placed more accurately in the practice of creating the four gestalts, starting with myth-making, for these larger franchises. It is important to note that in practice, Long’s storyworld elements may not be part of the diegetic space of the story, and therefore not acknowledged by an authorial group as canonical. Nonetheless, there is an overlap of story parts, gestalts, and conceptual models and canon is often considered part of the storyworld model. This also complicates the attempt to find some design clarity using the storyworld approach—it contains too many elements. The storyworld approach sometimes contains narrative, but it is not narrative. The world may contain

story, character, arcs, conflicts, and more that are covered in a storyscape mythology—but but the storyworld is not fundamentally narrative. Long emphasizes this world-building consistency, as canon, which works as a linking concept across artifacts and provides aesthetic improvement through consistency. For Long, much of world-building is about creating a consistent canon and thus is more useful to understand how canon can work across the spectrum of storyscape design instead of seeing world-building as essentially a consolidation of canon. The complexity of canon in *Star Wars* and *The Marvel Universe* undermines coherent storyworlds

World-building is Long's (2007) second aesthetic of transmedia storytelling, and "the world must be considered a primary character of its own, because *many transmedia narratives aren't the story of one character at all, but the story of a world* (his emphasis)." Perhaps this is where the confusion originates, in that stories can have locations as a character, such as in Woody Allen's *Manhattan*, and this may be true of some storyscapes, but not all. Further, if the world is a character then in that case it is better situated in a character-centered model of stories.

Janet Murray connects world-building to the "encyclopedic" quality of digital media and Jenkins applies that affordance to transmedia storytelling as the need "of audiences to map and master as much as they can know about such universes, often through the production of charts, maps, and concordances" (Jenkins 2009a). Murray is correct in situating this aspect of the world in the pleasure derived from the discovery of knowledge about an exotic or unusual place. Storyworlds work best in transmedia stories that create imaginary worlds with supernatural laws and imagined ecosystems. Ryan investigates ways to apply storyworlds to all fiction, transmedia in particular, but when

faced with the variety of different ways in which contemporary fiction represents the world, the concept recedes into an abstraction that has limited design value. On the other hand, designing for the pleasures and affordances expressed through the computer's capacity is a more consistent design approach across media.

One could say that the storyworld is intimately related to the narrative—after all, how could it not be in the integrated process of creation? However, that is an approach, or method, that should be deemphasized because it puts story and character in a secondary position. The basic narrative structure of *Romeo and Juliet* transcends the various times, places, cultures in which it is set and works across diverse storytelling media. From the musical *West Side Story* to Baz Luhrmann's modern *Romeo + Juliet*, or even *Titanic* pitched by James Cameron as “Romeo & Juliet on a ship,” the story premise remains. The central conflict of romantic love against family loyalty embodied in these characters is a central engine that works across the many rich worlds that the play has been staged. It is the type of world or setting, often an imaginary world, that most contributes to the confusion of the storyworld approach.

Storyscapes are mythic stories, concerning supernatural or super-scientific powers that are set in imaginary worlds. These imaginary worlds have given rise to viewing the elaborate settings and rules of these supernatural realms as primary story design principles across media. This is how world-building became seen as a central principle. It emphasized the production design over the central story, a mythology, as I explain further in Chapter 3. Storyscapes can express a diversity of stories from adventure, or character, or social equality but are often constrained by their genre or the imaginary nature of the worlds. Storyscapes, as defined herein, can easily be imagined because they are fantastic

worlds of time and space, distinct from contemporary drama that finds a corollary in, or depicts a view of, the real world. Readers had imagined Tolkien's vivid fairy worlds of *The Lord of the Rings* before CGI made flesh of Hobbits and Elves.

For a storyscape, because of the setting in an imaginary world, a world-building method incorrectly positions production design as pre-eminent. "As the art of worldmaking becomes more advanced, art direction takes on a more central role in the conception of franchises," Jenkins (2006a, 116) asserts erroneously. In public relations, production design in imaginary worlds can be reified in very pleasurable photos, easily distributed, that often connect to other cultural artifacts related to the franchise. However, the centrality of art direction has not been supported in the eight years since he wrote this. For example, art direction is peripheral for stories set in the contemporary world or for nonfiction documentary transmedia.

Imagining storyworlds or world-building as an organizing principle for stories set in a modern real-world scenario or nonfiction documentary transmedia pieces illustrate that art direction is peripheral in these texts. Boni (2013), in his discussion of *Romanzo Criminale*, is more concerned with the mythic dimensions of the world, since it is situated in the real world and references a contemporary crime genre. In other transmedia, as with plays and movies, art direction is important, but not central, to creating a storytelling model. The fantasy nature of most examples of a storyscape confuses this issue with a blizzard of fantastic animals and futuristic devices but, to paraphrase, these observers can't see the story/forest for the props/trees. Geoffrey Long uses an explanatory quote from science fiction author M. John Harrison to criticize, and question, his emphasis on storyworlds as an essential element in the aesthetics of storytelling. I agree with Harrison:

Worldbuilding is dull. Worldbuilding literalizes the urge to invent. Worldbuilding gives an unnecessary permission for acts of writing (indeed, for acts of reading). Worldbuilding numbs the reader's ability to fulfill their part of the bargain, because it believes that it has to do everything around here if anything is going to get done. Above all, worldbuilding is not technically necessary. It is the great clomping foot of nerdism. It is the attempt to exhaustively survey a place that isn't there. A good writer would never try to do that, even with a place that is there. (Quoted in Long 2007)

There is little to add to this litany of a storyteller's frustration with a story model focused on pleasures of the details and the ability to explore those encyclopedic details through new affordances, thereby usurping the meaning creation of conflict, catharsis, and character. *World-building* and *storyworlds* are helpful terms in discussing transmedia stories inasmuch as they aggregate the mythology, art direction, characters, and geography of the setting, but moving forward in this work, the properties ascribed to storyworlds will be situated more accurately within story aspects such as mythopoeia or canon, and design affordances such as encyclopedic or participatory.

#### **2.4.2 Closure**

Closure, as an element of the structure of stories, is a central topic in discussion of the design of transmedia stories. This is because it is a narrative feature that operates uniquely in the storyscape medium. I have noted previously Aristotle's demand that a story should have a clear and satisfying ending producing catharsis. As interactivity and narrative in games have increased, with overlapping stories, the discussion of transmedia story connections and intertextual references that tell a closed story has become a design

concern. This is because closure drives the dramatic structure that generates catharsis. Brenda Laurel (1991) models her approach on Aristotle's poetics and a remediation of that theatrical rhythm into the new digital converged medium. Michael Mateas built games such as *Façade* to recreate that emotional catharsis and dramatic interaction, by creating beats within a classical Aristotelian-based Freytag pyramid of rising, cresting, and falling action (Mateas 1998; Mateas and Stern 2006). For Laurel and Mateas, the interactivity of the computer medium challenged how closure worked. In transmedia storytelling and the storyscape medium, a lack of closure combined with media that contains few story elements threatens that narrative clarity and the catharsis. *Lost* is a good example of how the diversity of experience frustrated a final clarity and catharsis in its conclusion. The fans were confounded and upset as multiple expectations converged in a few final episodes and transmedia coda.

Storyscapes are made up of stand-alone artifacts; these dramatic models can occur, and resolve with closure, within the context of each medium of the storyscape. However, the larger whole functions without closure, and this is a substantive change to viewing and designing this medium of story. Closure changes in a storyscape, and that becomes a design consideration and a part of our vocabulary as methods for creating extensions and continuations of the story occur. Transmedia stories function as "open works," as explained by Umberto Eco (1989, 16) in the chapter "Poetics of the Open Work." In describing an emerging poetics, that the storyscape exemplifies, he points out, "The two-value truth logic which follows the classical aut-aut, the disjunctive dilemma between true and false, a fact and its contradictory, is no longer the only instrument of philosophical experiment. Multivalued logics are now gaining currency, and these are

quite capable of incorporating indeterminacy as a valid stepping-stone in the cognitive process. In this general intellectual atmosphere, the poetics of the open work is peculiarly relevant: it posits the work of art stripped of necessary and foreseeable conclusions.”

The “open work” aesthetic becomes a significant design consideration in two ways: story closure and canon. Story closure can change the understanding of the story by adding different stories that present alternate points of view, facts, or facets to a story. In one gestalt visual example below, multistability, you can see either the face or the vase. A storyscape can contain this set of multiple interpretations on purpose, acting additively to enhance the story. An open work can lead the viewer to different

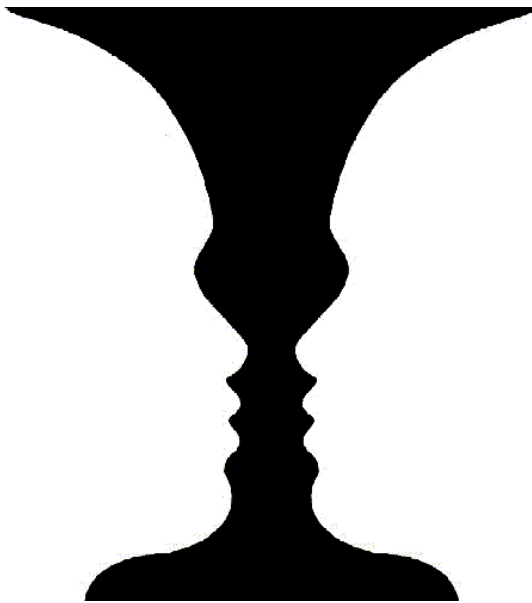

**Figure 6 Gestalt example of multistability.**

conclusions or interpretations of events, or even a new catharsis. This aesthetic encourages new ways to negotiate meaning and adds to the pleasures of the storyscape medium. Jenkins (2007b) points out that in transmedia storytelling, “We are drawn to

master what can be known about a world which always expands beyond our grasp. This is a very different pleasure than we associate with the closure found in most classically constructed narratives, where we expect to leave the theatre knowing everything that is required to make sense of a particular story.”

Eco (1989) breaks down this process in his discussion of the Aristotelian nature of television aesthetics and suggests how an open system of transmedia both extends and focuses the story. Discussing Aristotle and the unity of plot, he indicates, “Likewise, within a certain field of events, there can be some that, although they have absolutely no connection with one another, intersect and overlap, creating a number of situations that will evolve in different directions. Or a certain group of facts, which, considered from a particular angle, seem to evolve toward a certain resolution, may, when considered from a different angle, proceed in a completely new direction” (Eco 1989, 110). This view offers new narrative structures for the storyscape. Eco (Eco 1989, 110) also underlines significantly, “On the other hand, this does not change the fact that we need to look at them from a unifying perspective,” which in this medium are the four unifying gestalts. And further, he goes on to say, “we need to group them in a specific form. In yet other words, we need to unify them into experiences.” The grouping is the storyscape and becomes a unifying set of experiences. This understanding of the dual nature of the storyscape medium as working inside each closed stand-alone medium and as an open work that is an aesthetic whole becomes a dual design concern. This affects the aesthetics through a lack of full closure in any specific medium, or in the introduction of new literary pleasures as Jenkins elaborated, or in the ability to explore new causalities and vectors to stories through an open work.



Understanding the aesthetics of the open work and the topic of closure requires an appreciation of how this may impact historical dramatic structures and frames. Bordwell and Thompson's (2010) main critique of the storyscape medium focuses precisely on the issue of closure: "The special thrill of beginning and ending can be vitiated if we come to see the first shots as just continuations of the webisode, and closing images as something to be stitched to more stuff unfolding online. There's a reason that pictures have frames." It is true that this medium may severely impact the catharsis of story, even within the stand-alone structure of an individual medium. Perhaps the *Star Wars* first six films have been dramatically diminished for some viewers in the experience of their individual catharsis. The new *Star Wars: Episode VII – The Force Awakens* indicates it only a partial catharsis in the title. On the other hand, this much larger storyscape, with other engaged affordances and experiences, may increase the special thrill, or resonance of a catharsis. I agree with Bordwell and Thompson and recognize the dual aesthetics of a storyscape as an approach that embraces closure and the open work as two sides of the same coin. Each has an aesthetics invoked, and there are narrative complexities to be considered in taking away the frame of a well-ordered beginning, middle, and end. This is not a question of good or bad design, but how designing for the storyscape medium engages closure in ways that affect dramatic structure both positively and negatively. Closure for individual works must be considered, but also how the storyscape achieves closure. The *Star Wars* stand-alone works support individual closure while the franchise achieved a more general climax around each trilogy. With recent developments, *Star Wars* evolves beyond those endings, but toward the grander arc that Lucas previously laid out.

Closure and canon are interrelated. Defining the boundaries of canon is a frame and provides narrative closure. Alternately, noncanonical work, and particularly participatory and fan culture explorations, defy any frame or closure. If the work has no definite boundaries and explores divergent approaches and vectors to the story, then the open work compels the reader to consider what is included within the story and how contradictions to causal events are resolved in order to create a coherent whole of the storyscape. Canon as closure is explored further in the following discussion of canon in Chapter 3. Closure represented as canonical coherence, or lack, thereof, reflects on design considerations in fashioning the whole narrative tapestry or artifact ecosystem of the storyscape.

### **2.4.3 Collaborative Authorship**

The practice of collaborative authorship is another topic to frame an understanding of the storyscape model. Much has been made of the collaborative authorial nature of transmedia storytelling production because it engages so many different production and creative methods, as well as challenges a central authorial role in the design of a storyscape. Collaborative authorship requires multiple disciplines such as games and movies to find a way to work together or that authorial intentions must expand beyond an author's core competency. For example, the Wachowski siblings' focus on movies while including online gaming and animation in the *Matrix* storyscape forced them to give up some control, deferring to other media authors. Deferring to authorial competency in discrete media can translate into a diversity of aesthetic and narrative visions. In the example of *Star Wars*, Disney now functions as a coordinating authority through its control of the intellectual property, while *Star Trek* has a balkanized IP

controlled by different corporate entities, leaving the possibility of collaborative authorship impaired (Lang 2013). Jenkins (2007b) points out “transmedia storytelling requires a high degree of coordination across the different media sectors” and the more artifacts created, the more coordination required.

This point of view presupposes that coordination, or consistency, is a valuable aspect of a transmedia story. Geoffrey Long (2007) argues forcefully that consistency across media is most important, mostly expressed through a consistent canon. Some of the most inconsistent franchises, such as *Star Trek*, have managed to achieve a complex canon and mythology without much coordination. Although individual parts are often successful, *Star Trek* has lost coherence as a storyscape and lacks a collaborative transmedia treatment, and one reason is the lack of intellectual property coordination resulting from split property rights. Two separate entities, Paramount and CBS, have split the TV and movie rights (Leane 2015). To add insult to canonical injury, the very successful movie reboots take place in an alternate universe, as illustrated by the graphic below (Fig. 7).

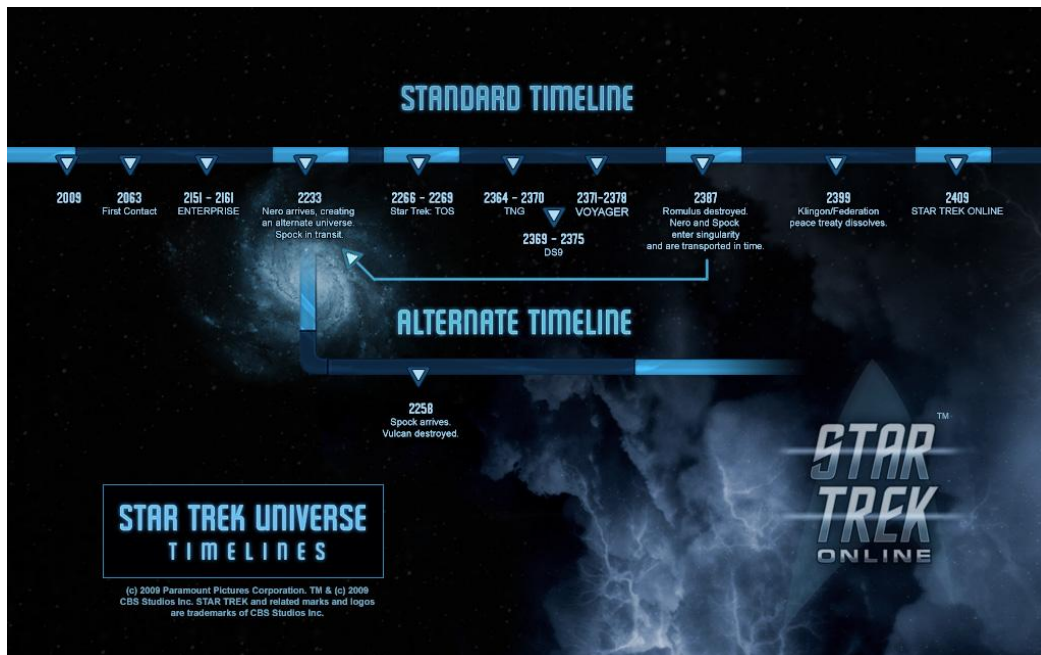

Figure 7 The new *Star Trek* timeline can accept, alter, or deny the previous canon. © 2009 Paramount Pictures.

The potential transmedia coherence of *The Marvel Universe* has also been disrupted by its licensing of characters to different movie studios. In this instance, canonical consistency and collaboration across media extensions are fundamental values of the authorial controllers—in this case, Marvel, a corporation, owner of the IP (McMillan 2015). Thus, the practical implications of collaborative authorship have design implications for the coherence of the work and also its consistency or canonical synchronization.

The *Star Trek* franchise, still considered a storyscape despite canonical and authorial obstacles, has engendered fan and journalistic criticism as the rights holders fail to exploit transmedia opportunities, or stand-alone works fail to interlock well with the larger storyscape. J.J. Abrams and his team have been frustrated in their grand ambitions to create a storyscape (Lang 2013). Nonetheless, over time, with the vision of Gene

Roddenberry still guiding the core myths, story arcs, and characters, the authors and IP holders have built a robust group of works across media, even as they erode the coherence of the whole work as a storyscape. This centers the topic of collaborative authorship in understanding the storyscape for design. It speaks to how disciplines collaborate in different media but also the logistical issues of that collaboration. It is also relevant to narrative models and coherence since the practice of that collaboration can affect the aesthetics and story of the coherent model. The four gestalts model reviewed in the subsequent chapter discusses how the whole is conceived out of an aesthetics of consistent or balkanized collaboration, and in chapter 5, the four gestalts are used to research authorial collaboration across media.

#### **2.4.4 Spreadability and Drillability**

Another central topic that can be considered both a principle (Jenkins) and a method for design is spreadability and drillability. Both are proposed as native features of transmedia storytelling and are therefore often hallmarks, a way to describe user participation, or a design affordance to be considered. From the perspective of storyscape design, they engage new pleasures of the medium, and academically they are considered as principles of this medium. Drillability and spreadability provide another frame for this medium extending beyond previous narrative boundaries and providing new engagements. Jenkins (2009b) indicates “*spreadability* referred to the capacity of the public to engage actively in the circulation of media content through social networks and in the process expand its economic value and cultural worth.” Not only a marketing consideration, this is also useful to link a community or provide ongoing social interaction for the story. *Drillability* is Jason Mittell’s (n.d.) term for the capacity of a

good transmedia narrative to be explored in increasing depth and with finer granularity of information in artifacts or fan culture. A good example is the *Star Trek* engineering books and the pleasure achieved in understanding and exploring the most mundane details of the Enterprise's construction and organization. However, this is a trap of observing the affordances of the medium and using them to frame a narrative principle that implies that those additional drillable details, or the spreadability of the storyworld artifacts, are organizing principles to understand or design the stories that are part of a storyscape. The approach is useful in looking at specific affordances and their consequences, but not as a central design consideration.

Spreadability deals with the circulation of content and in its bluntest formulation refers to the virality or sharing of links and memes within the larger social ecosystem of a transmedia story. Although Jenkins posits spreadability and drillability as opposing vectors, they are not in fact mutually exclusive and can both be employed in the broad affordances of a transmedia ecosystem. Spreadability and drillability are applicable topics to consider across a storyscape, but both are more relevant to a critical analysis of how that aspect of transmedia functions, than useful as a design guideline. Implicit in the use of social media, ARGs, or elaboration of factual details such as spaceship schematics, these qualities are already intrinsic in the design process. However, they function invisibly in the design process because they are only one quality or method among many. For example, spreadability is useful in promoting a character across media and engaging users. Creators, and often marketers, use this affordance to leverage spreadable media to the largest audience they can, but that is more a factor of advertising than an ability to create a viral artifact.

The same applies to the concept of drillability. Implementations of transmedial ecosystems create drillability intrinsically to the medium such as *Lostpedia*, a wiki-encyclopedia approach that allows users to collect and discuss the series and the transmedia aspects in a searchable and user authoritative space (“Lostpedia” 2013), or through other wikis instigated to provide ancillary information and other functions specific to that as a collateral and fan-based medium. It reflects the encyclopedic quality elaborated by Janet Murray (1998) and is derived from that affordance.

From a design standpoint, these principles are implicit in the goals for any medium that constitutes a part of the storyscape. They serve the storytelling goal of connecting the ecosystem and increasing participants, but designing for these goals is not a direct path. The question is how to make compelling spreadable content, such as a popular Twitter character. But starting from the premise that you want a spreadable character is a nonstarter since there is no consistent creative pathway to knowing what will become viral or spreadable. Storyscape creators want a very spreadable, re-tweetable character, and that approach may influence the overall artistic expression. However, from a narrative standpoint, the character’s appeal and internal motivations, and how that fits into the larger stories and the consequences of that resonance are primary to what creates spreadability.

#### **2.4.5 Synergy, Synergistic Storytelling, and Intellectual Property Exploitation**

The synergy approach is useful in describing the storyscape medium in the media economy and how that supports or changes the medium from that practical point of view. The definition of *synergy* is understood to mean the exploitation of marketing and product creation across an intellectual property to maximize profits by developing unused, valuable properties in different media while capturing the brand identity that has been created. Jenkins (2007b) observed, “Transmedia storytelling reflects the economics of media consolidation or what industry observers call ‘synergy.’” Synergy is a key economic consideration of the medium of the storyscape. It helps to explain the economic imperative that drives this medium and helps define another formal element of the medium in the context of large franchises.

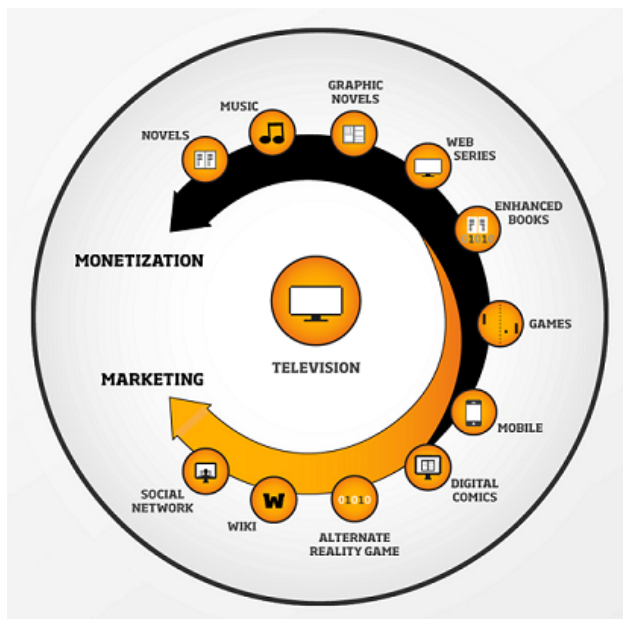

**Figure 8 Economic approach.** <http://silverstringmedia.com/news/2011/07/06/animism-zeros-2-heroes-at-transmedia-vancouver>



Many authors, and certainly transmedia entrepreneurs, examine the economic forces shaping this new medium and naturally this provides an economic imperative toward media that is profitable because of revenue or marketing. In the diagram (Fig. 8) above, the Silverstring Media blog diagram arrays various transmedia artifacts on a scale running from monetization to marketing. This may be a driving force in funding and expanding the storyscape medium, but as a design principle or unifying approach it is not relevant to this design method. This research focuses on the creative realization of a story across media. In the storyscape, a story-centric model, the economic model is not central. Synergy creates an economic impetus for the creation of a storyscape but is secondary to artistic concerns in designing a story across media for robustness, coherence, and resonance.

#### **2.4.6 Landmarks, Sync, Triangulation, and Redundancy in the Storyscape**

An additional topic I would like to contribute to storyscape design is the related concepts of landmarks, triangulation, sync, and redundancy. The phenomenological problem is we are locked inside our minds and can only perceive the world through our senses. Our view of a storyscape is what we perceive as the norm. However, we don't know whether other participants, with their personal worldview, perceive the same story and point of view. One way to establish this correspondence is with shared cultural landmarks that allow us to map our respective conceptual points of view. Stories are one example of this landmarking process and allow people to coordinate a broad range of correspondences including ideas, emotions, and worldviews by comparing their personal experiences and understanding of stories. In a storyscape, that is expressed on multiple levels from wikis and the fan websites of *Lost* to individual participants' negotiation of

texts across media—where landmarks and redundancy can result in a syncing of points of view and understanding of a whole story.

Transmedia storytelling, specifically storyscapes, offers a new broad set of virtual and physical affordances to encourage synchronization across participants. The way that stories work to sync our understanding between individuals and groups, the repetition of information in different contexts to increase comprehension, and the use of asymmetrical ways of knowing the world through discrete story artifacts all contribute to a shared understanding of a whole work. These terms complete a story ecology that includes games and space as well as other ways of knowing. Because of these qualities, when looked at as an ecology, we can see a new paradigm for meaning making that affects individuals, groups—through combined authorship and crowdsourcing—and even culture as a whole, as it develops meaning structures of creation and exposition that are an order of complexity greater than before. Landmarks, sync, triangulation, and redundancy in a storyscape and transmedia stories are another principle to be aware of in the design of a storyscape.

#### 2.4.6.1 Syncing and Landmarks

One of the main purposes of a storyscape is to sync ways of framing and understanding the story between individuals and groups. These ways of knowing the world are fluid and involve the embodied cognition of individuals and groups. Because of the subjectivity of our senses we can never be sure we are seeing and feeling the same thing as another sentient individual. A story becomes a way to coordinate our worldview. The ecology of the storyscape encompasses many different ways of knowing across media. Among those ways are logic (logos, language and symbolic logic, the plot, theme,

ideas), emotion (pathos, the emotional logic), and spatio-temporal perception (time and space as story expressed through sense memory).

Each of these ways of knowing the world through a storyscape works synergistically and additively to form a whole understanding of that story and allows us to hold apparent contradictions in a matrix of understanding. A mythic conflict in a story could be the trying to sort out the story logic that juxtaposes the choice between love and duty, as when Juliet must chose between Romeo and her family. Now when we read or view *Romeo and Juliet* as a movie, play, or book we can speak to another individual and compare our subjective experience logically or emotionally to determine if there is a shared coherence, point of view, and agreement. The compared sense/memory of the experience also contrasts our subjective experiences to find a shared view. If there is agreement with another individual on the play's logical model of the world, its emotional logic, and the aesthetic experience of our senses, then tunneling deeper into those agreements and perceptions is possible.

This allows two observations. The first is that one person validates another viewer as perceiving the same story. Janet Murray (1998) calls this the “collective creation of belief.” Because we approach the story with our own unreliable senses and then distort that view to fit our personal model of behavior (with a lot of recoloring, shading, and filling in to give it pleasing appearance for us), a viewer can never be sure that they view the story the same way as another person. Nonetheless, much agreement can be created through an agreement that comes from a shared understanding of the story, and by inference our worldview and experiences.

The second observation is that a shared landmark can be used to sync our points of view about causality, meaning, and expectations. Significant mythic oppositions expressed across the storyscape, events, characters, roles, and icons provide landmarks to become part of the participatory exchange across a storyscape. In a storyscape, this syncing process works across the media to establish coherence. Syncing gives rise to landmarks that are used across the storyscape.

#### 2.4.6.2 Redundancy, Triangulation, and Asymmetry

Redundancy, triangulation, and asymmetry contribute to this participatory and conceptual method of designing a storyscape. Redundancy of elements enhances a storyscape in two ways. One is that because not all artifacts are engaged by participants, the information for significant story landmarks is more likely to permeate the audience. Second is that redundancy can allow an individual to compare different media experiences so as to complete a deeper understanding. It is a stereo effect where two media may create a metaphorically three-dimensional object where a medium may only present a two-dimensional view. A metaphor is seeing. Cover one eye and the world is flat and two-dimensional; however when we offset that with another view we gain depth perception. A storyscape can cover many views and create a meaning that is perceived from different points of view and physical affordances. This triangulation provides a richer object for the individual and also multiple angles to compare with other observers.

Extending the concept of a stereo view across media leads to triangulation. It is a way stories convey and establish meaning within a community and for an individual. Within the individual, there are at least two views that are brought to bear—reason and emotion. These two aspects are contrasted by a third point of view—the body of

knowledge and experience that another viewer brings to the table. Thus by triangulating between different individual views and media, a more precise description of a landmark can be conceived, communicated, and shared. Further, the asymmetrical relationship between viewers and media invites an active investigation by participants in resolving those discrete views. The asymmetrical relationship unifies our vision into a coherent whole with depth and implications of a model that extends far beyond our two-dimensional perception.

Storyscape design can benefit from landmarks embedded across media in the form of the four gestalts. Redundancy can be an advantage for the storyscape because participants have different pleasures and do not engage in all media. Sync and triangulation work for both individual and community as a way to negotiate consistent meaning and coherence across a storyscape. Adding asymmetry of information and media to sync and triangulation allows a storyscape to provide a richer, more complete, model for viewers and the participatory audience.

#### **2.4.7 Topics Summary**

The topics mentioned above—storyworlds, closure, collaborative authorship, drillability and spreadability, synergy, and landmarks—are useful as academic perspectives to evaluate or model qualities of the medium of the storyscape, and as they are applied to the broader field of transmedia storytelling. However, they are less useful in organizing a unified vocabulary that can unite theory and practice around creating a single work. These topics form a foundation for understanding and analyzing transmedia storytelling and storyscapes but operate as individual models instead of an ecosystem of story. An awareness of these topics informs the design process and vocabulary employed.

Overall, these are not actionable, and the larger goal is to identify the tangible affordances within these topics and apply them to the design dialog. The next step, then, is to examine those affordances that most relevant to storyscape creation.

## **2.5 Affordances of the Storyscape Model of Transmedia Storytelling**

A transmedia story is not exclusive to the digital medium. Ryan (2013) proposes the medieval Catholic Church as an example of transmedia storytelling. It existed across architecture, painting, song, and liturgy for a largely illiterate audience. As shown in the earlier Disney diagram (see Fig. 3), contemporary precursors of multimedia storytelling forms exist. However, a storyscape is enabled by the affordances that are created through technological advances that are digital, but also experiential and performative in ways enabled by new media. Social media or other digital instantiations provide new story affordances, creating narrative and non-narrative possibilities. Listing the most significant affordances previously identified by transmedia theorists and considering their relevance for the storyscape design vocabulary is the subject of this section. These affordances include collective intelligence, additive comprehension, performance, and foundational affordances such as encyclopedic or procedural. The affordances in this section have been deemed principles, approaches, methods, qualities, and affordances. The grouping that follows is based on deriving a set of affordances to be considered as part of the storyscape design method and model. They are a companion to the four gestalts but are not story-centric, or do not necessarily contribute to a single work. They are useful affordances that are of high value and relevance to the storyscape.

### **2.5.1 Collective Intelligence, Crowdsourcing, and User Participation in Groups**

Transmedia storytelling is the ideal aesthetic form for an era of collective intelligence.

—Jenkins, “Transmedia Storytelling 101”

Lévy (1997) has identified collective intelligence as a new form of readership that can be applied to transmedia artifacts, which in turn has important implications for the aesthetics of storyscape design. Collective intelligence constitutes a powerful affordance in various submedia, a term I am using to describe a medium such as an alternate reality game that stands alone within the larger storyscape medium. Frank Rose (2012) explains how Nine Inch Nails in their promotional effort *Year Zero*, an alternate reality game, specifically dropped cues in the form of encoded thumb drives at concerts with the intention that the fan base would find, upload, decode, and follow up on the messages contained within. He linked this process to the use of collective intelligence to move the narrative forward. *Lost* included maps in its television shows that required users to upload and decode them to get narrative cues to further episodes and other media (I. Askwith et al. 2007).

Collective participation becomes a guiding principal to designing a transmedia story because audiences, collectively, can “stitch together a coherent picture from the dispersed information” (Jenkins 2007b). My story model differs somewhat: Jenkins speaks to a larger plot structure that may be revealed, whereas in franchises such as *Star Trek* that have no overarching, coherent storyline or canon there is often effective transmedia stitching by audience participation in noncanonical outlets such as comic conventions and fan fiction. Jenkins (2007b) succinctly points out that: “Participants pool information and tap each other’s expertise as they work together to solve problems. . . . Transmedia narratives also function as textual activators—setting into motion the production, assessment, and archiving information. . . . Consumers become hunters and

gatherers moving back across the various narratives trying to stitch together a coherent picture from the dispersed information.”

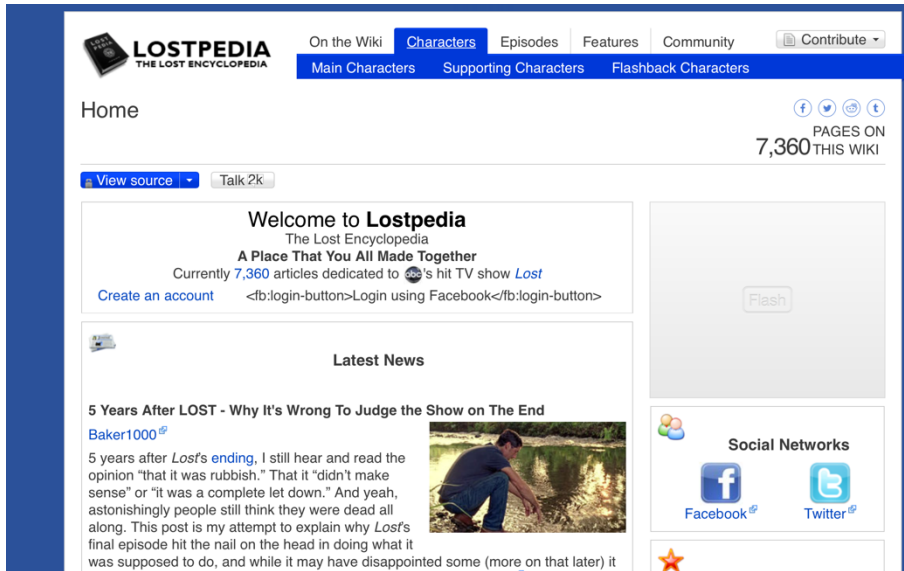

**Figure 9** Lostpedia. Audience collaboration at work.

This form of collective participation is a design affordance in the interactive media that is part of a storyscape. The storyscape can be considered a puzzle that needs multiple people to be solved (through collective intelligence or crowdsourcing) or as a form of engagement that requires user participation in the unfolding of the storyscape. Further, this story ecosystem has evolved to create a collaborative user ecosystem in the form of wikis such as *Lostpedia* (“Lostpedia” 2013) (see Fig. 9) or *Wookieepedia*. In the case of the *Lost* storyscape, this ecosystem results in a many fan sites attempting to unravel the puzzles offered by the show and work out the science or causality of the story and characters, while others focused on “shipping,” campaigning for one romantic relation or another. It is also important to note that with the affordance come limits.



Collective intelligence requires enough participants to crack often difficult tasks. The storyscape must be large and well promoted in order to leverage this affordance.

### **2.5.2 Additive Comprehension**

Game designer Neil Young coined the term, “additive comprehension,” to refer to the ways that each new texts adds a new piece of information which forces us to revise our understanding of the fiction as a whole.

— Jenkins, “Transmedia Storytelling 101”

The additive comprehension principle allows for a storyscape design with levels of story, plot, or character knowledge existing outside of the individual submedium but adding up to a new understanding, or dramatic arc and payoff. The additive method may locate a plot point in one medium that provides a different motivation to a character in the primary medium to change our perspective and reshape our model of the whole story. Like the example of multistability in closure—additive comprehension can reshape our perception. Additive plot points can create greater depth in the realization of a different interpretation of events or a catharsis of the narrative in a submedium that may not possess much character or plot. Further, the additive comprehension quality allows an aggregation of texts and experiences that may be consumed as a subset of the whole of the storyscape. Some participants will choose the media that is of interest to them and ignore others. Nonetheless, the design creates an additive quality through the layering of additional storyscape information, whether narrative, mythological, or otherwise.

For many commentators, additive comprehension is a quality well expressed in the *Matrix* storyscape. *The Matrix* built its story across media requiring an active participation in the many media products to realize a full understanding of the storyscape and the plot distributed across media. Brenda Laurel (1991) suggests in her discussion of interactive narrative that interactive readers are required to work and participate to

engage a story. That effort may deter more passive readers. Jenkins (2006a) addresses the “work” requirement to put a transmedia story together in his original essay on *The Matrix* and how some audiences may see this as too high a bar, or feel excluded by not consuming the complete set. Murray (2011) also attacks this affordance as being untenable by demanding too much of an audience: “Additive design is not stable because it takes too high a cognitive load: if you don’t believe me, try to figure out which game events belong to the canonical *Lost* universe, or what to make of the characters in the *Lost* video game that look enough like the characters in the TV series to make it annoying that they are not played by the original actors.” A storyscape may require a demanding cognitive load to comprehend plot and causality spread across media if the audience feels they must work hard to understand the full story or the individual stand-alone parts are unsatisfying. On the other hand, if the parts are stand-alone and offer rich media pleasures in isolation than this affordance scales to different participants. For some viewers, *Star Wars* is just the movies, but for others it is a complex universe, with a deep backstory expressed in books, fan sites, and cosplay, that adds to their comprehension of the movies and games.

This additive comprehension affordance can be used to enhance and deepen plot or character at the cost of additional effort on the part of the participant. However, even a loose confederation of additive artifacts—games, stories, rides, merchandise—create a greater comprehension in viewers as they negotiate their own model of the story and pleasures across the storyscape medium. In my approach, it is important to understand that the four gestalts, mythopoeia, character, canon, and genre, are additive across the whole storyscape, whether or not the participants are investigating a story plot extending

across media. Additive comprehension, in this formulation, can function beyond the causality of the plot. While some forms impose a cognitive load or there is audience work involved, additive comprehension is a unique and exploitable affordance for this medium. If additive comprehension is conceived as a scalable engagement with story across media, to suit each participant's unique sensibilities, then it is an affordance to be exploited even though individual readers may elect to not participate.

### **2.5.3 Participatory, Paratexts, and Role-Playing Affordances**

A transmedia text does not simply disperse information: it provides a set of roles and goals which readers can assume as they enact aspects of the story through their everyday life.

—Jenkins, “Transmedia Storytelling 101”

A quality of a storyscape is creating character roles to be enacted or providing performative game-playing opportunities using diverse media. As Jenkins points out in the above quote, some of the participatory qualities of enacting roles can be exploited with transmedia storytelling as it enters everyday life. *Lost*'s alternate reality games (I. Askwith et al. 2007) provided opportunities to be a part of the show such as this example from *Lostpedia* documenting a *Lost* panel event at the San Diego Comic-Con: “Rachel Blake from The Lost Experience made an appearance ‘in character’ and accused the writers of being liars; she then introduced HansoExposed.com. Her outburst can be seen on YouTube. Also, glyphs were found on bracelets of panel members Garcia, Kim, and Lindelof.” These panels and her appearance integrated the verisimilitude of the *Lost* experience into fans' everyday life. Experiences like the “Diagon Alley” opening in *The Wizarding World of Harry Potter* in Orlando provide first-person engagement with Harry Potter stories (Lønberg and Rasmussen 2011). In digital media, Janet Murray (2011) has emphasized the participatory quality as a key affordance available to digital media. Since

a storyscape is a digital medium, a medium of media, this participatory affordance is the umbrella under which I group other transmedia topics such as paratexts, fan participation, and role-playing. Different scholars have explored each of these topics in detail, and this net may be too diverse for some, but the goal is to look at the participatory affordance that is leveraged as part of an overall design method of a storyscape.

Role-playing is an affordance that can be expressed in two parts. First is the directly performative aspect that can be encountered in a live-action role-playing game (LARP) connected to a transmedia story or in flavors of an alternate reality game. The *Welcome to Sanditon* (Bushman and Dunlap 2015) extension of the Jane Austen-based video blog *Lizzie Bennet Diaries* (Green and Su 2015) extends into fictional character creation and participation. Participants joined an online community, created characters, and engaged with a prearranged and evolving story. Even costume role-playing was supported. The role-playing by the participant/reader as a character in Jenkins's transmedia story model is an important element in creating a first-person embodied story experience. This occurs in the first-person theme park example *The Wizarding World of Harry Potter*, and the third-person immersive interaction with the story, such as the *Lost ARG*. This participatory quality engages with the transmedia aesthetic of story reality that the user can inhabit. Storyscapes and transmedia storytelling blur the line between where the fictional story ends and the real world begins as they extend through media and encourage participatory affordances.

Verisimilitude, a transmedia and storyscape aesthetic, as Christy Dena (2009) refers to it, is discussed subsequently but is bound up in the participatory affordances of the storyscape. This aesthetic, manifested in role-playing or participation, is implemented

as users enter a diegetic story space overlapping the real world illustrated by the *Lost* example of Rachel Blake exposing a conspiracy at a Comic-Con panel. This experience connected the hard-core fans present to observe the panel, with some ARG participants, to the panel members' participation and exposure with glyph-covered bands, and extended out in a web across the ecosystem of *Lost* to connect these participatory implementations. Story participants are often desirous of exposing themselves to embodied interactions, and this is a useful affordance to express other ways of knowing the story. The role-playing affordance also feeds into additive comprehension by adding to an accumulated experience or perception of an overall work.

The second form of participation the transmedia community references is not a form of re-enactment or first-person fiction but is engagement in activities that require a participatory community for collaboration and problem solving. This participatory quality is parallel to the discussion about collective intelligence but is framed from the individual participation instead of the group dynamic as a whole. This can be collocated under the concept of collective intelligence and participatory media since a storyscape can scale from individual to group participation. Platforms on the web and social media, whether created by central authorial authorities or fans, create new and varied forms of participation that can range from commenting, collecting, and problem-solving, to fan fiction and more. As a design approach, participation or role-playing is a productive affordance in the diversity of ways it can be employed across media artifacts. This participatory affordance is often broadly designed and considered a scalable quality in implementation. For example ARGs support a diverse level of role-playing, participation, and imagination depending on the participant's inclination, which Christy Dena (2008)

calls “tiered participation” and that is expressed in analyses of ARGs such as *Conspiracy for Good* (Stenros et al. 2011). It is conceivable that these affordances could grow into a full-scale level of performance such as a LARP or the Holodeck narratives of *Star Trek* reimagined by Janet Murray as participatory narrative spaces. Currently, this participation is limited to first-person experiences such as rides, ARGs, some personal character development through participatory game playing, and forms of personal engagement that extend the story into personal space or imaginative play through narrative games connected to a storyscape such as the *Star Wars* franchise. Role-playing and participatory affordances extend into paratexts, merchandise, and other objects that allow an extension of the individual’s participation into an enacted story or connection that extends beyond the canonical storyscape into the experience and story conception of the participant. This can be dressing up as Darth Vader at a Comic convention.

Paratexts are defined in Jonathon Gray’s (2010) *Show Sold Separately: Promos, Spoilers, and Other Media Paratexts* as participatory reenactments, often using toys and other branded items to perform roles and create stories that act as a paratext to the canonical story elements. Jenkins calls attention to Boba Fett, the *Star Wars* bounty hunter, a phenomenon whereby paratexts, in the form of *Star Wars* character figures, redefined and extended the storyscape through children’s play. As the *Star Wars* characters were released as toys, Boba Fett became a very popular figure and was part of the imagination of children inventing stories around the figures. Boba Fett grew in popularity, and perhaps importance in the story imagined, and now has his own movie planned as part of the new *Star Wars* expansion. Invented Boba Fett stories became part of the *Star Wars* storyscape for the individual but also noncanonical in relation to the

storyscape. Before the recent canonical revision of the *Star Wars* Universe, Boba Fett had become a principle character in books and other media. The first-person experience of expanding, reliving, or inventing roles and events that become part of the participants' conception of the storyscape is another powerful affordance to leverage engagement and immersion in a storyscape. The Spock bobblehead toy below (Fig. 10) may seem silly and tangential, or properly analyzed as a marketing or monetization strategy, but as a paratext it can be another affordance to be used in storyscape expression.



**Figure 10** Spock bobblehead toy.

Anecdotally, I have found paratextual experiences to be profound in the recollection and discussion of individual relationships with the *Star Wars* storyscape. The emotional recollection of a four-year-old running down a hall with the Millennium Falcon held high over his head in full fantasy mode, a story told to me by one of my students during a Strasberg acting exercise (seven-year sense/memory) that had students narrating a walk through of locations from their youth, is conceptually linked by that

individual to the narrative and other experiences that comprise the *Star Wars* storyscape. This is not about being part of a storyworld and its physical properties but about the explanatory power of stories as ideas expressed through action.

Individual participation in the story (through active or passive engagement including role-playing or costume appropriation as well as the use of paratexts to create personal hooks to the story) provides a robust affordance to design into a storyscape. This affordance extends even to the senses of touch, smell, and sometimes taste—as in the example of food trucks affiliated with *Game of Thrones* distributing medieval-looking turkey drumsticks and scent boxes (Andersen 2011).

#### **2.5.4 Negative Capability, Extensions, and Migratory Cues**

I group negative capability and extensions as affordances of a storyscape together with the practical method of adding “migratory cues” to connect extensions or seed a work with openings to other narrative artifacts. Since a storyscape is not limited to a single work, the ability exists to fill in gaps, extend the story into other directions, or, in the case of migratory cues, point the participants to other media through cues in one medium. One application of these qualities and methods is an exploration of different subjective states, or narrators’ viewpoints, to tell a more richly contoured story. Another application of extensions leverages the encyclopedic affordance of digital media to provide greater depth of information for users inclined to explore extensions that have drillability as a feature of transmedia storytelling systems. This drillability manifests through the encyclopedic quality of digital media design. Jenkins (2007b) is right in pointing out that “the encyclopedic ambitions of transmedia texts often results in what might be seen as gaps or excesses in the unfolding of the story: that is, they introduce



potential plots which cannot be fully told or extra details which hint at more than can be revealed.” George Lucas did not conceive *Star Wars* with built-in gaps or excesses, but as it unfolded across media, the story naturally provided entry points for games and other media.

Quoting John Keats and applying his words to this medium as an affordance of negative capability, Long (2007, 53) states, “When applied to storytelling, *negative capability is the art of building strategic gaps into a narrative to evoke a delicious sense of ‘uncertainty, mystery, or doubt’ in the audience* (emphasis in original).” The idea of building in gaps as a method is distinct from Jenkins’s view that gaps arise naturally because of the scale of the transmedia enterprise, and instead Long (2007) defines negative capability as a conscious design affordance. Long (2007, 53) defines negative capability thusly: “simple references to people, places, or events external to the current narrative provide hints to the history of the characters and the larger world in which the story takes place. This empowers audiences to fill in the gaps in their own imaginations while leaving them curious to find out more”. These references can be constructed as “migratory cues” that can be used to move audiences to different media platforms that satisfy an individual user’s preferences for content or as part of a broader story.

In a storyscape, these affordances contribute by creating greater realism, expanding the market, or creating bridges to other parts of the whole. By adding more layers to the storyscape through extensions of story and character, the increased narrative detail and emotional context can heighten the realism or increase narrative pleasure. Jenkins (2007b) agrees: “The extension may add a greater sense of realism to the fiction as a whole.” Extensions are also a useful way to define and refer to elements of the

storyscape that clarify the elements of mythology and character or extend the story across new vectors or perspectives. Extensions have an economic aspect in that, “transmedia storytelling practices may expand the potential market for a property by creating different points of entry for different audience segments” (Jenkins 2007b). These different entry points are also story opportunities. Each participant will find media that suit his engagement with the story gestalts that I explore in later chapters, as well as the pleasures of each medium, in the context of stand-alone works of art. Jenkins (Jenkins 2009a) extends his view: “transmedia extensions, then, may focus on unexplored dimensions of the fictional world, as happens when *Star Wars* games pick up on particular groups—such as the bounty hunters or pod racers—and expands upon what was depicted in the films.” An effective use of this affordance is to devise a story model that supports multiple subjective vectors, which in turn allow multiple interpretations or the pleasure of discovering a more accurate and complex story model or character through experiencing different views.

This complex story model is often implemented through intermedial hooks, which Marc Ruppel (2012, 101) refers to as “migratory cues”: “the means through which various narrative paths are marked by an author and located by a user through activation patterns.” Joss Whedon refers to “doors” that are built into his stories for complex television shows like *Lost* that can be exploited later on. Long (2007, 139) issues a proclamation: “a storyteller looking to craft a potential transmedia narrative should carefully craft the world in which that story exists, and then make passing references to other cultures, characters, events, places, sciences or philosophies of that world during the course of the narrative to simultaneously spark audience imaginations through

negative capability and provide potential openings for future migratory cues.” While I tend to agree with Jenkins that this negative capability is implicit in these encyclopedic texts, the implementation of migratory cues and predesigned extensions are an important design affordance for a storyscape.

Examples are common. *The Animatrix* movie was an important extension for providing a backstory and history for *The Matrix* storyscape. It articulated a central opposition between man and machine. *Lost* incorporated a host of cues that were exploited in the alternate reality games between seasons, but also encouraged the encyclopedic and detective pleasures of the participants in unanticipated extensions that were like fan sites that documented their own work to decode the *Lost* stories. For the shippers, fans advocating for favored relationships on *Lost*, these cues provided a rich subtext of discussion expressed on “shipper” websites. The term *shipper* derives from *relationship* and developed on fan forums as early as the *X-Files* fan newsgroups. Shippers post in forums and blogs advocating or arguing those story arcs that support character romances they desire to see unfold. The most discussed example of migratory cues, linked to specific plot and character points, is the use of a letter in the *Matrix* storyscape that starts in *The Animatrix*, warning about a machine attack. This cue connects the fan to the *Enter the Matrix* video game, where a goal is to retrieve the letter. The letter is further discussed in the *Matrix Reloaded* feature film. Long (2007, 42) explains, “Each of these components makes a distinct and valuable contribution to the narrative whole, demonstrating the power of carefully orchestrated transmedia storytelling. Further, by establishing these migratory cues between the different extensions, the bonds between each of the extensions are strengthened, and the increased

value in experiencing the franchise as a whole becomes more readily apparent to an audience.”

### **2.5.5 Subjectivity and Extensions**

A unique quality of extensions and negative capability is the ability to describe a story from numerous vectors or narrative points of view. In the storyscape medium, the villain often has a chance to become a new form of protagonist—sometimes a hero and at other times a sympathetic figure—as motives are explained. Jenkins (2009a) explains: “A third function of transmedia extensions may be to show us the experiences and perspectives of secondary characters. . . . These kinds of extensions tap into longstanding readers’ interest in comparing and contrasting multiple subjective experiences of the same fictional events.” Subjectivity, in the form of a story structure that indicates multiple interpretations from different perspectives of character or audience, is a storyscape affordance to relate contrasting vectors of a story that differ from the single or primary story arc outlined by Aristotle’s coherent model. That model creates momentum toward the resolution by the protagonist of an emotional or ideological conflict—often resulting in an emotional catharsis for the viewer. A storyscape can embrace multiple points of view in an evolving open work. This offers a deeper level of complexity than stories that simplify an antagonist into a cartoon villain because traditional drama needed black and white characters and conflict to achieve narrative and emotional clarity. Narrative clarity is having no confusion about right and wrong, hero and villain, and conveys a clear point of view, and emotional conclusion. Cheering for “our side” at the conclusion is a common response in traditional storytelling; the clapping and cheering for the hero in most Hollywood movies illustrates that. A good example is the *Battlestar*

*Galactica* series, where subsequent TV movies and webisodes (*Battlestar Galactica*'s webisode series, *The Face of the Enemy*, and the TV movie *The Plan*) explored the concerns and points of view of the ostensible villains—the genocidal robot Cylons. After the additional explanatory character exposition, they turn out to be very sympathetic with understandable and charitable points of view, instead of an embodiment of the relentless evil to the human survivors the audience was expected to neither identify with nor root for. The subjective extensions affordance can be used in the open work of the storyscape to create a complex story matrix of different points of view that can merge into an encyclopedic and highly complex story model as it resolves mythopoetic story conflicts. In the case of *Battlestar Galactica*, it resolved the central mythic conflict between man and machines in a nuanced and complex resolution that was shades of gray instead of black and white.

### **2.5.6 Verisimilitude, Blurred Reality, and the Epistolary Form**

Reality, our reality, the world we live in and speak of as our day-to-day reality is used as an affordance of a storyscape. Blurring the line of what is real and what is fictional story is a common transmedia aesthetic across all models. Christy Dena (2009) describes this aesthetic as verisimilitude, where participants have direct interaction with the storyscape's story, spaces, or characters. This aesthetic and method is common in ARGs, used in role-playing as noted above, and invested in artifacts and works that convey the reality aesthetic. Starting with the first novel, *Robinson Crusoe*, which presented itself as a true memoir, and extending through Barthes' "new verisimilitude," which describes this aesthetic in modern literature, verisimilitude is not unique to the storyscape, but manifests as an affordance in media and experiences that are part of the

storyscape medium. The storyscape embraces this as a quality that affords many methods to engage the participant in a first-person experience or add the quality of a first-hand experience to the story. Digital versions of the epistolary form—writing, media, and websites—are a typical method that is employed. The converged affordances of the computer and the diverged affordances of a storyscape presented in real experiences lean toward the epistolary form, which can structure itself as a meta-medium of other media. Blurring the line between the fictional story and the real world is a desired feature of many implementations including the Nine Inch Nails *Year Zero* (Rose 2012), *I Love Bees* (Rose 2012), and the *Lost* alternate reality games that intruded into real-world events (I. Askwith et al. 2007). This adds these three verisimilitude methods as an affordance: TINAG (abbreviation for this is not a game), paratextual enactments represented as real events, and an epistolary transmedia form with “real” artifacts and real-time interaction.

Transmedia allows engagement in the first person with simulations, alternate reality games, theme parks, and fictional websites. The blurring of the line between reality and fiction is an established approach since the evolution of cross-media and transmedia approaches and, as Dena (2009) has noted, is also a theme in modern aesthetics. The design strategy flows from an assumption that the more “real” an “experience” is, the more pleasurable and emotionally effective it will be. Bolter and Grusin (2000) explain hypermediation as an aesthetic for a more “real” fictional experience. Janet Murray (1998) argues that a first-person immersive experience can be a more powerful and resonant experience, catalyzed through the new affordances of digital media.

The transformation of this aesthetic into a method or an affordance of the storyscape model is illustrated by the term TINAG, a convention that is prevalent in alternate reality games. TINAG was coined for the alternate reality game *I Love Bees*, which accompanied the movie *AI* by Steven Spielberg (Rose 2012). As Ryan (2012, 15) explains, “The TINAG convention is widely regarded as specific to ARGs, as compared to other types of games (e.g., sports games or board games). . . . It is by denying its own fictionality, by trying to pass as true, that fiction invites readers to participate in its game of make-believe and to immerse themselves in the storyworld. Just as a novel tells its story as fact, an ARG tells it through websites which look as if they contained real-world information.” TINAG is a consistent feature of most storyscapes, as they exploit the media platforms to create artifacts that appear to inhabit an imaginary world and, therefore, allow the participants to make-believe and increase their engagement and immersion.

This affordance is also implemented through paratexts that overlap with the diegetic story related across media and the participation of individual and groups using paratextual objects to be part of the reality aesthetic. Jenkins (2007b) elaborates, “we might see this performative dimension at play with the release of action figures which encourage children to construct their own stories about the fictional characters or costumes and role-playing games which invite us to immerse ourselves in the world of the fiction.” This builds on the blurring of reality as a distinguishing aesthetic of the storyscape.

The third method is the epistolary form, which has proven to be a rich way to engage and integrate an audience into the storyscape because of the web and social

media. From fictional websites to complex alternate reality games, the computer as a medium supports the hypertextual linkage of diverse “authentic” content made up of texts, pictures, and videos that can be unraveled through scavenger hunts or released over time. *Lost* made extensive use of this epistolary form in its alternate reality games between seasons by scattering stories across YouTube and mobile and social media, and staging real-world events where fictional characters intruded into our reality (I. Askwith et al. 2007). Ryan (2012) and Dena (2009) both point to a verisimilitude aesthetic in transmedia and its derivation from the earliest incarnations of epistolary fiction, such as *Robinson Crusoe*, which presented itself as a true story. Jenkins (2009a) describes the affordance for the design discussion of a storyscape: “We may learn a good deal about this aspect of transmedia by looking at the tradition of epistolary novels. Works like *Robinson Crusoe*, *Pamela*, or *Dracula*, constructed fictional diaries, letters, even transcripts. While they are contained within a single binder, they can be described as transmedia works insofar as they imitate multiple genres, including both manuscript and print forms of prose, and thus invite us to construct the fictional reality from these fragments.”

In conclusion, extracting design affordances from this aesthetic, the use of a blurred reality, participation in fictional events as a character or in a role, and the use of digital media to distribute and create a fictional reality for the participants are methods of a storyscape to access this verisimilitude affordance. This aesthetic of reality, as applied to storyscapes, is ironic in that imaginary worlds comprise many of these works. Storyscapes have limited correlation with the lived, contemporary reality, but the



participant can imagine a gestalt of the whole story and find immersion in it through their insertion into these blurred reality artifacts.

### **2.5.7 Four Affordances—Procedural, Participatory, Spatial, Encyclopedic**

Janet Murray (1998) contributes four key affordances to a design method for a storyscape: procedural, participatory, spatial, and encyclopedic. The affordances are engaged by participants in a storyscape and provide an accepted terminology to anchor the definitions used in the vocabulary developed in this document and by other theorists. These four underscore the media accepted as part of a storyscape, including video games, social media, and interactive narratives such as alternate reality games.

Murray (1998) also identifies immersion as a function of these qualities expressed in converged media. In the storyscape model, the converged media of the computer become part of the diverged media of the storyscape. This also pushes the definition of medium beyond a converged medium toward a medium consisting of distinct media. Thus the storyscape can be seen as a medium of media. Digital media scholars, including Murray (1998) and Manovich (2002), model a converged creative medium of the computer that contains all these digital affordances and is a medium for interactive stories. I contrast the storyscape model as a diverged medium because it is constituted of stand-alone discrete artifacts that are all part of one medium instead of converged into the single medium of the computer. And finally as Murray explores these qualities, she highlights dramatic agency as significant for the robustness of interactive narrative. Dramatic agency centers digital storyscape design around story participation though she references how these qualities contribute immersion to a story. Murray (1998, 71) explains the interaction in this way: “[the procedural and participatory properties] make

up most of what we mean by the vaguely used word interactive . . . [the spatial and encyclopedic properties] help to make digital creations seem as explorable and extensive as the actual world, making up much of what we mean when we say that cyberspace is *immersive*.” In this she anticipates the development of these affordances, such as participatory, that are extended in the storyscape, and enacted through games or ARGs. The employment of the computer’s encyclopedic qualities express as drillability, and spatial or procedural qualities are represented in video games and virtual worlds that are part of a storyscape. She highlights the immersive quality that emerges from these experiences and the heightened engagement from encouraging dramatic agency within a narrative structure. Overall, these qualities provide a foundation for understanding the evolving design methods and affordances for building a storyscape.

Transmedia theorists have consistently referred to and referenced Murray’s qualities as relevant for the diverged medium, in contrast to her focus on their application to a converged story medium. For example, Jenkins and others examine the pleasure some audience members receive from the encyclopedic affordances of digital media, which Jenkins (2009a) explains as “the desire of audiences to map and master as much as they can know about such universes, often through the production of charts, maps, and concordances.” This encyclopedic affordance is addressed previously as drillability. Jenkins (2004) also calls attention to the spatial quality of narrative games to reference other stories that draw from existing film or literary works or genres. Thus, games can employ the spatial affordance in a stand-alone medium to explore a canonical spatial storyscape and experience dramatic agency as part of a combined experience. In the *Walking Dead* storyscape, the *Walking Dead Game*, a dramatic game, does an excellent

job of placing the storyscape participant in the world, with dramatic agency to affect an outcome related, but not intrinsic, to the comic book or television series. It builds on the spatial, procedural, and participatory qualities to foster agency and immersion. That can contribute to the whole of the storyscape, enriching the other experiences through new converged affordances.

I use these examples of affordances and design methods, derived from qualities and theoretical topics, to construct a practice to situate the four gestalts. Starting with Murray's four affordances, and building upon them with the discussed affordances that are unique or representative of transmedia practice codifies a method to apply to a storyscape design. These topics were applied and referenced for the practical application of the implementation of the *Ghost Club* storyscape. Before discussing the four gestalts in depth as way to author a storyscape, the idea of story in a storyscape model must be examined. The four gestalts are predicated on the idea that there is a whole story to be read, comprehended, and experienced. The next section frames the big picture, explains how other scholars have grappled with it, and sets up the storyscape methods for designing around this story.

## **2.6 The Big Picture**

The storyscape model sprawls across stand-alone media, and in its exemplars, such as *Lost*, *Star Wars*, *The Walking Dead*, and antecedents, such as the Greek myths or medieval Christianity—as Ryan has pointed out transmedia storytelling could apply to the Biblical stories across media or the pilgrims' journey—the tendency to fragment is balanced with cohesion. The storyscape can be authored and designed to mitigate that fragmentation and encourage the users to comprehend a whole, coherent work. In

Jenkins's (2006a) early transmedia work, he examined where the story extends from medium to medium and how cues or plot points between media connect in a logical narrative order. In his original chapter on *The Matrix*, Jenkins (2006a) discusses how much work or effort must go into constructing and reading the larger narrative model that he posited as the new form: transmedia storytelling. Ryan, particularly in *Narrative Across Media* and its multiple chapters, understands the story as inhabiting, but also transcending, the medium of words, or in the case of cinema and television, words and images. Other transmedia theorists have proposed this mental construction as an aesthetic that makes sense of a whole story as a sum of its parts, or perhaps the whole is greater than the sum of its parts. Since the storyscape as described is a relatively new phenomenon, these mental constructions of a storyscape are tentative, but I review the consistencies in these models to extrapolate how participants stitch together the various media elements and conceive this extensive story medium (of media).

The storyscape exists as a whole because, no matter the number of parts experienced, a participant will be able to conceive and imagine a whole work. This is partly because imagination fills in or skips gaps so well, partly because it is a negotiation with a user's experiences and worldview, and partly because our comprehension requires a logical narrative system to make sense. The four gestalts are a story-centric dramatic method meant to create maximum comprehension and emotional resonances through multiple affordances combining to create a whole story—centered on a mythopoetic center. The construction of this whole work from discrete story and experience vectors works as a gestalt; where we can conceive a whole work. In Gestalt theory, the whole is *other* than the sum of its parts. It is constructed through qualities including emergence,

the constructive act of perception (reification), seeing an artifact or plot point differently according to the point of view (multistability), and the recognition of objects or branding in different media (invariance). Regardless of the process that allows an audience to conceptualize the whole story, transmedia and other theorists have grappled with the question of how that model works. In order to build this whole model, this analysis investigates how narrative is constructed and present in video games, how complex television forms a larger whole from episodes and transmedia, and how story fusion works across media.

This model of story is built on the classical forms of Aristotle's poetics expressed in modern books, movies, and plays. The aesthetics of the open work and the new affordances of the storyscape push this model beyond the traditional boundaries but these stories still embrace many of the same pleasures of the play. There are often beginnings, middles, and ends—though not necessarily in that order or limited to only one. Catharsis is a goal. Causality is encouraged. Character is a principle that is enhanced. The pleasures of spectacle, comedy, and mimetics are still part of the story. However, most importantly stories create or affirm cultural meaning through conflict. Bruner (1987) explains stories as another way of understanding the world distinct from logic. This work defines story within an evolving Aristotelian model. Story is the conceptual engine, conflict, and arcs that form the core that engage the participant.

Ryan (2004) is the main investigator in addressing two relevant concerns across her writings. The first is what part of the story works across media and in particular what that central formulation as story is. This is addressed abstractly in a way that will feed into the design method through the understanding of the meta-level of stories in a

storyscape, but also at the granular level of what affordances of media support referents or aspects of story. In discussing interactive narrative, Janet Murray (1998, 257) identifies three distinct types of viewers who enact that process: “the actively engaged real-time viewers who find suspense and satisfaction in each single episode; the more reflective long-term audience who look for coherent patterns in the story as a whole; the navigational viewer who takes pleasure in following the connections between different parts of the story and in discovering multiple arrangements of the same material.” The stand-alone aesthetic of the storyscape satisfies the first kind of viewer, but satisfying the other two viewers requires the construction of a larger single story model conceived as a whole. Jenkins (2006a, 129) expands on how unique affordances contribute to building that model in transmedia storytelling: “Younger consumers have become informational hunters and gatherers, taking pleasure in tracking down character backgrounds and plot points and making connections between different texts within the same franchise.” In his work on games in narrative, Jenkins draws a contrast between the story and plot that can be used to extrapolate a model of how a story is conceived across media. In those examples, he not only speaks about integrating narrative into games but explains how a reader can connect story across media to create narrative games, a controversial topic at the time. Jenkins (2004, 126) states:

Russian formalist critics make a useful distinction between plot (or *Syuzhet*) which refers to, in Kristen Thompson’s terms, ‘the structured set of all causal events as we see and hear them presented in the film itself,’ and story (or *fabula*), which refers to the viewer’s mental construction of the chronology of those events. . . . According to this model, narrative comprehension is an active process

by which viewers assemble and make hypotheses about likely narrative developments on the basis of information drawn from textual cues and clues. . . . As they move through the film, spectators test and reformulate their mental maps of the narrative action and the story space.

This process describes the formulation of the viewer's version of the story, and in a storyscape the need to conceive the story beyond the plot is a pivotal issue. Indeed, Jenkins (2011b) draws an early connection to mythology in noting that "we can still point to historical antecedents which were experimenting with notions of world building and mythology-modeled story structures in ways that include both radical intertextuality and multimodality." This signals the need to identify that core story, whatever it is, and how it comes together as a whole and is disbursed across media. For example, Jenkins (2004, 124) explains, "the *Star Wars* game exists in dialogue with the films, conveying new narrative experiences through its creative manipulation of environmental details." These new experiences contribute to that whole.

In the previous section, I proceeded from the discussion of the connection between games and narrative to propose that different entries can point to a central story structure. In complex or serial television, this construction of a story across media with a dominant television mothership is at work as viewers assemble a whole story from multiple media engagements. Jenkins (Jenkins 2009a) recalls the film distinction of story and plot to describe this mental construction of a whole story in this medium: "We might understand how serials work by falling back on a classic film studies distinction between story and plot. The story refers to our mental construction of what happened which can be formed only after we have absorbed all of the available chunks of information. The plot

refers to the sequence through which those bits of information have been made available to us.” And then later, he extends the argument by stating: “We can think of transmedia storytelling then as a hyperbolic version of the serial, where the chunks of meaningful and engaging story information have been dispersed not simply across multiple segments within the same medium, but rather across multiple media systems” (Jenkins 2009b). This mental construction, a storyscape, exists in two forms: the author’s or collaborative authors’ intention to tell the core story (the four gestalts), but also in the process by which the viewer apprehends and negotiates that story. This is a practical, as well as a theoretical, point of view. Dena (2009, 111) speaks to this mental construction of a whole story as a method of fusing these disparate parts:

Fusion does exist in transmedia projects, but it happens at an abstract level. It is characterized by a conceptual synthesis of separate media rather than an assemblage or transformation at the expressive or material level. The peculiar challenge of this approach is to bring together elements that are disparate, incompatible, or isolated, in a way that retains their independent nature. This approach does not try to change that which is manifest, but tries to find connections at a level that reconfigures them conceptually. The objects change, but that change happens around the materials, within the minds of those who design and experience them. Unity is perceived, variety is manifest.

Dena’s unity is that central mental process of story construction—that is not described solely by plot. The plot is only one of the multimodal forms of narrative. I argue that it is a series of gestalts that constitute the process—I have outlined these gestalts previously and will elaborate on them subsequently.



Games and films or other narrative media can be designed together fulfilling the linear plot function while also creating a meta-level of vectors and gestalt understandings at the level of story. As more complex forms of television and transmedia emerge, theorists must wrestle with a more extensive mental construct of a story.<sup>3</sup> As I segue into the discussion of the four gestalts that are used to design a storyscape, the focus is on a resonant whole. In my later mythopoeia discussion, I will delve into some of the fairy tales and mythic constructions applied to the storyscape medium. The research through design approach that is used here is meant to throw light on this problem through the understanding of how disbursed elements engage at the level of story and plot. It also explores how those elements or gestalts are relevant to specific media instantiations and whether story ideas are being expressed at a meta-level—and how they are being integrated individually and culturally.

### **2.6.1 Criticism of this Model of Transmedia Storytelling**

Some critical issues should be dealt with before moving into a discussion of mythopoeia, character, canon, and genre. The first topic is the idea of the computer, or digital media, or the future of storytelling as a converged medium. Many digital media theorists such as Lev Manovich (2002) and Henry Jenkins (2006a) have investigated that convergence as creative medium, through the computer, will consolidate all media in a converged narrative medium. Since the storyscape is about a grouping of stand-alone media works that I refer to as a diverged medium, the question has arisen whether

---

<sup>3</sup> My argument is that this is related to the historical dramatic structure of plot, character, and catharsis, adjusted for the open work and a revised poetics, but in contrast to a storyworld model.

transmedia, in general, is a transitional form. Janet Murray emphasizes this temporary nature in her paper, “Transcending Transmedia: Emerging Story Telling Structures for the Emerging Convergence Platforms.” She argues that transmedia storytelling is transitional. She proposes instead the evolution of a converged form based around the computer as a coherent single medium: “Although the current paradigm for expanded participatory storytelling is the ‘transmedia’ exploitation of the same storyworld on multiple platforms, it can be more productive to think of the digital medium as a single platform, combining all the functionalities we now associate with networked computers, game consoles, and conventionally delivered episodic television” (Murray 2012, 2). However, as I noted previously, the form of transmedia storytelling that is the focus of my research is a storyscape whose model explicitly contains multiple works that are complete and independent as well as part of a larger whole. Further, narrative and other aspects of the storyscape can be spread across media not conducive to an immersive experience or engage the audience at multiple experiential levels. These levels can be passive, as in a lean-back TV experience; lean-forward as in gaming; or even *lean-into*, a term I use to define user agency as part of the media experience, when relevant, for participatory dramatic media.

Murray (2012, 3) continues: “we can look at how television might continue to change as producers and viewers take advantage of digital affordances.” The form of a storyscape, as outlined previously, is about taking advantage of those affordances and also digital media, as it integrates storytelling with social media, performance, and games. Murray (2012, 3) reflects on the four previously mentioned characteristic affordances, arguing that “television is currently transmitted and stored in digital form

and is delivered on the same screen and often through the same device that provides access to video games and websites. . . . We can see the possibility of a future environment of true convergence in which everything we can do on a computer or a game console can also be done in the context of television viewing.” In this summary, she shapes the idea of a converged medium of digital affordances that will emerge as a new medium of media, encompassing games and web-based instrumentalities. However, the approach adopted in this research sums this equation in an opposite manner. The four gestalts and these affordances can be used to create a medium of media, but one that is not converged and whose model is founded on the dispersal of elements across stand-alone instances of texts, artifacts, and experiences so as to find the whole of the story assembled by the participant and participants as they negotiate the meaning of the whole work.

Whether games, websites, movies, or t-shirts, these objects contribute to the mental construction of the whole, the gestalt “Other” whole that exists as a story medium with coherence, meaning, and focus. This is what I refer to as a medium of media, a diverged medium that stands in opposition to Murray’s criticism and the conception of the computer as the converged medium for storytelling.

### **2.6.2 Transmedia and Coherence: Bordwell and Thompson**

In considering the story as a whole, coherence is often a central issue and concern. Other modern effects, including nonlinear narrative, also have consequences for story comprehension. In transmedia, coherence is important, because the nature of the medium offers challenges. For Long, that means extolling canon as primary and, therefore, a solution. More critically, Bordwell and Thompson (2010) are less willing to separate

story and plot in their criticisms of the transmedia form and specifically as a rebuttal to Jenkins's proposed transmedia storytelling model presented in *Convergence Culture*. The effort of assembling clues, following story paths, and imagining a whole story in this model of transmedia storytelling is viewed as having a negative, or catastrophic, impact on comprehension. The affordances of a story told across media is regarded by them as a barrier to the frame that makes a story resonant, or at minimum creates damaging drawbacks to comprehension and narrative satisfaction. In their discussion of transmedia on their blog, Bordwell and Thomson (2010) assert that this mode of storytelling breaks the model of story so completely as to render it ineffectual and incomplete: "Another drawback to shifting a story among platforms: artworks gain strength by having firm boundaries. A movie's opening deserves to be treated as a distinct portal, a privileged point of access, and a punctual moment at which we can take a breath and plunge into the story world. Likewise, the closing ought to be palpable, even if it's a diminuendo or an unresolved chord. The special thrill of beginning and ending can be vitiated if we come to see the first shots as just continuations of the webisode, and closing images as something to be stitched to more stuff unfolding online. There's a reason that pictures have frames." In my personal experience with the ending of *Lost*, this point has merit, because I was confused about the frame of *Lost*, since it extends, as an open text related to other open texts, indefinitely. The *Lost* fan community has also made the ending a significant topic of discussion and argument. Fans missed closure to the series, due to multiple engagements, interpretations, and expectations exposing the multiple frames that Bordwell and Thompson suggest. Perhaps, this is because I required more of Jenkins's "synergistic storytelling" or, as Bordwell and Thompson suggest, because the model of

storytelling that is embraced will inherently lead to an unsatisfying result. The storyscape model provides greater affordances, more visceral ways to connect to an audience but not without potential narrative consequences for how stories are experienced and understood. The classic Hollywood hero and villain provided moral clarity, but not the most nuanced vision of the world. *Lost* may have wavered in clarity, but still showed a narrative form that grappled with a multimodal, multimedia, and more complex story medium negotiated between participants and authors.

Marie-Laure Ryan (2006b), in her analysis of new media story structures, also illustrates that a rhizome-like model of story will compromise understanding because not all viewers are getting the same information in the same order. Therefore, the viewers will have variable experiences and understandings and may be deprived of the most resonant or satisfying conclusion. Bordwell and Thompson (2010) address the same topic by stating: “Facing multiple points of access, no two consumers are likely to encounter story information in the same order. If I start a novel at chapter one, and you start it at chapter ten, we simply haven’t experienced the art work the same way.” They are saying the ordering by the authors and the “shared” experience of that order is essential for the story to act as an individual and cultural meaning-making system; otherwise, it becomes chaotic, and meaning and closure are lost. Bordwell and Thompson (2010) continue: “In between opening and closing, the order in which we get story information is crucial to our experience of the story world. Suspense, curiosity, surprise, and concern for characters—all are created by the sequencing of story action programmed into the movie.” Bordwell and Thompson fault transmedia storytelling for weakening or undermining authorial intention, disrupting the build of narrative information that moves

us toward a shared understanding, and, I infer, breaking the story so that it is no longer conclusive or effective.

The answer to this criticism is twofold. First, the previous discussion incorporates the transmedia field's attempt to reconcile these criticisms with the methods required to design a whole story, so it holds together. Perhaps, Bordwell and Thompson should revisit their own discussion of story and plot and seek a more robust model of the story that extends across media, as Ryan seeks to achieve. Secondly, every story form has its limitations. From a design perspective, Bordwell and Thompson elaborate design constraints and the consequences to be considered, but breaking these constraints is not necessarily catastrophic. Overall coherence is sometimes lost, and when canon changes radically, this is an important consideration for design. This is another reason that canon, as a gestalt, holds the storyscape together. Catharsis may be endangered, but with a foundation of stand-alone works, each can be successful within its own frame. Further, extensions and other works that deepen the connection, understanding, and immersion can enhance the frame. Nonetheless, from a design standpoint, this narrative dispersion and the case of transfiction plot points present a challenge for comprehension and possible audience dissatisfaction. I speak to this in chapter 4 about *Lost* as an exemplar, where the best and worse features of comprehension in this medium were experienced.

This also stems from a model built across media that implies more effort, or work, than an audience will contribute and that the participants' results will be tied to that effort in order to successfully comprehend a storyscape. *Lost* was an example of how Aarseth's definition of ergodic, or working path, defined different user experiences and story perceptions. He identifies the users' liability: "The ergodic work of art is one that in a

material sense includes the rules for its own use, a work that has certain requirements built in that automatically distinguishes between successful and unsuccessful users” (Aarseth 1997, 179). This echoes Jenkins’s “privileged users” and criticism discussed in the “Unicorn” essay that the storyscape form requires too much work. However, if you separate the work required to consume all the plot points from the mental construction of the story, then participants will be able to conceive a whole regardless of whether they sample all the related works. The beauty of the storyscape model is that users can join in only by sampling the parts that speak to their way of knowing the world and the pleasures that appeal to them. Gardner (1999) speaks of eight forms of intelligence and knowing the world; a storyscape can engage on all or a portion that maps best to a participant’s innate ways of understanding. Murray and Jenkins were both quoted previously reinforcing the model of storyscape participation of a diverse audience, made of collectors, detectives, observers, games players, and passive participants in a story ecosystem that enfolds them all.

## CHAPTER 3

### STORYSCAPE DESIGN AND THE FOUR GESTALTS

Branded entertainment comes and goes in a flash, but transmedia storylines are timeless because they are built on a foundation of classic narrative structure. They're good stories.  
—Gomez, *Jeff Gomez*

Through his company Starlight Runner, Jeff Gomez, one of the principle architects of transmedia stories for The Walt Disney Company (*Pirates of the Caribbean*, *Tron Legacy*), 20th Century Fox (James Cameron's *Avatar*), Sony Pictures Entertainment (*Men in Black 3*), Coca-Cola (*Happiness Factory*), and Hasbro (*Transformers*), always puts story at the center of the creation of a good transmedia project, franchise, or campaign. What is a good story? It is the subjective quality that defines the story and its parts. The perspective of this research is how to tell a good story in the medium of a storyscape. No formula results in a good story but for this model the four gestalts expand the craft of storytelling for this evolving medium. Exploring storytelling in the storyscape is rooted in a desire to understand the creative practice, but also to align that with an academic vocabulary.

In this chapter, I will define a design vocabulary and describe an ecology of gestalts to build storyscapes and analyze transmedia storytelling. By an ecology, I mean that the storyscape medium acts as a living ecology that grows, interacts, and enfolds its audience as readers, users, and participants. In general, I try to adopt the use of the word *participants* to describe the engagement of the audience of this medium. Many authors, including Christy Dena, Marie-Laure Ryan, Henry Jenkins, Kalstrup and Tosca, and Thompson and Bordwell, have described transmedia storytelling as a new medium to tell



stories. Digital media storytelling has yielded new mixed forms such as story-games, video games that aspire to be storytelling mediums; alternate reality games (ARG), stories mixed with games played online and in the real world; augmented reality games, played with devices that mediate the world; and evolving transmedia mixtures that are tied together under a franchise (an industry term indicating transmedia exploitation) or more significantly comprise a related body of transmedia storytelling works.

A subset of this group of works across media is what I call a *storyscape*; I use the term *storyscape* to contrast a story-driven approach—derived from classical narrative principles—against the world-building or world-based practices and analysis. These principles include plot, character, catharsis, and closure, as discussed previously, or a well-formed beginning, middle, and end. The evolution of the classical narrative models contributes to the development of an expanded definition of a well-structured story for the storyscape, and how that story model may achieve different forms of catharsis. There could be multiple catharses in the context of a storyscape across a series of movies, for example, or they could build upon one another with the depth and resonance of the story in the participants’ connected experiences and memory. Perhaps catharsis will be simply one aesthetic quality or pleasure among many in this medium.

A storyscape is the grouping of story-related works and communities across media. The storyscape must have an authorial voice (individual or communal) to determine the meaning-making systems of myth-making, character, canon, and genre. This grouping must contain original content, in different media not solely remediated or repurposed, that forms experiences or stories that extend the storyscape to form what can be imagined as a whole text. A storyscape may be partly remediated from one medium to

another, as a novel to a movie, but most storyscapes are constituted of story parts that are additive or synergistic (Jenkins 2007b). The central aspect of storyscapes is to frame the relationship between the parts to the whole as gestalts. A storyscape is the sum total of all the media manifestations of a central mythology and also includes the community, brand, and cultural zeitgeist that surrounds a storyscape.

Further, I propose this list of requirements to clarify further the medium being investigated. Not all requirements are mandated, but the examples discussed throughout this thesis, and in practice and academic references, fall easily into this category. This category has aesthetic qualities, such as a relation to imaginary worlds, as defined by Mark Wolf (2013), that further highlight the storyscape as a new medium. These requirements will also lead directly to the four gestalts and the central story practices embedded in the section on mythology and its practice in a storyscape.

1. A storyscape must have at least three stand-alone, of different media, artifacts that do not repurpose or adapt other parts of the story.
2. There is an authorial vision.
3. There are a unifying story or stories that express central cultural themes or conflicts.
4. Storyscapes are imaginary worlds. For the purpose of this research, and all the examples within, imaginary worlds are an element of a storyscape. Imaginary worlds also distinguish the storyscape from other definitions of storyworlds or transmedia storytelling

5. Storyscapes are usually supernatural. Whether magic or advanced science that behaves like magic, this medium can be seen to descend from fairy stories, as outlined by Tolkien (1966).
6. Storyscapes are mythic. In all examples mentioned, there is a conscious act of mythopoeia, myth-making, that incorporates and aspires to be a myth. In this meaning, that new myth, allied with the central truth of the old myth, can merge into a new cultural truth, relevant for its audience.

This narrow definition of transmedia storytelling, forming the storyscape and its examples, refines the design vocabulary and narrows the research. Not all of these practices must be present in a storyscape, and perhaps this design vocabulary will find usefulness beyond the storyscape, but this definition drives the discussion of the four gestalts and their applicability to this medium. These definitions and rules focus a core vocabulary and the set of unifying gestalts needed to design a story in the storyscape medium.

This thesis contributes to a new design vocabulary by offering working definitions of four key terms for the construction and analysis of a storyscape. These four terms—mythopoeia, genre, canon, and character—are drawn from both academic discourse and prevailing industry practices. These terms also allow the formulation of a story design process to look at the relationships between media and the creation of a storyscape in practice. To plan a robust storyscape, the main working parts and considerations must be derived so as to model a whole work comprised of disparate parts. To communicate those parts in a working environment that supports multiple creative voices and different production processes across media, a common vocabulary and an

understanding of how the pieces of the ecology fit together need to be codified.

I call these relationships *an ecology*, because it ties together what I consider to be four main gestalts in the creation of stories with a multimodal practice that engages the participants individually, depending on their subjective preferences for different media. The eight forms of intelligence as discussed by Howard Gardner (1996), musical–rhythmic, visual–spatial, verbal–linguistic, logical–mathematical, bodily–kinesthetic, interpersonal, intrapersonal, and naturalistic, act as a model for the ways participants negotiate the meaning and relevance of a storyscape, and also create their mental construct of the overall story. Gardner’s intelligences provide a shorthand way of defining diverse forms of engagement with a story. For example, logical–mathematical people may be attracted to plot puzzles such as *Lost* provided, while another may appreciate the visual–spatial quality of a *Star Wars* game or theme park experience. A storyscape can engage a participant in every way through the combined communication modes of different media. By examining how participants consume stories through discrete ways of knowing the reified story elements of mythology, canon, genre, and character, it is seen how a storyscape is evolving into a richer, new form of storytelling by relating to our multiple, subjective conceptions. For example, the shippers of *Lost*, focused their enthusiasm on the interpersonal relations of the characters in user-created forums. Their story and media were different from the logical–mathematical problem solvers, who obsessed with understanding the evolving mythology in the context of imaginary scientific principles. Each medium may only contain a subset of these ways of knowing, and each participant may only also apply a subset of interests to a storyscape’s artifacts, but a storyscape can tie this ecology together using the four gestalts.

The storyscape is a medium of media, and therefore a definition of medium is called for here. Ryan's (2003) *On Defining Narrative Media* provides the basis. She starts by using the *Webster's* definition of a medium:

- (1) A channel or system of communication, information, or entertainment.
- (2) Material or technical means of artistic expression.

The distinct media of the storyscape—games, video, movies, and comics—are easily recognized as media. Ryan leverages a typology and table created by Celia Pearce (1997) to define the channels and modalities of various media. This table (Table 1) can be seen below. My definition of media expands the synthesis of all channels, presented below as a medium of multiple channels to the storyscape. The storyscape is a medium of media that is a channel and medium of communication with a broad set of affordances, specific to the medium and documented in chapter 2. As Ryan (2003) says: “Media such as music, dance, and painting—media without language channel—specialize in the retelling function; but as they give new semiotic bodies to familiar stories, they do much more than bring these stories to mind: they recreate what they recall, and end up producing original versions” In the storyscape, the multiple media allow the larger story connection to be imagined and unify the diverse media, across time and different media grammars, into a single whole narrative medium.

Table 1 A Typology of media that affects narrativity.

Temporal		Spatial		Spatio-Temporal	
One channel		Two channels	One channel	One channel	Multiple channels
Linguistic	Acoustic	Linguistic-Acoustic	Visual /static	Visual / kinetic	Acoustic-visual (kinetic)
<i>Media of long distance oral communication: Radio, telephone</i>  <i>Manuscript writing, Genre: letters</i>  <i>Print writing in various supports. Submedia: Books, Newspapers</i>  <i>Digital writing. Submedia: e-mail, internet chat, hypertext (text-only)</i>	<i>Music</i>	<i>Songs with lyrics, sung poetry</i>	<i>Painting</i>  <i>Sculpture</i>  <i>Photography</i>  <i>Architecture (?)</i>	<i>Mime</i>  <i>Animated graphics</i>  <i>Silent movies without music</i>	<i>Dance</i> <i>Silent movies with live music</i>
					<i>Linguistic-visual (static)</i> <i>Illustrated books, Genres: Comic strips, Artist's books, children's books</i>
					<i>Linguistic-visual (kinetic)</i> <i>Face-to-face oral communication</i>
					<i>Linguistic-Acoustic-Visual (kinetic)</i> <i>Cinema, Theater, TV, Opera</i>
					<i>Synthesis of all channels</i> <i>Computer-mediated forms of expression. Submedia: Web pages, Art CD ROMs, Computer games, Hypertext (multi-media), Virtual reality</i>

Table 1  
A typology of media that affect narrativity

What other reasons drive a common design vocabulary? Practitioners in the field need to be able to communicate. There is a need to discuss aspects across media practices. In a storyscape, there are often expansions of stories that extend out into other

media. These extensions form a kind of exquisite corpse with lines that are drawn from one medium continuing into another. These lines change according to the affordances of the medium. Thus, consistent vocabulary is required to develop these synergistic experiences. Furthermore, a vocabulary that helps define the ecology of the story relevant to our ways of knowing and remembering is important in retaining control of the meaning structures of the ecology from an authorial point of view.

In this section, I discuss the meaning and usage of the four gestalts that can link participants' experiences across different media. These conceptual connectors were extrapolated from academic analysis and practical methodologies that have evolved in media research and transmedia storytelling. I will review practical methods and vocabulary related to these four gestalts. These methods are partly unstructured, perhaps because they flow from a nonacademic approach that sometimes lacks consistency, clarity, and rigor. Examples of transmedia storytelling references quickly slide into the anecdotal and undocumented. Nevertheless, there is a rich lode of material to mine, as the nature of transmedia storytelling has also provided the medium to record and interrogate its own production process through social media, DVD extras, and other forums for participants. From journalism about transmedia projects to discussions by creators and authors, there is a useful corpus of information to draw upon for an examination of design methods to combine with the previous chapter's theoretical concepts, methods, and vocabulary.

This chapter will also address in detail the four gestalts, mythology, character, canon, and genre, and how those form the unifying whole of the storyscape with an integration of the theoretical and methodological contributions of media academics.

Some analysts have focused exclusively on of my gestalts, such as Geoffrey Long (2007), who highlights the importance of canon, and Elizabeth Jane Evans (2008), who focuses on character in transmedia storytelling. On the other hand, myth-making and mythology, developed extensively by Jenkins (2006) as a subset of world-building and Gomez (2014) in practice, has been considered a significant topic despite a lack of definition, multiple definitions, and approaches that relegated it to a subcategory of canon, world-building, or only continuity. Examining these and other transmedia scholars, transmedia practice, and the research through the design of the *Ghost Club* storyscape yields this model of the four gestalts as a practical and theoretical model for the design of a storyscape.

### **3.1 A Definition of Myth for a Storyscape**

The section concerns the definition of myth and its definable qualities for the purpose of exploring the question: does a storyscape affect the cultural connections and transmission of meaning we build by using stories? I argue that we can trace these stories through myths that are *remediated* across media, and I will investigate the way elements of myths remain clear, get lost, and are changed moving between media. Various approaches to be addressed will be archetypal, dialectical, anthropological, and linguistic/semiotic. I will show that the binary opposition that is represented in Claude Levi-Strauss's (1972) "Structural Study of Myth" can be used to construct and to examine the storyscape design.

#### **3.1.1 How Myth Defines the Structure of Stories**

This chapter looks at myth-making for a storyscape. The study of myth is situated in many fields that have emerged over the twentieth century. Initially, the organization of myths into categories (or morphologies) from a wide variety of cultures in a field called



comparative mythology (Herman, Jahn, and Ryan 2005) and including the reduction to quantifiable narrative structures by Vladimir Propp and Joseph Campbell (Ryan 2004). Extending into the realm of psychology, Freud (1930) touched on myths and how they operate as cultural representation systems and Jung (1981) used archetypes as a mythic structure for the contemporary interpretation of cultural artifacts and the collective unconscious of symbols—but for the purpose of this discussion we won't digress into the psychological approach nor attempt to apply it to a narrative analysis.

The scholars I review and draw from are Claude Levi-Strauss (1983a) and “The Structural Study of Myth” and Roland Barthes (1972) in *Mythologies*. I advance the argument that myth as a meaning-making cultural expression is represented in transmedia storytelling (Jenkins 2006a)—stories that unfold across various media: movies, TV, games, ARG, comics, portable devices, and other media platforms. Storyscapes can be authored and analyzed based on the binary opposition and dialectical structures of narratives as contemporary mythologies (Barthes 1977; Lévi-Strauss 1972). This is of importance because it allows us to see how cultural myths are being transmitted, adapted, and coauthored in the storyscape.

### **3.1.2 The History of the Study of Myth**

Religious myths and common folklore have existed from the earliest stories and religions and have been addressed and commented upon by thinkers throughout history, but myths came under analytical scrutiny in both the nineteenth and the twentieth centuries. Often, at first, men such as Durkheim and Frazier studied myths in the anthropological context of religion. Then and now, in Levi-Strauss's (1972, 428) words, “Myths are still widely interpreted in conflicting ways: collective dreams, the outcome of

a kind of esthetic play, the foundation of ritual. . . . Mythological figures are considered as personified abstractions, divinized heroes or decayed gods” or as Ronald Wright (2004, 4), a science writer, defines the meaning making structure of myth, “myth is an arrangement of the past, whether real or imagined, in patterns that reinforce a culture’s deepest meanings and aspirations. . . . Myths are so fraught with meaning that we live and die by them. They are the maps by which cultures navigate through time.” These quotes speak to why myth-making, and the creation of a storyscape mythology, can become an engine for this story across media. These quotes emphasize the relevance of a myth. It is this relevance, and the power with which it resonates, that animates and powers the storyscape. It is this resonance that makes a good story.

#### 3.1.2.1 Morphology and $F_x(a): F_y(b) \approx F_x(b): F_{a-1}(y)$

The study of the structure of myth contributes to an authorial method for the storyscape mythology. Vladimir Propp and Claude Levi-Strauss developed separate (Dundes 1997) but similar ways to approach the diversity of myth and to identify an infrastructure that would show its form as a means of analysis. Propp (1958) in his well-known *Morphology of the Folktale* lists a litany of plot points that he identifies as consistent across Russian folktales. Levi-Strauss generates structures by examining linguistic structures that provide meaning as they evolve over time or through a comparison of parallel myths in different cultures. Levi-Strauss’s methodology was criticized as reductionist (Dundes 1997), since it often tried to create an analysis that ignored meaning and focused on a mathematical structure of the parallel myths. From an authorial point of view for a storyscape, this is too reductionist a way to think about the

myth-making gestalt. This quotation from “The Structural Study of Myth” illustrates the problem:

It seems that every myth (considered as the aggregate of all its variants) corresponds to a formula of the following type:

$$F_x(a): F_y(b) \approx F_x(b): F_{a-1}(y)$$

Here, with two terms, *a* and *b*, being given as well as two functions, *x* and *y*, of these terms, it is assumed that a relation of equivalence exists between two situations defined respectively by an inversion of *terms* and *relations*, under two conditions: (1) that one term be replaced by its opposite (in the above formula, *a* and *a-1*); (2) that an inversion be made between the *function value* and the *term value* of two elements (above, *y* and *a*). (Lévi-Strauss 1972, 228)

This attempt to create a deterministic model illustrates the reductionist tendencies of twentieth-century analytic approaches to myth that yield little design value for a storyscape’s myth-making gestalt. No formula is adequate for capturing the mythopoeia. However, joined with other mythic semiotic references and the aesthetic gestalt of genre, Levi-Strauss’s binary opposition or Barthes’ mythologies can identify the meaning-making structures in storyscape myth-making and lead to their remediation across media artifacts. Understanding that stories have a decipherable structure to resolve moral and story conflicts assists in designing how to explore this across media. It provides a methodology to read the storyscape medium.

The structured story points of Propp, Levi-Strauss, and Campbell may seem simplistic but in the storyscape they also provide a structural affordance exercised across media. One person, I don't wish to name so as not to give credibility to his thesis (Vogler 2007), argues that all movies mirror the formula of Campbell's hero's journey. Understanding the segmentation of story elements illustrated above as narrative points can translate into the organization in a game medium. It can also provide an understanding how myths revisit different points of view in a storyscape through the restructuring of mythic structures for different media. For example, the evil Cylon machines of *Battlestar Galactica* revise the mythic conflict in the spin-off movie *The Plan*, to become the protagonists, thus including a mirror of the hero's journey inverting the roles for that transmedia story.

### 3.1.2.2 Myth in Culture: Ryan, Jenkins, Sturken, and Cartwright

Myth has two main functions. The first is to answer the sort of awkward questions that children ask, such as: "Who made the world? How will it end? Who was the first man? Where do souls go after death?" . . . The second function of myth is to justify an existing social system and account for traditional rites and customs.

—Robert Graves, "Introduction," *New Larousse Encyclopedia of Mythology*

Next I will address some contemporary scholars who touched on myth as a meaning-creation system and also show how contemporary stories function as myths. Henry Jenkins (2007a, 103) in "Exploring Feminism" says, "All myth depends upon the creation of moral distinctions through the manipulation of stereotypes. The making of a new myth, a feminist counter-myth, which challenges the dominance of patriarchal values depends as much on the creation of order through stereotyping as does the myth-making process which holds the old order in place. The question is what stereotypes are evoked, whose interests do they serve, and what conception of the world do they

shorthand.” Jenkins argues how myth works on large cultural values by creating meaning and counter meaning in an evolving cultural representation through story and images.

Marie-Laure Ryan (2001, 13) wrote about some of these mythic structures that apply to interactive narrative in “Beyond Myth and Metaphor”:

Adventure and role-playing games implement the archetypal plot that has been described by Joseph Campbell and Vladimir Propp: the quest of the hero across a land filled with many dangers to defeat evil forces and conquer a desirable object. The main deviance from the archetype is that the hero can lose, and that the adventure never ends. In most action games, this archetype is further narrowed down to the pattern that underlies all wars, sports competition, and religious myth, namely the fight between good (me) and evil (the other) for dominance of the world.

The important lesson in Ryan’s thoughts is that there is a centrality of myth in narrative structure. The way that structure informs new media and our relationship to them validates the use of myth-making in a storyscape as the meaning-making structure.

When looking at meaning creation across media platforms, it is helpful to revisit Jenkins on foundational narrative and what functions as myth-making by fans in contrast to a canonical (copyrighted) mythic/story structure. Henry Jenkins’s (2006a, 285) definition derives from Laurel, “Foundational narrative: According to Brenda Laurel, ‘a myth or set of stories or history or chronology’ that helps to define roles and goals for participants, whether commercially, as authorized artists, or grassroots community members.” Bordwell (Ryan 2004, 204) in his chapter speaks of how,

By and large neo-structuralist narratology . . . strategy has been to distinguish basic units or features of narrative and identify their presence in particular films. In this respect neo-structuralist narratology has continued the largely taxonomic enterprise of Propp, Todorov, and Genette. By contrast, a functionalist perspective links to a tradition that includes Aristotle, much work of the Russian formalist tradition.

This moves the mythic method closer to a modern practice and further refines the definition of myth toward understanding the way story works. This is a practical authorial method as opposed to creating taxonomies.

Sturken and Cartwright's (2009, 19) define myth in their book *Practices of Looking* as a "term used by French theorist Roland Barthes to refer to the ideological meaning of a sign that is expressed through connotation. According to Barthes, myth is the hidden set of rules, codes, and conventions through which meanings which are in reality specific to certain groups, are rendered universal and given for whole society." This illustrates how myths can represent a high-level set of signification, of codes, and through the articulation of that narrative structure a power to create and embed meaning. This application of Roland Barthes's analysis leads us to a constructive definition of contemporary myth, as a cultural opposition of meaning, that through its synthesis, creates meaning structures that form the core of stories, and the way they engage an audience in resonant meaning. Barthes's mythologies offers a perfect dichotomy for a uniting of theory in practice in the storyscape. In the initial chapters, he poetically analyzes the mythic dimensions, history, and oppositions that explain the topics he explores as narratives. In the analytical section, he presents a semiotic methodology

aimed principally at ideological interpretation. In a storyscape, an author can understand that balancing the mythic experience through story can be helped through an understanding of a semiotic point of view. Presumably, scholars can then speak directly to the creative practice and connect the ineffable story gestalts of myth-making to a scholarly discourse.

### **3.1.3 Levi-Strauss and Barthes—Toward a Model of a Myth as a Structure for Stories**

Barthes and Levi-Strauss provide key foundational elements to create a useable model of myth as a central story engine in narrative that can be examined as it extends across media. First, reviewing the theory of binary opposition in Barthes and Levi-Strauss, Levi-Strauss has this to say of “mythemes,” his neologism intended to refer to basic units of myth: “Of course, all mythemes of whatever kind, must, generally speaking, lend themselves to binary operations, since such operations are an inherent feature of the means invented by nature to make possible the functioning of language and thought” (Lévi-Strauss 1981, 4:559). To be sure, Levi-Strauss was aware that he was been accused of “the notion of binary opposition” (Dundes 1997). I argue this binary opposition can be applied to narrative design through the conscious act of myth-making in a storyscape. In the Jeff Gomez examples noted previously, he sees his task as pulling out the central mythic elements that were consciously or subconsciously created as part of the storytelling process, the important parts that resonate with audiences, and codifying them as principles in his story bibles and mythologies. What was an unconscious process for single works of film or literature becomes conscious as those dramatic conflicts echo, resonate, and harmonize across media.

Levi-Strauss (1955, 440) goes on to say: “that mythical thought always works from the awareness of oppositions toward their progressive mediation” and further that “the purpose of myth is to provide a logical model capable of overcoming a contradiction (an impossible achievement if, as it happens, the contradiction is real)” (Lévi-Strauss 1955, 443). This contradiction, such as science and religion in *Lost*, resolves itself across the storyscape as the whole story medium. As to the purpose of this process, he goes on to say, “a theoretically infinite number of slates will be generated, each one slightly different from the others” (Lévi-Strauss 1955, 443). In *Lost*, the television series, the authors exploited a series of oppositions to create mythic oppositions to power the story toward a resolution that reconciles the science and religion—if not satisfactorily for all audiences. So this concept—which resembles a dialectical approach and also the typical flow of plot in contemporary story (set-up conflict, main conflict, climax of conflict, and resolution of conflict)—can be a practical example of mythopoeia to connect a storyscape in a comprehensive gestalt. This model is capable of overcoming a contradiction between two conflicting ideas—ideas that have a larger cultural significance and signifying pattern—to create resolution, if not a catharsis, in a storyscape medium. Barthes (1977, 80) in *Image Music Text* reminds us that, “Keeping simply to modern times, the Russian Formalists, Propp and Levi-Strauss have taught us to recognize the following dilemma: either a narrative is merely a rambling collection of events, in which case nothing can be said about it other than by referring back to the storyteller’s (the author’s) art, talent or genius—all mythical forms of chance—or else it



shares with other narratives a common structure which is open to analysis, no matter how much patience its formulation requires.”

In Barthes, we see the use of the mythological methodology as a way to use binary oppositions to illuminate semiotic connections and the creation of meaning through the synthesis of opposing concepts. In understanding that mythological meaning formulation in the context of its naturalizing and semiotic reconsolidation effects, Barthes offers a tool for analyzing this meaning engine at the heart of our narrative cultural expressions. This is of value in finding a method for designing a storyscape and understanding why it has a popular cultural relevance. In Levi-Strauss, we see the formal use of a binary structure as a way of observing the binary opposition and meaning structure as it “slated” through time a myth that seeps to the surface. Or it can be seen in a storyscape, across media, and in contrast to other similar oppositional myths that make for a connected morphology.

For the mythopoeic gestalt, binary oppositions drive a mythic ecosystem. These oppositions work as a dialectal story engine that addresses meta-cultural concerns and meaning creation by setting up opposing concepts and then allowing them to achieve a synthesis across creative forms such as movies, games, webisodes, augmented reality, and worlds. This is a corollary of the central engine of conflict that Aristotle (1968) touches on in his discussion of plot in *Poetics*. A significant difference between this model and the Aristotelian one is that in the open system of storytelling of the storyscape the resolution of the central conflict is not restricted to any particular text. This is illustrated in the mythic story arcs of the *Battlestar Galactica* series bible, which aim to tell a story across more than a single text, as shown below.

### 3.2 Mythology and Mythopoeia

Mythology has been, and continues to be, a complex term with many meanings. It occupies a commonly invoked analytical position by scholars and pundits in defining truth and falsehood, and vast cultural constructs of deep and resonant meaning from the past and present. I researched and sought other terms that were less freighted but mythology is often used in practice and academic discussions of transmedia storytelling and related scholarship. Therefore, it becomes a bridge between theory and practice, and subsequently as I intend to show, a story-centric method of transmedia storytelling. The storyscape and various transmedial story practices suggest that there are two new definitions of mythology for a storyscape that need to be added to the traditional ones.

These two definitions are as follows:

1. Mythology: the documentation and creation of explanatory and unifying elements for a complex television series, a transmedia story, or a storyscape. These elements can be meta-narratives, central conflicts or themes, backstory, geography, magical or scientific rule sets, imaginary ecosystems, or archetypal characters. This is an artifact of the writing process that evolved from the TV series story bible and is still called a story bible. As works are created and declared canonical, they became part of the established mythology. Inasmuch as the initial mythology is not yet expressed in public works, and no one but the creators view and participate in their creation then it does not have to be complete, or canonical, until exposed through publication. *Lost* had a complex and much-discussed mythology that determined the course and conclusion of the series.

2. (Mythopoeia) Mythology: the creation of coherent works of an authorial authority as a result of directed myth-making, or mythopoeia. The author or authors make a conscious effort to invoke, reference, or re-conceive old myths into a new mythology. While scholars and storytellers have used mythology to express this definition, I will employ mythopoeia or myth-making to express the gestalt for the storyscape. George Lucas consciously repurposed mythology, specifically the Hero's Journey, in the *Star Wars* franchise and the Wachowski siblings invoked numerous myths in the *Matrix* storyscape. This myth-making process represents an attempt to find truth, even universal truth, in the created mythology, in contrast to the false connotations attached to mythology as a primitive religion, false scientific explanations of the natural world, and the general idea of untruth. Nonetheless, Alan Dundes (1997) refers to this as an “artificial myth” in the absence of a sacred cultural meaning. Star Wars fans may disagree about what is sacred.

These two new definitions for transmedia storytelling relate to the traditional definitions of mythology when transmedia storytelling is researched and practiced. I will review those other definitions below to contextualize my vocabulary for a storyscape with as much precision as possible. Subsequently, I will delve into one definition of mythology, the study of myths, where I will consider the foundation and structural study of myth to inform better the act of mythopoeia in a storyscape. This analysis defines the meaning construction and cultural resonance of these stories. The core models of mythic story construction, in the view of Campbell, Levi-Strauss, and Barthes, provide a method for authoring or understanding how mythic stories, and the ideas or intellectual conflicts

they contain, express themselves through the storyscape medium. First, I will briefly touch on the previous definitions of mythology, each of which also applies to storyscapes.

*The Merriam-Webster Dictionary* offers the following definitions:

1. “An allegorical narrative.”

According to this definition, storyscapes often aspire to be an allegorical narrative. How these allegories are constructed then leads us to the study of myth.

2. “A body of myths: as

a: the myths dealing with the gods, demigods, and legendary heroes of a particular people.”

This primarily refers to the bodies of myth such as Norse or Greek mythology that were created as the cultural expression of a people, often with religious qualities, usually in a distant or primitive past. This could apply to the contemporary mythology of the *Marvel Universe*. Significantly, these ancient collections of myth again form the basis of the storyscape content and story development.

“b: mythos 2 <cold war *mythology*>.”

This definition of mythology is not applicable to the storyscape, with the reservation that it may also serve as a topic for reinvention, or semiotic layering, in the storyscape mythology. That is because this definition is rooted in reality, and the storyscape is a fictional medium. The UFO mythology of Roswell and the US Air Force investigations were integrated and codified in the fictional mythology of the *X-Files* television series.

3. “A branch of knowledge that deals with myth.”

The study of myth is also not what is meant when the mythology of a storyscape is examined. However, this study often is the jumping off point of an act of mythopoeia, or myth-making. George Lucas cited Campbell as an influence. Moreover, the study of myth can yield insights into how to construct a mythology for a storyscape.

4. “A popular belief or assumption that has grown up around someone or something.”

This definition usually indicates a false myth or untruth. It contrasts the truth function of the myth to express an accurate view of the world with an understanding that over time what seemed true is now false.

One final need is to highlight the truth function in mythology before looking at the practical development of a storyscape mythology and the structural construction of myth-making in a storyscape. Historical myths often explained the natural world, as well as moral precepts, and were considered true. As time passed, and these explanations appeared wrong or simplistic, myths took on the mantle of untruth. For the purposes of a storyscape, I don't need to investigate science, myth, and how truth is expressed in a mythology. However, it is significant to note that the myth-making of a storyteller is with the goal of revealing the truth, or a meaning that has remained, at its core, consistent over time.

The practitioners in transmedia storytelling use the term *mythology* to define concrete attributes and information that is collected, usually into a bible, and represent artifacts and a method for designing a transmedia story. Creating a mythology is a transmedia production process. Secondly, writers and creators use the word *mythology* or *myth* to represent a work that aspires to be truthful, as opposed to a false myth, and becomes foundational in its cultural relevance. This foundational quality sets their

narrative aspirations within the context of the history of mythic stories as enduring tales that contain universal truths. The derivation or re-imagination of these semiotic themes and ideologies is a way of connecting to a tradition of storytelling that extends backward in history. For a creator, the more enduring a story, the greater validation it possesses. Shakespeare is the ideal. Finally, mythology can mean the proto-stories or conflicts, central to our cultural concerns that are expressed in a narrative form. For *Lost* that was science opposing religion, for *Star Wars* an updating of the hero's journey, and *The Terminator* expressed an ongoing anxiety with intelligent machines.

Jeff Gomez in an interview speaks to the process of creation concerning *Star Wars*: “What Lucas did went several steps beyond old-style character licensing and brand extensions. He created a unified body of work with an extensive backstory and mythology, and he determinedly guarded its canon while simultaneously opening up peripheral parts of his universe to exploration by other contributors” (Caranicas 2009).

In this section, I will describe the process of mythopoeia and creating a storyscape mythology as related to a storyscape. First is the mythological documentation of the storyscape and second is the myth-making process that determines the content of that documentation. As I noted before, the storyscape is an ecosystem, and this process is neither linear nor isolated from other variables. The creation of a mythology, the transmedia definition, as part of the story design process, precedes the implementation of artifacts but also evolves with their publication as they enter the canon. All canon, expressed through published works, becomes part of the mythology, so it continues to change as it emerges. To understand this mythological practice, I will start by examining the story bible that is used to document the mythology of a storyscape. Then I will delve

into the study of myth and mythopoeia and show how that is central to this design approach.

In particular, the model of four gestalts, with a mythopoeic story structure at the core, constitutes a design method that is significantly different from the methods centered on world-building and the so-called storyworld. The difference lies in the centrality of the mythic story. As I examine the story bible, and the creation of a storyscape mythology, I will emphasize how powerful, emotional story concepts are primary in the creation of that mythology. In discussing the storyscape mythology, writers often only consider the physical parts of the story across media, “such as characters, allies & enemies, fauna & flora, props, locations, chronology” (Dena 2009, 158). But as Dena goes on, “it also includes sections that are designed to facilitate consistent future production opportunities, such as the ‘Cosmology, Themes, Mythic Underpinnings’ and ‘Distant Mountains’ sections. As [Jeff] Gomez explained to me in a personal email communication on November 7, 2007: ‘The real magic in these products to me is in the cosmology section. This chapter is a true guide to the chemistry, message, and aspiration of the story world.’” In particular, in starting with the story bible, it is possible to mistake the trees for the forest, as the perimeter of the trees blocks our sight from the heart of the forest so too can the leafy detail of the production design notes obscure the important story roots. The view of this research is that the foundational story, in a storyscape that is encoded as myth-making, is the most important organizing principle for designing a storyscape. As Gomez (2010) elaborates:

It all starts with getting a clear understanding of the property at hand. Who is your hero? Who is the villain? What is this fictional universe trying to say? You need

to define the recurring themes, messages, and archetypes that guide the central narrative of your property and describe the vision of the original creator. Take Spider-Man, for example. At its heart, the property revolves around teen superhero Peter Parker and the guilt he harbors because he let his uncle's murderer get away. In short, it's a story about a kid looking to do good in the world to make up for his past sin.

In this example, the property revolves around the emotional heart, "a story about a kid trying to make up for his past sin." This is the story engine, or mythical constructions that resides at the center of storyscape design, rather than the world-building method. In particular, as I discuss the evolution and content of the storyscape mythology, it is important to bear in mind that all the elements of this mythology do not have equal weight. Most importantly, they do not contain deep and resonant meaning. In *Star Wars*, Luke's relationship with his father, Darth Vader, is more important as an Oedipal myth than the visual pleasures of Tatooine that are part of the set design.

Jeff Gomez is my principal example of a practitioner, as an instigator of the Producers Guild definition of a transmedia producer and the owner/principal creative director of Starlight Runner. He explains his methods to use the story, the way that is central to a mythic construction, and determines the storyscape mythology for properties. His practice leads to the insights derived from contemporary studies of mythology used in this analysis.

### **3.2.1 Mythology, the Story Bible, and Storyscape Practice**

Branded entertainment comes and goes in a flash, but transmedia storylines are timeless because they are built on a foundation of classic narrative structure. They're good stories.  
—Gomez, *Jeff Gomez*



The story bible has become a fundamental element of building a transmedia story—and a storyscape in particular. The story bible and its evolution as an ongoing document for canon and continuity is also referred to as the mythology. However, a story bible contains seeds of its confusion when the central part of this transmedia mythology documentation is the mythic/mythopoeic and character arcs that drive the story. I explore what is meant by transmedia mythology in this context, and as I noted previously, there is not a consistent definition. The same can be said about canon and where it lives in this practical methodology of creating a storyscape mythology. The work of Gomez’s company illustrates the industry’s muddled understanding of what constitute a transmedia mythology. One article states, “Starlight Runner Entertainment creates mythology behind movie franchises” (Fritz 2011).

The story bibles provide backstories, fictional histories, or rules that apply to supernatural powers or situations, all of which function as private supplemental texts used as a precursor to the writing of screenplays or books. It is a frequent exercise for screenwriters to write a character’s history up until the story starts so that the writer can better understand their motivations moving forward into the diegetic text. As television developed from an episodic model of self-contained stories to the complex form of continuing story arcs in the 1980s and 1990s, it became more salient to sketch out boundaries beyond the confines of the three-set sitcom. This new complexity led to pitch documents for television shows that described more of the stories and setting than was needed previously because the scope was larger than a single premise. The practice was codified into the evolving form of the “series bible,” which acted as a precursor to the bible of transmedia storytelling—a bible that attempts to cover all of the history, rules,

characters, and media instantiations of a project (or storyscape). The series bible was not originally a mythic document. Its purpose was to provide greater detail and depth to the story premises that would evolve along story arcs instead of repeating an episodic formula around a single premise in each episode. As a pitch tool, it also contained elements of setting or production design that were significant to the explication of the series appeal. As it evolved for more complex shows, this document became an informal reference for what had transpired in the series so as to retain consistency in new episodes. In the *Variety* article on transmedia storytelling, Caranicas (2009) says, “Transmedia takes the concept of the bible—a document containing backstory information that film and TV writers rely on for building plots and characters—to an extensive new level.”

The story bible for transmedia storytelling has evolved to mean the documentation of the mythology. Fritz (2011) points out, “In each case, *Starlight [Runner]* creates a ‘bible’ of 100 to 400 pages that lay out facets of the fictional universe, similar to those used for years on TV shows and comic book series.” Caranicas (2009) details, “*Starlight Runner* creates ‘megabibles and mythologies’ contained in oversized binders full of images, chronologies, storylines, character profiles and descriptions of such details as geography, vehicles and weapons.” This information contained in a story bible, or the memory of the showrunners (the people creatively in charge of the series), is the mythology of a storyscape.

The conception or practice of the story bible, or story bible and mythology documentation for large scale transmedia franchises, creates misdirection for designers and academics about the world-building method, where production design of the world seems primary but is not. It is the confusion and conflation of the term *mythology*

Caranicas (2009) references here when he discusses franchises and distinguishes the world from mythology, “studios create mythologies, multimedia worlds.” These mythologies are driven by a story at the heart. It is that story, conceived through the myth-making method of a storyscape, that is the most important element. Drawing attention to that crucial story conflict as the mythological engine that drives a storyscape, as it does with many narrative forms, Caranicas (2009) quotes Gomez: “The tool—transmedia storytelling—is capable of performing such feats as the recent revival of the Batman franchise. . . . The filmmakers were able to go back to the essentials—the true, deep conflict that the character faces—and they managed to make it resonant with our current conflicts as a society.” Thus, even in the story bible definition of mythology, it is the traditional story and character arcs that focus the materials for transmedia creation.

Returning to the series bible as a jumping off point for the transmedia mythology development, I want to examine the *Battlestar Galactica* series bible as a transitional example. It is transitional because it was an example of complex television and the seriality that stitched together the multiseason story and character arcs, and not initially conceived as transmedia. It is an advanced instance of a series bible that shares many aspects of the evolved transmedia “mythology” as an example of the documentation for a storyscape. It is important to note that the bible form is neither codified nor consistent. Subsequently, I will reference the role of the mythology coordinator for *Defiance*, the transmedia television show and synchronized participatory game world. This bible provides an example of how this document is started as a transmedia mythology. Below is the table of contents for the *Battlestar Galactica* series (Fig 11.), which illustrates the

categories of storyscape mythology documentation as well as the story-centric aspects that carry mythic structures including the myth-making and character arcs.

**TABLE OF CONTENTS**

Mission Statement.....	1
<b>The Twelve Colonies</b>	
History.....	4
Religion.....	5
Culture and Society.....	5
Technology.....	6
<hr/>	
The Cylons.....	8
Culture and Society.....	9
Technology.....	11
<hr/>	
<b>Character Biographies</b>	
Commander William Adama.....	12
President Laura Roslin.....	14
Captain Lee Adama.....	16
Lieutenant Kara Thrace.....	18
Colonel Saul Tigh.....	21
Doctor Gaius Baltar.....	23
Chief Galen Tyrol.....	25
Lieutenant Sharon Valerii.....	27
Number Six.....	29
<hr/>	
<b>Storylines</b>	
Tension.....	30
Structure.....	30
The Cylons.....	31
Plot-driven Stories.....	32
Character Stories.....	33
<hr/>	
<b>Season One</b>	
Story Arcs.....	34
Character Arcs.....	36
<hr/>	
<b>The Battlestar Galactica</b>	
History.....	41
Combat Operations.....	41
Flight Operations.....	43
CIC.....	45
Maneuvering Galactica.....	46
Damage Control.....	47
Enlisted and Officers.....	47

Figure 11 Battlestar Galactica Series Bible by Ronald D. Moore.

### 3.2.1.1 Story, Themes, Conflicts—The Mythic Engine

This table of contents of the series bible details the main story conflicts, story arcs, and character arcs and explicitly relates these narrative elements to the larger categories such as history, religion, and culture. This series evolved into a form of transmedia storytelling that does not constitute a prime exemplar of a storyscape because it was not originally conceived as a transmedia work, but for the purposes of understanding mythology, and a story-centric design method, this is a robust description of what could be described as an initial mythology. This bible was created in advance of the series. After the pilot, as shows were produced, they were added to the mythology, sometimes evolving or changing it.

The series bible begins by defining the central dramatic premise of the series: “it is the task of the series to maintain that tense environment and bring viewers back week after week to experience the thrills and cliff-hangers inherent in the story of a fugitive fleet on the run and one step away from destruction (Moore 2003, 1).” Ronald D. Moore (2003, 1), who wrote this document and was an executive producer on the show, goes on to say, there are three main story arcs at work,

1. Series Arcs
2. Multi-Episode Arcs
3. Episodic Arcs.

The Series Arcs run through the life of the show, dealing with long-term stories such as the Cylon pursuit of our fleet, while the Multi-Episode Arcs allow us to spend 2-4 episodes dealing with a specific crisis, say on one planet discovered by the Galactica, and the Episodic Arcs provide closed-end narratives for each show and giving any viewer a chance to watch this week’s episode. By employing this structure, we

gain the benefits of long-term story-telling, embroidering on the existing tensions and situations in the premise which have already hooked our audience and thereby delivering a richer and more compelling experience to the dedicated viewer, while at the same time making allowance for hooking the more casual viewer who may not be familiar with the long-term tales but is drawn into this week's episodic storyline.

More importantly, this document centers the material on the main stories, including the existential questions the Cylons face, the conflict of man and against machine, and various other story conflicts that drive the three arcs mentioned above. The series bible also demonstrates a conscious myth-making process by incorporating the twelve tribes, plus a lost thirteenth tribe, during their sojourn through a forbidding desert of stars to the promised land of their prophecy. These myths explicitly allude to both the biblical Hebrews and Moses and, by way of the original producer and creator, Glen A. Larson, Mormon mythology.

It is the story bible method of incorporating myth-making, the repurposing of mythological constructs in new semiotic configurations derived from previous meaning or mythic interpretation, that illustrates the story-driven and mythic explanations I discuss later. Those transmedia theorists who propose a storyworld or world-building method would value the various production design elements of this series bible as equal to the central conflicts and story arcs. Thus, for example, Jenkins (2006a) predicts, incorrectly, the increasing importance of the production designer in the transmedia storytelling production model. Also, the idea that mythology, described as all the elements discussed here, is to be included in the world-building model complicates a design approach. This is

because raising all backstory and production design to the same design level gives too much importance to elements of an imaginary world as opposed to the story and character. World-building yields a confusing and opaque model. This storyscape design method puts story and myth-making at the center of the mythology method and documentation, with character second and production design a much less significant concern.

### 3.2.1.2 Character and Biographies:

Who are the main characters in this storyscape and what is their backstory and major character conflicts? These often evoke classic roles including protagonist and antagonist, but also tragic flaws that drive character arcs. And how do they help us understand the story and core conflicts or exposit mythic situations? This is the initial cast in a storyscape that may ultimately consist of an extensive cast with multiple protagonists and antagonists. This story bible or mythology also includes both diegetic and nondiegetic characters. Nondiegetic characters are those characters who exist only in the mythology. They never appear in the works that are created, but they can determine the overall direction of the comprehensive story arc. The late exposition of the early history of the island in *Lost*—made explicit through a mythic conflict between brothers representing competing philosophies told in flashbacks—illustrates how this unseen mythopoeia was determining the interaction of characters in the show and illuminated core concepts of faith against reason. This is another central binary opposition that can be understood through a study of myth. When television mostly consisted of single-episode arcs, early story bibles often consisted of little more than character backstory, some settings, and style notes.

### 3.2.1.3 History, Technology, Culture, Geography:

Since a storyscape is most often an imaginary world, these are the details of settings and imaginary creatures that are needed to create continuity across the various shows or works. A bible also provides a wealth of suggested detail for production design and related design fields to use as the basis for their work and extended elaborations over time. These can be technical details that explain what is possible or impossible in the imaginary world; it is often an explanation of magical or advanced technological capabilities (not very distinct from magic). If the world-building method lives anywhere, it is here, as the details of the imaginary world are created. In the often fable-derived works discussed, this is often an ecology of fantastic or somehow supernatural creatures. Rules can be a “faster than light warp drive” or a determination that a spaceship can travel only near the speed of light (also not necessarily feasible but rules constrain the paradigm of the story). It may mean that a stake through the heart, or sunlight, or neither kills a vampire, but these rules and the physics of the universe regarding these devices and supernatural effects must be documented and maintained or risk audience confusion.

### 3.2.1.4 History and Canon:

The process of the story bible for a transmedia storyscape is to create an evolving document or conception of the whole project. Sometimes this mythology or bible is the conception in the showrunner’s head, who somehow manages to keep most of the details of the world straight because of his ongoing involvement. In other cases, the process involves adding the events and explanations that occur in the ongoing distribution of new



works to a central document. Updating only applies to canonical works, which are added as history within the story bible or mythology documentation. Science and magical rules can also evolve or be extended to new significant areas. In the original *Star Trek*, Spock often avoided death or injury through the exposition of new biological features, such as a second heart, two eyelids, or a method to carry his soul from one body to another. Thus, the mythology evolves in canonical details, though the authorial authority also determines what remains canonical, or historical over time. Vast swaths of the *Star Wars* universe that were canonical—important historical events, characters, and explanations—were recently disavowed by Disney, the new intellectual property owner, thus rendering moot anything that occurred in those books, shows, and games.

Before I summarize the mythopoeia gestalt of a storyscape and move into how the study of myth can contribute to understanding the myth-making core of a storyscape, I will adduce the example of *Defiance*. The website screenshot below (Fig. 12) illustrates



Figure 12 *Defiance* transmedia show and game. [www.syfy.com/defiance](http://www.syfy.com/defiance) 2015.

the interaction expected between the transmedia science-fiction show and synchronized online game through which participants interact. The events of the game affect the television series and characters from the series extend into the game. The author/creators of *Defiance* adopted the mythology term used here and grappled with how this mythological method evolved in practice across the two media. In this case, they were often focused on the canonical aspect of the mythology, the need to maintain continuity in an imaginary world that is constantly in a state of creation and evolution. The showrunner, Kevin Murphy (2013) discusses the mythology methods and process in an interview with *Indiewire* and points out the need to maintain a central authorial focus: “We all had big bibles at the beginning but no one was keeping them up to date, so they became useless because there are a million new ideas happening.” Murphy goes on to say that they ended up hiring a mythology coordinator, a new storytelling role, “Our mythology coordinator . . . takes the point on that. . . . He sort of fell into the idea of helping us keep the mythology straight” (Murphy 2013). He goes on to say that: “We are getting very complex with a lot of our mythology material as far as documents released on Tumblr. We have a mythology coordinator and I go through him, and Bill and Nick from the game vet everything” (Murphy 2013). This underscores the importance of keeping the mythology consistent to maintain continuity and provide fewer barriers to immersion because contradictory information draws attention to the story medium. It also consolidates the mythopoeia, the characters, the history, the published works, and the physical characteristics of the elements in an encyclopedic concept that is expressed as the mythology of the storyscape.

Returning to the two new definitions of mythology (mythology as story bible/archive and mythopoeia) related to a storyscape, the mythology coordinator is responsible for the documentation of all the referenced elements of the evolving storyscape in terms of the story and character arcs, history, rules, details, and the evolving canonical history as it occurs or is expunged. Secondly, he documents the core myth-making, as it is extended or refined, in the service of one or more central story ideas. The *X-Files* mythology is a good example of how the central idea of “Believe, the truth is out there” creates an exposition of science and technology whose main appeal often lies in the coherence of the myth-making explanatory powers. In the driving conflict between the protagonists, Scully’s skepticism and Mulder’s belief uncover a core mythology of linked supernatural events that build a logical model. This mythology explains government cover-ups and flashpoints between skeptics and believers of alien phenomena such as the Roswell incident.

From a game and virtual world perspective, Klastrup and Tosca (2004, 3) in their essay on transmedial worlds and cyberworld design posit an approach that they define in opposition to Ryan’s narrative across media approach. However, they put a foundational story at the center, and their categories underline the “meaning-centric or story-centric point of view.” They further acknowledge “that in studying particular actualizations of a transmedial work, it can be fruitful to look at how this particular actualization produces new meaning-bearing content—content which can then be reproduced or reused in forthcoming actualizations of the world” (Klastrup and Tosca 2004, 4). This meaning-making structure is what defines the mythopoeic center of a storyscape, as they note: “A transmedial world shares a basic foundational story, and there is only one acceptable

version of an ethos, topos and mythos (Klastrup and Tosca 2004, 2).” They divide a transmedial world into these categories:

Mythos: the establishing conflicts and battles of the world, which also present the characters of the world. The mythos also includes stories of or rumours about certain lore items and creatures which are unique to the world.

Topos: the setting of the world in a specific historical period and detailed geography. . . . From the player’s perspective, we can say that knowing the topos is knowing *what is to be expected from the physics of and navigation in the world*.

Ethos: this is the explicit and implicit ethics of the world and (moral) codex of behaviour, which characters in the world are supposed to follow. Thus ethos is the form of knowledge required in order to know *how to behave* in the world.

(Klastrup and Tosca 2004, 4)

This approach maps to the story bible categories; however, it specifically devalues the primacy of story conflicts, character arcs, and themes in the creation of the world because it highlights the mechanics of world-building. This is despite so many elements that are noted, such as mythos as the establishing conflicts of a world, or ethos as explicit ethics, to be drivers of a story or narrative approach. However, in the context of game development or virtual world, these categories become a good checklist of elements that overlap and can invoke the semiotic relations, in the gestalts of the storyscape. Their argument for a world-building approach, they acknowledge, contains a strong story and narrative focus, despite a model that premises a transmedial world that is not a story-world. Their concept was the original storyworld, called a transmedial world, without a need for story as a primary component to model a grouping of works in a shared world.

In contrast, Lars Konzack (2006), in a paper on the subcreation of secondary game worlds, explicitly discusses Tolkien's term *subcreation* as a mythical method to design game worlds. This method draws from the second definition of mythology, mythopoeia, applied to a storyscape, which is the conscious creation of mythic stories. In the aesthetic he describes, he proposes this as a space-based poetics as opposed to a time-based poetics, as applied to game worlds that are secondary worlds. Secondary worlds can be equated with the imaginary worlds of Mark Wolf, whereas the primary world is the "real world." His categories are similar to Klastrup and Tosca, but he puts myth-making at the center of this model. "Firstly (Cosmological level), the subcreator strategically must construct carefully prepared mythologies, religions, and philosophies of the world, secondly (Epic level), the subcreator tactically has to construct a secondary world with geography and items based on the cultures, mythologies, religions, and philosophies, shaping the world historically. And thirdly (Naïve level), the subcreator operationally builds within his subcreation what seem to be simple narratives that are easy to grasp for the explorers of the secondary world" (Konzack, L. 2006, 4).

The two approaches of Klastrup and Tosca and Konzack appear very similar and apply to the story bible example of mythology. As a whole, these elements map closely to the first mythology definition—the documentation of all of these elements in a storyscape. These elements, in my story approach, are configured along the lines of Konzack's point of view that this is a mythic construction with a foundational story at the center.

"Examples of franchises that have been hurt by the lack of an adequate mythology, or enforcement of a mythology, are legion, Gomez says" (Caranicas 2009),

and this points to the primacy of mythology in our approach. Caranicas (2009), in his article on the transmedia franchise phenomena, mentions that a “Hollywood talent agent who works in new media says his clients ‘who own a piece of intellectual property that will be replicated on different platforms need to be intimately involved in extending that mythology’ to preserve the property’s integrity.” However, this is not simply the technology of a spaceship, the powers of a wizard, or the six-legged horse; it is the story and resonant meaning that is expressed in the storyscape through a myth-making process. Gomez underlines again: “They can’t just let anybody do it,” he says. “It may not be just fanboys who are going to see a film like *Spider-Man*, but those fanboys become your evangelists if you pay close attention to the mythology and make sure it sticks to the original thrust of the story. If you don’t, you can have problems” (Caranicas 2009). I interpret this as focus on the myth-making core of the mythology, the central story that animates a work in one or many media, and the core of the story that is a form of meaning creation through the reconfiguring of concepts and ideology at the core of these ideas. However, it also illustrates the confusion as the term *mythology* for transmedia authoring is used in practice and scholarship, in many new and old ways, and with different or multiple shadings.

In the storyscape method of the four gestalts, mythopoeia, myth-making, forms the primary method to author a story across media. The myth-making results in a specific mythology, a collection of stories included in the transmedia mythology archive/story bible. This mythology archive also contains character and canon—two additional gestalts I separate out because they work powerfully on their own. The complexity of this interaction again points out the flaw of the world-building method that includes all the

elements of the story bible as components of the storyworld. The mythopoeic/myth-making gestalt consists of the central stories, cultural oppositions, and reimagined historical myths as well as the details that determine the unfolding events and the supernatural physical aspects of the imaginary world. This gestalt is scaffolding that allows the authors and participants to construct a whole storyscape in their mind and memory. At the heart of this whole is the story and this story derives from culturally relevant or historical myths, or perhaps equally significantly, can be constructed as a modern myth. Accepting myth-making as a central organizing principle and gestalt leads to one of the other definitions of mythology, the study of myth as an analytical method to understand how myth works in the storyscape.

### **3.2.2 The Study of Mythology Applied to the Mythopoeia of the Storyscape**

In this section on mythology and the academic theorists in the field of transmedia, the focus is on how the study of mythology is invoked both explicitly and implicitly to define the content and structure of the narrative structure as it applies to transmedia. The use of the term *mythology*, as expressed by the following theorists, derives from the definitions that I previewed previously. The term *mythology* is part of the vocabulary of the community of practice but is used in general or nonspecific ways in that context too. Some use mythology to refer to Levi-Strauss and the binary opposition of myth as a thematic and cultural conflict, others to the semiotic principles of mythic construction and ideological underpinnings, and many to a general understanding of the study of myth evoked by Joseph Campbell (1968) as a model or expression of cultural concerns. Others lack any particular specificity but address myths as a description of universal truths in opposition to the definition of myth as a false explanation or understanding. In this

section, the goal is to examine the discussion of myth and myth-making by transmedia scholars, often similar to the proposed definitions above, but applicable to designing or understanding transmedia storytelling. While myth and myth-making are of significant concern for transmedia theorists, they are not often invoked as design or organizing principles to understand transmedia storytelling. Often when it is in use, it is as a subcategory of the storyworld or world-building, as noted previously.

In making the case in *Convergence Culture* for myth-making in movies, and in transmedia practice, in particular, Jenkins (2006a, 120) flatly states: “The idea that contemporary Hollywood draws on ancient myth structures has become common wisdom among the current generation of filmmakers.” And Long (2007, 16) quotes Hanson, who points to central mythic themes as providing resonant structures, “I believe the condition of screen bleed is proliferating due to the immersive 3D worlds we explore as game players and digital media consumers. This is why all-encompassing mythologies are the most resonant with contemporary audiences (Hanson 47).” Jenkins (2006a, 119) himself invokes Tolkien’s mythopoeia as central to this transmedia method, “writers such as J. R. R. Tolkien sought to create new fictions that self consciously imitated the organization of folklore or mythology, creating an interlocking set of stories that together flesh out the world of Middle Earth.” The storyscape model, drawn from ancient religions and truth structures, then remediated in the transmedia mythopoetic model, finally achieves a flowering as cultural, or subcultural, model, a mythic story. It’s capable of speaking to the deeper concerns of a cultural group by choosing relevant and resonant core stories.

These transmedia scholars reference the contemporary study of mythology, embodied by Campbell’s views, where myth embedded in popular cultural artifacts such



as books and movies speak to our anxieties and concerns. As the earlier myths were about hunting in a hunter/gathering culture or subsequent myths revolved around the planting of the seed, nature, and appealed to the agrarian societies, so these stories speak to contemporary concerns with our relationship to religion, or science, or thinking machines. Jenkins (2006a, 121) analyzes transmedia stories and points out, “*The Matrix* is a work very much of the moment, speaking to contemporary anxieties about technology and bureaucracy, feeding on current notions of multiculturalism and tapping recent models of resistance.” This mythic story engine is precisely the model Campbell considers when he proposes that movies are the twentieth-century mythology, and storytellers have happily assumed the mantle of mythmakers as a synonym for a storyscape storyteller. “These new ‘mythologies,’ if we can call them that, are emerging in the context of an increasingly fragmented and multicultural society” (Jenkins 2006a, 121). It is helpful to see storyscapes as representing cultural groups’ world-views and contemporary concerns. Of course, as humans, some of our central concerns—father, mother, sister, and brother—still retain a mythic narrative of basic human truths, though perhaps with a modern twist. This mythology also acts as a cultural and ideological landmark that attracts like-minded members of a group and defines shared points of view and values.

Indeed, *The Matrix*, *Lost*, and *Star Wars* all borrow substantially from past myths reinterpreting and updating to find contemporary resonance. These myths may be stories or themes, sometimes allusions that become backstories or characters and archetypes. Even on the surface Jenkins (2006a, 120) concludes, “We can see *The Matrix* as borrowing these archetypes both from popular entertainment genres (the hacker

protagonist, the underground resistance movement, the mysterious men in black) as well as from mythological sources (Morpheus, Persephone, The Oracle).”

Significantly, the mixture of archetypes is drawn from ancient and new; contemporary mythology includes the urban myth of the “Men in Black” who destroy evidence of alien encounters. The “Men in Black” myth explains why evidence of alien presence is lacking but codifies the government role as an iconic representation. The *Godzilla* movies reify contemporary nuclear anxiety in a monster to be subdued by science and government. These stories combine old and new myths and connect us culturally to past works, infusing them with new meaning. Even when the origin is unknown to the audience, the grammar of this storytelling inherits the history of these elements, rooted in mythology, as the building blocks of new stories. As Jenkins (2006a, 122) notes, “even if you see classical myths as more valuable than their contemporary counterpart, works such as *The Matrix* draw consumers back to those older works, giving them new currency.” These mythical references are particularly relevant in the digital storyscape where drillability and encyclopedic pleasures encourage a robust exploration of the most arcane details and relationships. *Lost* and *Star Wars* both created fan cultures that explored these topics. This reimagining may drive the participant to compare or review the mythic antecedents. Or the new myth construction, realigned with contemporary points of view, may find a renewed relevance in the way we use stories to explain our world, derive meaning, and connect with like-minded individuals.

*The Matrix* embraces one salient contemporary anxiety, man against machine. From the nineteenth century and in movies since *Metropolis*, thinking machines contested with humans for dominance. This concern is subject to rational debate in our culture but

mythically is resolved on a cathartic or emotional level. As Geoffrey Long (2007) points out, “the story of the *Matrix* films is the story of Neo, yes; the story of the *Matrix* franchise, however, is the story of the fall of humanity, the rise of the machines, and their continual conflict. The story of the *franchise* is the story of the *world*.” Thus, these mythic constructions provide both a story conflict, which extends across media and a thematic concern that is intrinsic to the participants. This is further discussed in the definition of mythology for transmedia storytelling to follow, but the point is that this medium, the storyscape, is viewed as having many mythological attributes in transmedia scholarship. It is often viewed as the narrative goal of the endeavor: to be a myth-maker, to create a mythology, to define archetypes, and to make stories of such power and resonance that they provide an explanatory model and usefulness to their cultural group.

Also, it is important to remember as Derek Johnson (2014) tells us that “most crucially, culture and mythology have been reconceived as proprietary, manageable property.” This may sound cynical but is important to understand that the storyscape in these examples, often a vast ecology, has cultural, economic, identity, ideological, and religious dimensions that are extensive. The creation of these resonant stories takes place under the conditions of intellectual property law, competing creative authority, and participatory audience interactions. Nonetheless, I argue it is their meaningfulness that carries the storyscape forward more than the pleasures of the medium that arise from the affordances discussed previously. The following section explores how the study of myth can give the storyscape myth-making method a structure that can be explicit, as plot or mythic structures, or invoked, in other related media where plot may not exist and story enters as a semiotic referent. Myth-making, character, canon, and genre act as landmarks

created partly from the authorial top-down design and also as a bottom-up authorial contribution of the audience through the multiple participatory interactions that form the storyscape.

### **3.2.3 Mythopoeia in the Storyscape**

Mythopoeia in the context of a storyscape defines the symbols, cultural landmarks, and conflicts, as well as the natural and supernatural rules of the stories. By this definition, some contemporary stories function as myths. By incorporating the mythopoeia gestalt in their design vocabulary, transmedia designers will come to appreciate the importance of dramatic oppositions, such as religion against science or love contesting with duty, as a unifying method for their storyscapes. The myth-making gestalt defines the rules of the universe and the major characters that participate in founding myths (illustrative stories that define central themes or conflicts). Further, it weaves into the worldview symbols that are significant to the structure of meaning in the story. For *The Ghost Club*, it is investigations by Houdini and Sir Arthur Conan Doyle (two main characters) and the conflict between skeptics and believers. Our storyscape mythology draws from current transmedia storytelling practice and refers to the power of contemporary and ancient myths defined by Joseph Campbell (1968).

Myth-making is the key to the storyscape transmedia storytelling approach because the core conflicts and ideals that are designed provide the engine for the diverse experiences across media. This is in contrast to theorists and practitioners who put the primary emphasis on the creation of a storyworld or world-building. In this gestalt method, a resonant mythology such as the Jedi Knight and the Force (from *Star Wars*) can animate the integration of meaning across disparate media with different affordances.

More significantly this approach posits a relationship between works that is not verbal, logical, or plot oriented but instead acts as a gestalt for the participant to conceive a whole work. This mythopoeia connects works without distributing clues and plot points. In media where the mythology isn't invoked, then symbols and other connectors represent it to make an integrated experience.

The central mythopoeic design paradigm that I employ draws from Levi-Strauss (1983a) and Campbell (1968) in identifying a binary opposition that troubles cognitive or cultural models and creates a resolution through the story's explication and synthesis. In Levi-Strauss (1983b) this forms a binary opposition, such as the "Raw and the Cooked" that extend through early cultural mythologies. In contemporary times we are not so concerned with uncooked food but themes, such as love vs. duty, are considered the driver of modern stories, such as when soldier is forced to choose between wife and service to the country through the military. *Lost*, the TV series, was partly designed to express the conflict of science vs. religion, with many characters adopting names and postures that highlighted that conflict. *Lost* followed this theme to the conclusion, when the series resolved around a supernatural, overtly religious conclusion that left the more scientifically inclined participants complaining loudly about unresolved scientific mysteries while faith united the characters in multi-religious afterlife.

In this design approach, myth-making is expressed through primary binary oppositions, stories that are referenced or told within the narrative that are symbolic parallels to the meaning of the story, and symbols that contain these meanings as a form of mythological shorthand for the central premise. In the *Ghost Club* storyscape, a core opposition of skeptics and believers was employed, but at an existential level the ghost

genre is powered by a narrative desire to understand the boundaries of life and death.

### 3.3 A Summary of Myth and Mythology in a Storyscape

There are and remain two aspects of myth: one is its story-structure, which attaches it to literature, the other is its social function as concerned knowledge, what it is important for a society to know.

—Northrop Frye, *The Great Code*

Myth is the central gestalt that unifies a storyscape. This mythology is comprised of two new storyscape definitions. Briefly, the first is comprised of the transmedia documentation and its components as outlined, and secondly mythopoeia, the act of myth-making. My story and narrative approach points to this myth-making, grounded in historical mythology, imaginary worlds, and fable, as a story thought process that can be analyzed using the study of myth to give us clues to the structure and meaning of stories that are resonant in our culture.

Thus, as outlined above, models of stories by Campbell, such as the hero's journey, can help connect disparate media in a cognitive web of narrative meaning. Understanding the binary opposition of myth, and the conflict and resolution of stories can explain the core story design methods for a storyscape. The resolution of these conflicts in specific media and across media creates suspense and participation by an audience. In a semiotic analysis, the history of signs and meaning, often embedded in contemporary or derived from historic mythologies, also enlighten a story method based on mythopoeia.

As Northrop Frye (2006, 55) remarks above, myth is a story structure, but it is also a cultural force, “social function as concerned knowledge, what it is important for a society to know,”—encoding major ideologies and themes, cultural anxiety, and an attempt to find truth and an accurate model of the world in the chaos of information and

data points. Understanding that storyscapes, by design, are encoding this cultural information or conflicts in mythic models provides insight into a new medium with an evolving aesthetics. Binary oppositions, leading to a resolution, take on new meaning in an open work as described by Eco. Nonetheless, understanding the wider mythic structure and applying it to a storyscape may engender a meta-catharsis (a more resonant or robust catharsis) or something approaching the meta-catharsis that Tolkien (1966, 87) proposed as a eucatastrophe, “the joy of the happy ending: or more correctly of the good catastrophe, the sudden joyous ‘turn’ (for there is no true end to any fairy-tale): this joy, which is one of the things which fairy-stories can produce supremely well, is not essentially ‘escapist,’ nor ‘fugitive.’” In Tolkien’s analogy, the Bible’s many mythic or fairy-tale-like stories point to a eucatastrophe that unites the work.

### **3.4 Character, Canon, and Genre**

In the previous discussion and the multiple definitions of mythology, there is an overlap of these expositions with the categories of character, canon, and genre. In myth-making, character and conflict are often wrapped up together as mythical characters become explicit referents for other mythical stories and conflicts. In the documentation of a storyscape mythology, canon explicitly becomes part of the mythology documentation when it is considered authorized. The four gestalts come together in the storyscape and combine to form a whole, summing the storyscape. Nonetheless, all three contribute separately as gestalts needed to unite the whole and as separate design considerations of a storyscape.

#### **3.4.1 Character**

Character occupies a central role in storytelling, as articulated originally by Aristotle. Serialization and complex television shows with long-term arcs have focused attention on how characters can provide an organizing principle for serialized and expanded transmedia artifacts, where character can function as a dramatic organizing force in stories and games and, therefore, become a major gestalt across media.

Character can work as a transmedia design element in three ways. There are embodied characters that are expressed as actors, abstract characters that represent the spirit of the character but not the specifics in look or history, and the archetypal character that represents the rudimentary features of that social archetype. Scott McCloud (1994) has explored levels of character abstraction that are represented in comics from abstract to photographic, while scholars including Elizabeth Jane Evans (2007) have asserted the value of using character in different related narrative contexts and with various forms of dramatic agency as a crucial design element for transmedia storytelling.

Most transmedia and media theorists acknowledge character as one primary element of a storyworld and in transmedia examples. Character is a sizeable component in the storyscape mythology, both for myth-making and backstory mythology. Moving forward as characters' actions, history, and motivations are revealed in the diegetic texts, it is documented in the mythology as canon that unfolds through the storyscape artifacts. I disagree with most theorists' perspective on how character interacts with the storyworld or world-building model. However, the importance of characters in transmedia is often highlighted, if sometimes given short shrift. Ryan (2012, 380) states: "Yet a storyworld cannot acquire a distinctive identity without characters who inhabit it, and characters cannot acquire an identity without some kind of personal history that follows them



around” and Long (2007, 45) points out, “Transmedia narratives, however, are indicative of a new shift in emphasis. The entertainment industry has learned that popular recurring characters can increase repeat revenue and that a rich story world that can host multiple sets of recurring characters, as in *Star Trek* and *Star Wars*.” Both point to the centrality of characters in designing and conceiving these storyscapes. In *Lost* and the *Battlestar Galactica* series bibles, characters provide a long-term organizing principle. In *Lost*, as I will further explore as an example, this extends into the storyscape artifacts and also forms an orientation for an audience that has an interpersonal focus.

In her analysis of *Spooks* and audience agency, character, and transmedia drama, Evans (2008, 213) concludes, “as such the further development of forms and technologies with differing levels of interactivity into coherent, trans-media texts, will require a greater understanding of the desire of audiences to transfer forms of engagement available through television texts into those platforms that seem to offer new ones.” This engagement is how character ties together transmedia through viewing and participating in multiple media works. The participant creates a mental gestalt of the character, and the various incarnations of that idea across media, to develop an overall gestalt that can provide structure for a story. Certainly, character is not a new organizing principle for drama, but with a storyscape, character is encountered across media and modalities, imaginary and embodied, so as to provide another unifying design gestalt. This view restores character to a central place in this story model, as opposed to the world, as maintained by most other theorists. The characters drive the storyworld and not the other way around. The following chart (Fig. 13) shows how an audience follows the characters and their interactions across the vast serialized stories of the *Lord of the Rings*

and other movies.

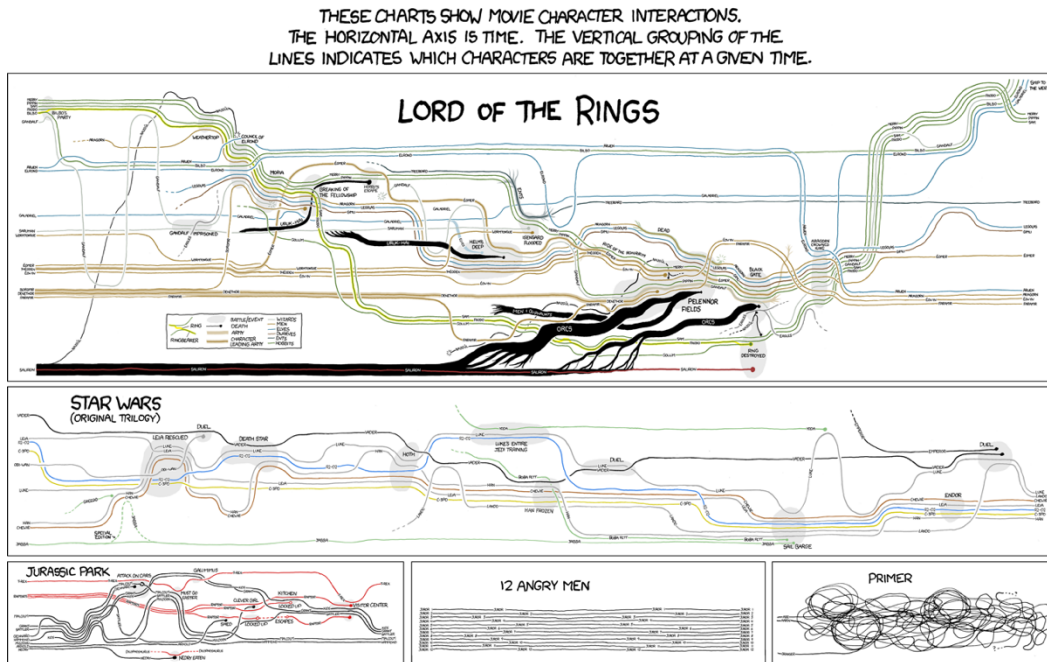

Figure 13 Movie narrative charts. Randall Munroe XKCD [www.xkcd.com/http://xkcd.com/657/](http://xkcd.com/657/)

My three classifications of character—embodied, abstract, and archetypal—are ways to represent a connection between different media. These categories are drawn from theory and practice, as discussed previously, but particularly from the practical craft of screenwriting expressed in embodied performance, to the critical discussion of digital media characters’ depiction, and extending into the abstract characterizations that have been discussed in comics and animation (McCloud 1994). Some media, such as games, have difficulty representing embodied characters. It is hard to wholly represent a named flesh and blood actor in games because of logistic reasons that include the difficulty in recreating an actor’s voice or likeness and cost of licensing. A game may require a more abstract representation of a character in order to more easily create a first-person experience. The optimal connector of character would be to present the same embodied

character across media for the sake of continuity of meaning and representation but each medium has a different character representation system. In the *Ghost Club* storyscape, some of the same characters are present in the movie and webisodes but abstract and archetypal examples exist in the other media artifacts (see Chapter 5).

Creating abstract characters is a way to intrinsically reference a central story within a storyscape by referring to other representations from other media and adopting relevant characteristics. Games can use characters that are loose abstractions: cartoonish figures with some physical similarities or identifying prop but not meant to represent the embodied character. The *Lost* video game had characters that resembled actors from the show but were abstracted and unnamed. Since these abstract characters refer to the embodied role or role/archetype but are not explicit, this allows for a player to inhabit an avatar as himself or project other interpretations on how this character acts. Defining role is another technique of abstraction that can connect distinct media. In the *Ghost Club* storyscape augmented reality game, you adopt a role coequal with characters from the movie and the mythology: Jr. or Sr. Technician, Psychic, or Archivist.

Archetypal characters represent the fundamental aspects such as hero, villain, healer, mystic, and scholar that correspond to the larger story schema represented in the storyscape and transmedia bible. As Konzack (2006, 6) puts it, “One mythical method used in digital games has been that of the Jungian Archetypes. The story goes that George Lucas used *The Hero with a Thousand Faces* by Joseph Campbell based on Jungian archetypes when creating the story of *Star Wars* back in the 1970s.” If a story revolves around a conflict between science and religion, then a priest and a scientist may connect the elements across media in a way to allow the user to perceive the combined

participatory elements.

When Stephen King interviewed the showrunners of *Lost*, they compared the show's characters to King's archetypes in his book *The Stand*: "Lindelof: His entire character sort of is constructed around that. The thing about *The Stand* is that there are all the archetypes, and we embraced the same thing. The strong, silent, heroic type. The nerdy guy. The techie. The pregnant girl. All those characters exist in *The Stand*, too" (Lindelof and Abrams 2006). Some archetypes lead us back to Propp and mythology; others represent contemporary archetypes such as the hacker. The *Battlestar Galactica* story bible sets out the principle that characters in the show are real and not archetypes, but it still creates a storyscape archetype that can be extended across media as an archetypal character of its own. By this, I mean an instantiation in a different medium where the character's salient physical, historical, or dramatic conflicts can be incorporated. In a virtual world or ARG, a participant can inhabit a character that has that exposition or is confronted by dramatic conflict that invokes that archetype, and still be a layer of character that connects media.

Character acts as a gestalt that provides a narrative thread across media in a storyscape. It constructs a mental model across the different media modalities by connecting the embodied, abstract, and archetypal. It also speaks to the subjective experience of stories that is part of a storyscape, where the subjective pleasures of engagement are experienced individually as movie watchers, game players, puzzle solvers, or shippers.

### **3.4.2 Canon**

In a storyscape, the term *canon* refers to the approved, official media elements of a fictional universe, based on intellectual property rights, or to some form of consensual agreement on an authorial authority by fans and participating communities. Canon defines the events that have occurred inside and outside of the fictional world that comprise the history of that universe. Since there are multiple media elements in a storyscape, it is important to have a consolidated history and cosmology to reference (Long 2007; Jenkins 2007b; Gomez 2010). Canon is often used to describe the boundaries of official elements of the *Star Trek* and *Star Wars* media franchises as a way of reconciling contradictory storylines. Lindelof and Cuse, the showrunners of *Lost*, often explicitly labeled some transmedia stories such as *The Lost Experience* as canonical or noncanonical (I. Askwith et al. 2007).

Canon, narrative cohesion, and continuity are three words often grouped together in the discussion of canon and its value to a transmedia story. As stories are told across media, consistency seems self-evident as a design method, but must be understood in the context of its primacy in a storyscape and problems of canon across media. In the storyscape method, canon functions as a gestalt, enabling the disparate parts of the storyscape to form a unified whole. In this method, canon is inferred in media where it is not explicitly referenced. In a gestalt, the parts that contradict the overall image or model must be ignored to conceive of the whole. The more cohesive and continuous a model, the easier it is to conceive and extend the storyscape conception by a participant.

In a key early blog post, Jenkins (2009b) addressed continuity and coherence, as a significant consideration in designing a transmedia story: “It is certainly the case that many transmedia franchises do indeed seek to construct a very strong sense of

‘continuity’ which contributes to our appreciation of the ‘coherence’ and ‘plausibility’ of their fictional worlds and that many hardcore fans see this kind of ‘continuity’ as the real payoff for their investment of time and energy in collecting the scattered bits and assembling them into a meaningful whole.” This “meaningful whole” is designing for the storyscape canon gestalt. Long (2007) extends Jenkins argument explicitly to define canon as central to transmedia storytelling franchise practice, “Canon and continuity are key—while strict continuity may feel constrictive, wantonly breaking these things is as dangerous as misrepresenting a recurring character. Audiences may have their suspension of disbelief shattered, which then lessens their investment in the narrative franchise.” As Bordwell and Thompson (2010) pointed out, in arguing against the transmedia storytelling medium, comprehension is weakened across inconsistent stories. In contrast to Bordwell and Thompson, Long (2007) proposes canon as way of defining and evaluating the medium and declares, “I’d like to refine Jenkins’s definition by suggesting that transmedia narratives can be evaluated by how well they set themselves apart from transmedia branding through *narrative cohesion* and *canon*.” Thus for a storyscape, the qualities that follow from canon—continuity, narrative cohesion, and consistency—are part of a design process that encourages engagement and involvement with the story through coherent exploration and investigation by participants across media. Canon can include immersion, through theme parks or alternate reality games, for example, and other foundational story qualities such as the backstory of a character or mythic oppositions.

Murray argues that *Lost* failed in some of the ways that canon was implemented. For her, “*Lost* also exemplified an important design challenge for ‘transmedia’ in the

dissatisfaction fans expressed at the poor imitation of the original cast in the videogame, and confusions it created over which nonbroadcast story elements were ‘canonical’ and part of the central storyworld and which were just throw-away riffs on similar situations” (Murray 2012, 2). Murray touches elegantly here on unifying gestalts: canon and character. In much the same way as Long describes the usefulness of consistency of canon, Murray underlines this consistency as a heuristic principle to consider for these gestalts. She further suggests that the extension of characters and their various abstractions across media can be effective as aesthetic elements.

Long (2007, 40) makes the consideration of canon at the beginning of a transmedia narrative as a significant design consideration that can define the medium: “This is where a crucial distinction can be made concerning true transmedia narratives like *The Matrix*, and can be considered a first step toward establishing an aesthetics of transmedia storytelling: each component of a transmedia story is designed as canonical from the outset.” Thus a storyscape, because it is considering canon from the outset, is a transmedia narrative in the franchise model by this definition, and in this design model, Long’s transmedia aesthetic, with a centrality of canon, becomes one of the four design gestalts of this method. As Long (2007, 40) and others have argued, participants who have a consistent model of the story and related events will have a “fuller understanding and a better experience of the world as a whole.” In this quote, I would replace *the world* with *the story* or *the storyscape* because the resonance he refers to is not the pleasure of experiencing the world but the coherence and impact of the story, just as Bordwell and Thompson argue the opposite, that lack of coherence diminishes the story.

Before discussing canon's imperfections and problems as an aesthetic in a storyscape, I will touch upon canon as a practical method, and the integration of canon into mythology documentation or myth-making. As noted previously, the mythology documentation includes canon in the form of media elements that are acknowledged as "canonical" insofar as an authorial authority includes them as such. Typically these are artifacts sanctioned by the intellectual property owner and usually consist of movies, television shows, webisodes, books, comics, and games. Canon exposition is reflected in the publication of these works and codified through formal and informal methods. In some projects a single person, showrunner, or writer keeps a running history in their head, and they are referred to as a "human bible" or "walking bibles" (Dena 2009). This canon extends from the scripts, as expressed in the media, the story as it unfolds, the characters explanations and motivations expressed through action and dialogue, and the physical aspects and laws expressed. This canon extends down into the continuity of the smallest details. In the case of, the mythology coordinator maintains the canon as part of the mythology documentation in a wiki. Kevin Murphy (2013) explains that the *Defiance* mythology coordinator maintains the canon as part of the mythology documentation through "an ongoing wiki, which allows anyone on the production staff, the costume department, and the game side to instantly get access to all of the show's designs and designs for the game."

In practice, storyscape canon becomes storyscape mythology when it is published and documented. The series bible is a pre-canon before it is reified through media products, and may change if not expressed literally in those works. In most instances, pre-canon is implemented early in the storyscape process as a form of story and character



exposition; however, there are elements of the character, story, or physics of the storyscape that are conceived one way and evolve through their expression. For large storyscapes, such as *Star Wars* or the *Marvel Universe*, managing this coherence and continuity, the canon, across time and media, requires increasing attention and resources to maintain. Among the early *Star Wars* novels was one that had a romantic relationship between the brother and sister characters, Luke and Leia, because that portion of the story was not coordinated. In practice, this process is even more complicated. Canon is not immutable, and there are different types of canon that make up a storyscape. Since canon works both as a gestalt unifying the whole and as an aesthetic that increases involvement and audience pleasure, it is important to review how canon in a storyscape may map inconsistently to the ideal aesthetic of consistency and narrative cohesion.

### **3.4.3 Canon, Non-Canon, Fanon, and Multiplicity**

By paying close attention to staying in canon, building an open world, maintaining a consistent tone across extensions, carefully deciding when to begin building a transmedia franchise, addressing open questions while posing new ones, and looking for ways to help audiences keep track of how each extension relates to each other, transmedia storytellers can weave complex narratives that will prove rewarding to audiences, academics and producers alike.

—Long, “Transmedia Storytelling : Business, Aesthetics and Production at the Jim Henson Company”

As Long (2007) indicates above, paying close attention to canon can prove rewarding for the reasons outlined previously and for all participants. Nonetheless, the ideal and reality often diverge. Part of a storyscape is noncanonical, existing outside of what is authorized or accepted. Jenkins (2006b) and other media theorists have written about fanon, canon determined by fans rather than a central intellectual property authority, and what exists outside canon, such as fan fiction. Fanon is a paramount medium of transmedia storytelling because of the participation of the users in creating

their own related stories, paratexts, and experiences. The canon gestalt reaffirms links to the canonical works in the storyscape, to maintain consistency across the fictional universe. The body of canon maps to the storyscape as the boundaries of a single unified story, but the storyscape as a whole, a mental model or gestalt, extends beyond any authorial approval. Further, canon is subject to the whims of the intellectual property owners, and the negotiation of canon and a comprehension of the whole storyscape are subject to a process of negotiation and design.

Ryan (2012) captured nicely the canonical relationships of the *Star Wars* universe in a diagram, in which the red lines outline the six movies as comprising a core canon from which all other works are derived (see Fig. 14). She includes the *Star Wars* expanded universe (EU) as licensed works, approved by an authorial authority (authorized), that overlap but extend in some ways beyond the known canon of the six movies. The implication is that these works in different media are extending the authorized canon—note the brown dotted line—to online games, video games, and novelizations. As the *Star Wars* evolved its narrative coherence, these were acknowledged as canonical by the central authorial and licensing authority. This was part of the expanded universe, to be referenced in subsequent works and part of the core mythology documentation. This is not to say that all *Star Wars* authorized canon was ever definitive. Wookieepedia discusses many levels of canon, and the central authorial authority, from George Lucas to those responsible for licensing and approving, has always acknowledged that what is canonical outside of the core six movies is debatable.

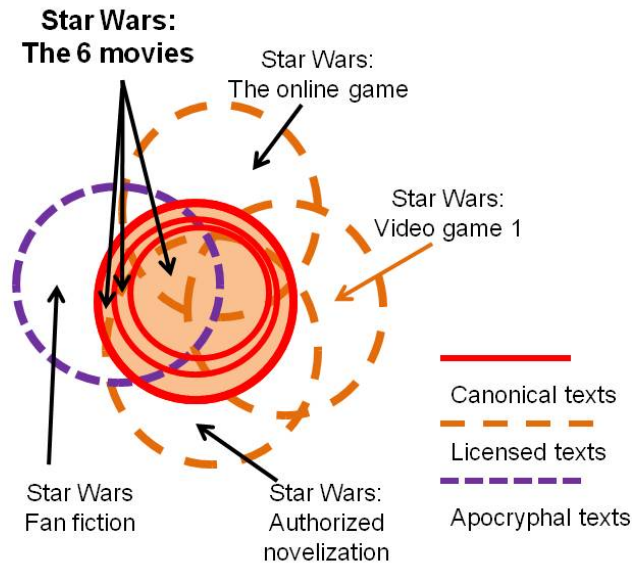

**Figure 14 Relations between storyworlds in the Star Wars system. Marie-Laure Ryan. Transmedial storytelling and transfictionality.**

In 2014, Disney purchased the *Star Wars* franchise from George Lucas and made a revolutionary change to the canon in an announcement to fans. The Expanded Universe, which as authorized and *Star Wars* reviewed material was considered canon, was now declared to be part of *Star Wars Legends*, a universe that had its own internal canonical rule set but was no longer to be considered canon for further works created with the *Star Wars* universe derived from the six movies, the *Star Wars* animated film, and the two *Star Wars* television series (*Clone Wars* and *Star Wars Rebels*). The brown dotted lines of Ryan’s diagram labeled licensed switched from canon to *Star Wars Legends*. In the diagram below (see Fig. 15) posted by the “Alliance to Restore Canon,” captured from a fan site, the two timelines show how much of the story has been lost. This reflects accurately the consequences of the canon alteration despite the use of fan charts. The

second set of charts reflects how those losses change the fans' understanding of Anakin's character and internal conflicts. His evolution was plotted out in stories in the expanded universe that are now considered irrelevant to the main universe. As Dena, Long, and Jenkins would have predicted, this has created consternation among fans, who remark in the small print, "6 years of canon thrown out the window. are you happy about this?"

### TIMELINE COMPOSITION

Old Timeline: 2002-2008

- Comics
- Video Games
- Novels
- Television

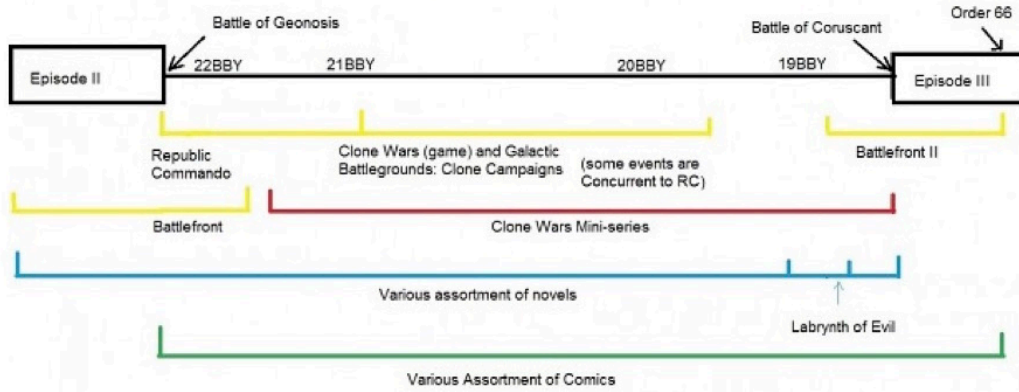

### TIMELINE COMPOSITION

New Timeline: 2008- Current

- Comics
- Video Games
- Novels
- Television

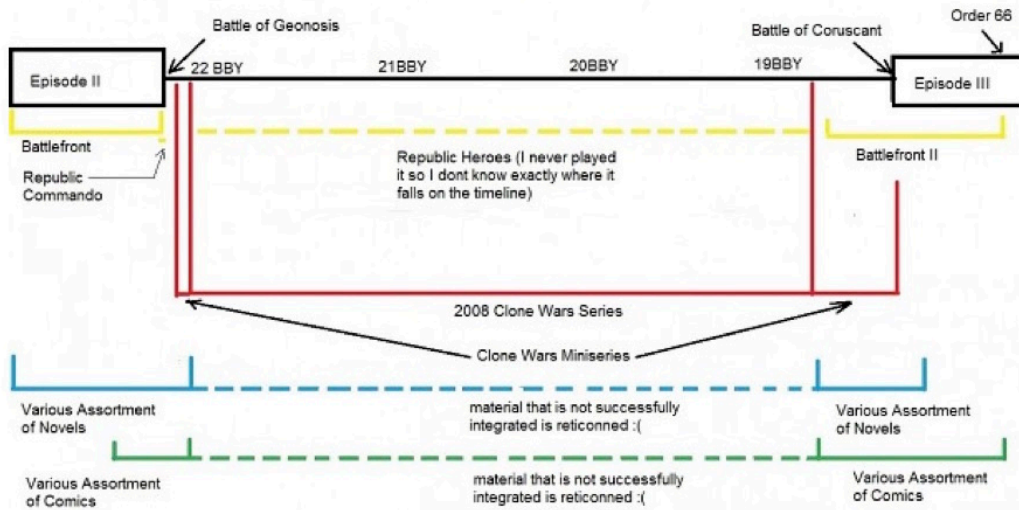

6 Years of canon thrown out the window. are you happy about this? post in the comments  
 NOTE: this graph does not contain any of the new clone wars comics and novels recently published

Figure 15 Timeline composition - Old and new timelines. Alliance to Restore Canon (ARC) [www.moddb.com/groups/alliance-to-restore-canon](http://www.moddb.com/groups/alliance-to-restore-canon). 2015.

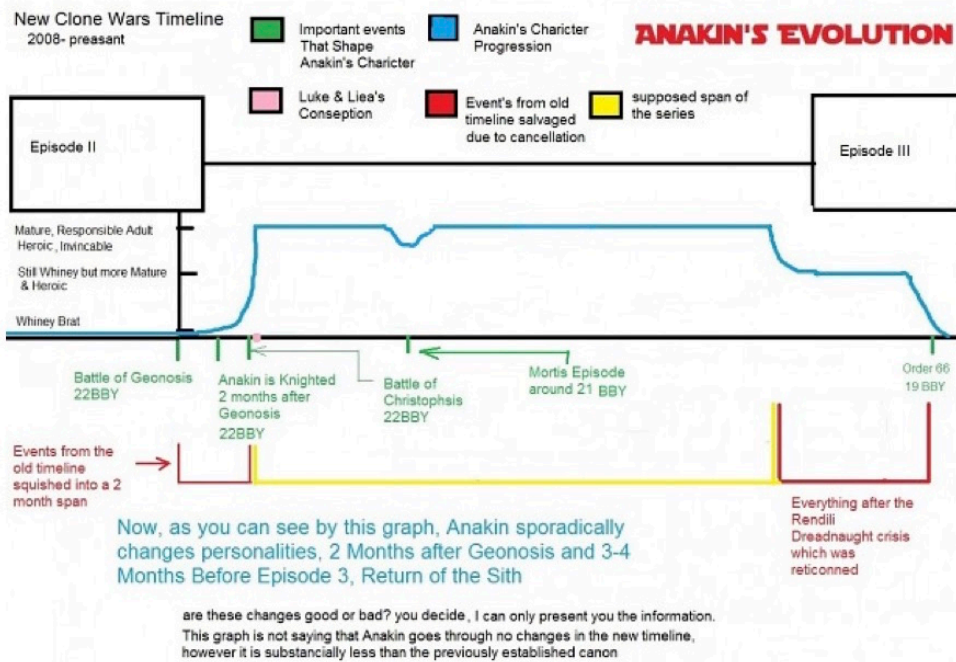
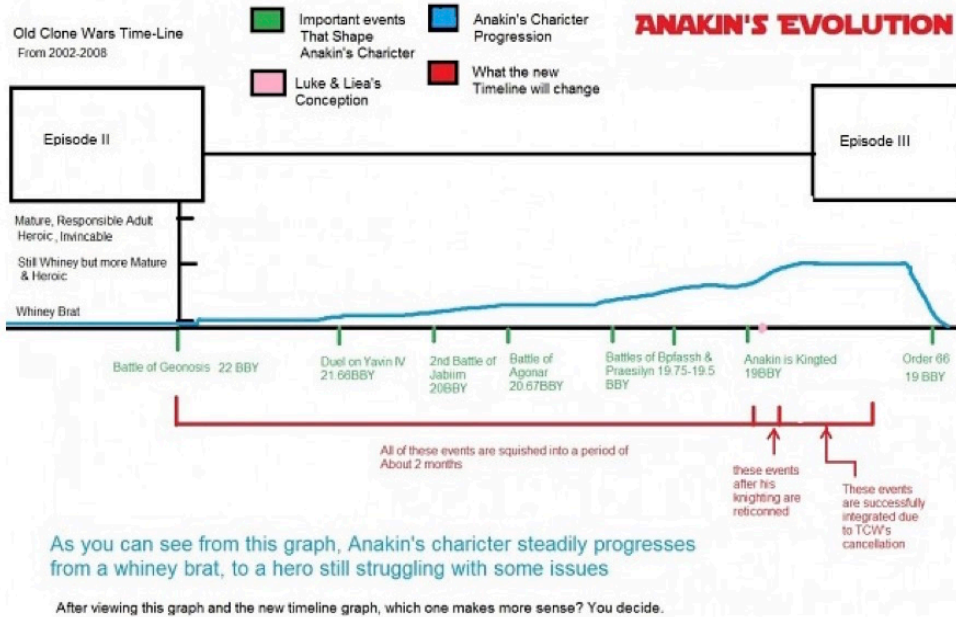

Figure 16 Anakin's character evolution and events- old and new. Alliance to Restore Canon (ARC) [www.moddb.com/groups/alliance-to-restore-canon](http://www.moddb.com/groups/alliance-to-restore-canon). 2015.

This is contrasted with two forms of continuity that feed a canon gestalt, one represented by a single unified canon, and two as a canonical multiplicity. Multiplicity is the multiple levels of canon that a storyscape may support. The Marvel Universe has worked to create a consistent and canonical universe, in its related movie franchises, while also trying to reconcile that with its comic book universe. Still, Marvel is left with multiple overlapping canonical stories that are inconsistent and contradictory. The comic book universe alone has seen many reboots and alternate timelines that have led to the term *multiverse*.

Continuity and multiplicity are instructive terms to contrast, but also define, the quality of canon as a parent category. Continuity can be defined as the consistency of canon whereas multiplicity can be measured by how well a storyscape holds together across a multiplicity of variations that look like a jazz improvisation on a theme. From a design approach, it boils down to how much you represent canon in each medium and how much consistency is required or can be explained away while still maintaining the gestalt of canon—a coherent storyscape despite contradictions. Continuity and multiplicity provide endpoints for a spectrum of choices about how the storyscape is read across media over time. In particular, these qualities are mostly thought about as the gestalt of the totality of the experiences related to a storyscape, or in these examples large-scale franchises, and how that affects the desirability and immersion of the experience for audiences engaged with other versions of media. Ignoring canon and a lack of continuity and fidelity to the values of a storyscape impacts fan approval and revenues.

Most examples of storyscapes that fit the canonical models outlined engage in a mixture of continuity and multiplicity over time because of commercial and creative pressures. The *Star Trek* storyscape exhibits both canonical consistency up to a point with regular departures to “what if” timelines and alternate universes. The *Star Trek* franchise was recently rebooted and reconceived as an alternate universe—one still connected canonically to the first through the totemic character of Mister Spock, who spans both universes. This also allows the authors to rebuild canon with variations. Most of the characters are the same in both universes, but their backstories and timelines are different. It also defines all the previous television shows (*Star Trek*, *STNG*, etc.) to a noncanonical position from the perspective of the new movie series. You can see effects of the branching on the previous *Star Trek* universe in the diagram below (Fig. 17).

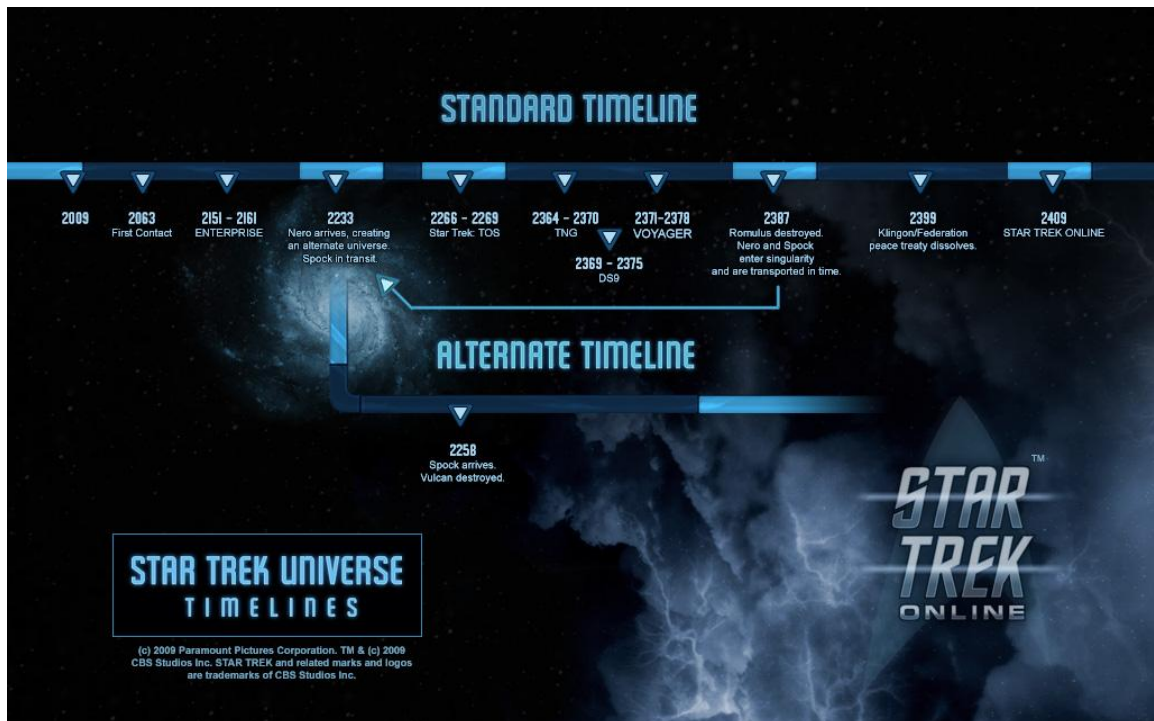

Figure 17 Star Trek Universe Timelines. 2009 Paramount Pictures.



Marvel, due to different licensing and revenue structures, has revised the universes of multiple character groups and emphasized certain multiverse constructions to support proprietary characters such as Thor and Iron Man. This is a storyscape model that already had multiple timelines and alternate universes to support creative expression. These are flavors in the gestalt of canon and still are determined by elements such as the characters and events that form the revised canon for the multiverse, usually altering only a subset of the canon. So in the *Star Trek* alternate universe of the reboot, clearly branched off canonically through a dimensional portal in the first movie, the universe has almost all the story mythology, including central organizing themes, characters, and conflicts. The expression is different, but the pattern is similar and recognizably part of the same story structure.

To summarize, canon as a gestalt allows the imagination of a coherent narrative, a whole. It also, practically, feeds into the mythology documentation, as part of the documentation and historical process for authoring storyscape. The advantages of canon are clear as a consistency that supports the appreciation of story and character through narrative cohesion, and logical consistency resulting from a comparison of different works of imaginary worlds in distinct media. Nonetheless, canon must be designed with the understanding that participants will engage canonical works that go beyond the authorized, from canonical changes of core texts decreed by intellectual property owners to noncanon such as paratexts and fan fiction.

#### **3.4.4 Genre**

Genre as a gestalt works to create a whole by setting a structure of expectations through aesthetics, archetypes, structural plot and scene similarities, and genre-specific

pleasures. A genre can be used to define the consistency of a narrative structure or aesthetics across works so as to increase comprehension through their comparison by inferring the implicit aspects of the genre. The genre works as a shorthand gestalt to reference elements not present in the storyscape or various artifacts. In discussing cyberworld design, Klastrup and Tosca (2004) note that, “A requirement for a genre to exist is that more than one single product shares the basic structure so as to be recognizable by audiences. Genres occur within one media, and often translate to other media (with different conventions according to the nature of each medium), for example there are science fiction books, films, and computer games.” This transmedial quality of genre becomes an essential gestalt in a storyscape because of its transmedia affordances. The genre gestalt becomes another unifying structure for a medium made of diverse media with overlapping conventions. The conventions of a genre, different across media, become a critical design gestalt for a storyscape in how the media products connect together and provide a referential ecology. For example, in the *Ghost Club* storyscape, the haunted house genre and the reality TV ghost-hunting show genre, as subsets of the horror genre, provide a gestalt scaffolding to form a whole work. The haunted house, its intrinsic expectations and historical narrative structure, works to connect the artifacts through its genre meaning structure. Transmedia stories, and the storyscape in particular, must leverage this gestalt as a conceptual model and as a function of each media’s unique narrative affordances. Klastrup and Tosca (2004, 1) highlighted the foundational nature by explaining, “The concept of transmedial worlds is very related to that of genre, as it has been described in literature and film theory. *Genre* is a descriptive and normative concept at the same time and depends on general recognition within an interpretive

community.” Observing the ecosystem of a storyscape, the participants and audience use genre to create narrative coherence within their community, and as a gestalt that outlines potentials and expectations of the story.

The genre theory referenced herein was developed in cinema studies to help define the rules and expectations of categories of movies (Kaminsky 1974). The film method is a refinement of literary and other genre approaches to define and categorize similar elements across stories. In our conception, exactly like film genre studies, these genres create a series of explicit expectations, conventions, and rules that can be merged with other genres or subverted but still exist as a skeleton of narrative and game expectation that enhance connectivity through consistency across media. As in film studies, genres will act as a container to define a construct of meaning within stories and describe what is legitimate. This definition of genre is the same as contemporary media theory’s. Examples include the study of science fiction in literature or the Western in film (French 1977) where genre rules set up expectation and structure and define bounds of believability.

The importance of genre is that it brings a pre-existing model of the world and expectations of what is allowed into contact with the mythology of the storyscape to create a more complete and, therefore, more connected and immersive world. The genre is the macro worldview that suffuses a storyscape and allows immersion to come from any part through meaningful context. Breaking the genre, like breaking the mythology, in different story/game elements undermines the connection and wholeness.

### 3.5 The Four Gestalts—Summary

These four gestalts—mythopoeia, character, canon, and genre—provide an infrastructure or skeleton to conceptualize and connect the different affordances provided by the stand-alone media products that are part of the storyscape. These connectors allow participants to project stories onto nonstory non-narrative media and embodied environments onto third-person media experiences. The effectiveness of these gestalts correlates with the perception of the work as a whole. This structural design approach works because the core meta-story, the storyscape, radiates out from these gestalts to the different media and their affordances.

This contrasts with other design approaches such as focusing on the production design of the storyworld or designing for negative narrative space. Geoffrey Long and others propose designing for negative story space by leaving story gaps to fill in and places that are unexplored in one work that can be explored in another. In the storyscape method, the negative space is a natural byproduct of the design process and not a primary design goal. A gestalt connects the dots, but also infers dots that may not exist and a field of negative capability—minor characters to explore, backstories, clues, and tangents—for what the gestalt model does not describe. Extending and elaborating a story by designing negative space to connect other media expressions is a peripheral connector whereas the storyscape approach focuses on the central myth-making engine of the connected story, the primary conflicts and elements that unite a story across media.

These gestalts, separately and together, form a whole that can be imagined by a participant or a community. From the specificity of the mythic conflicts,

through their expressions in character and through characters' actions, and resolving into a consistent imaginary world, as a subset of a genre that describes a cosmology and physics, these four gestalts—mythopoeia, character, canon, and genre—form a storyscape in each participant's mind, that also has the continuity and consistency, built within representational systems such as genre, to allow an audience to imagine the same storyscape and respond to a core story. The four come together and thread in and out of each other in a recursive mode, to ultimately express conflicts, characters, ideologies, and worldviews as a whole story. This whole story of the four gestalts is the medium of a storyscape, and its significance culturally and individually flows from the relevance of the meaning at the center of this story medium. The meaning-making potential is the myth-making story pattern, coupled with engaging characters, some coherence and fixed in a matrix of genre. The storyscapes of *Star Wars*, *Star Trek*, or *Lost* have the power of modern epics to confirm and reinvent meaning as narrative landmarks for the participants to employ, reenact, and imagine.

## CHAPTER 4

### LOST AS AN EXEMPLAR OF TRANSMEDIA STORYTELLING AND A STORYSCAPE

*Lost* constitutes a “storyscape” according to my definition, and the storyscape represents a new story form for artists and audiences. *Lost* is also an exemplar of transmedia storytelling—the storyscape spanned television, webisodes, wikis, games, puzzles, blogs, YouTube videos, and shipper forums. Transmedia producers such as Ivan Askwith (2007) and academics such as Janet Murray (2012) and Jason Mittell (2012) acknowledged that *Lost* had exploited the model of transmedia storytelling to market and extend its story. Furthermore, the emphasis on insider knowledge derived from the solving of clues in the show, and in other media, was a much-discussed pleasure of the show that was relevant to understanding the mechanics of this new form (I. Askwith et al. 2007). Canon, user participation, mythology, alternate reality games, and more media elements spread across every platform available surfaced the model of a storyscape for a vast television and media audience. Arguably the combination of digital affordances such as binge-watching and the second screens of computer information, embodied as laptops, helped codify a form of transmedia storytelling across media.

This chapter represents a research exploration in the mode of an academic fan who was part of the community as well as comparing it to the transmedia scholarship and publishing of the scholars’ notes above. This chapter is not written in the first person, but it could have been. My first-person experience was corroborated in the fan and scholarly community, so I am able to reference other parties for conclusions I shared. I reviewed

*Lostpedia*, the *Lost* wiki; tracked down videos on YouTube; visited blogs like *The Lost Notebook*; read articles; and had academic-fan discussions about the meaning of all this activity. I participated as a fan in this community as well as surveyed the academic literature about *Lost* and made an effort to participate in and consume the diverse media of this story. What follows are examples of how *Lost* maps to some of the theoretical and practical vocabulary discussed previously, how that compares to the previous analysis, and what can be derived from practice to be effected in the research project, *The Ghost Club* storyscape. This research was initiated first, applying the principles of transmedia storytelling in an academic/fan approach that was contemporary with its release. Thus what follows was used to elicit the four gestalts and the various affordances for design instead of an analysis using the design model of Chapters 2 and 3. This chapter indicates how a storyscape works from a participant's view and was used to derive the work in the previous chapters and the authoring of a storyscape in the following chapter.

#### **4.1 Comparison of *Lost* to Storyscape Concepts and Affordances**

*Lost* was a primetime TV show that was unique for having planned a finite storyline. Unlike the open-ended model of episodic television, it was envisioned to have a story arc that would reach a conclusion in the television medium. The alternative reality games and online videos added to the coordinated storyline, however *Lost* was economically a single channel and all of the transmedia storytelling aspects were viewed as marketing for the series. The alternate reality games were used to maintain interest between seasons, especially during a writers' strike that interrupted the narrative unfolding. Nonetheless, many media works were created by the authorial group and systematically distributed to provide a substantial amount of additional story content.

This fed a robust social media and fan engagement that was leveraged to achieve new transmedia story connections. *Lost* became a storyscape as it expanded its story across media and engaged in the principles and affordances of transmedia storytelling. It fulfills the definition of a storyscape and is an example of a storyscape where the myth-making, character, canon, and genre were significant concerns of the creators and participants.

First I want to touch upon some of the ways that *Lost* integrated the early and evolving concepts and affordances of transmedia storytelling. Topics including closure, subjective and different points of view, stand-alone content, collaborative authorship, and encyclopedic are noted. They show the breadth of transmedia production and consumption and relate to theoretical and evolving practice methods of a storyscape.

While *Lost* was conceived of as a complete television story, as a transmedia expression it lacked narrative closure. The various story extensions in different media and story forms pushed the story beyond any boundaries. Characters and storylines in *Lost* were fleshed out in the other media mentioned previously and subsequently. These helped clarify intentions by adding different characters' points of view and backstory. Characters were given more complex reasons for their actions. In the *Lost* webisodes, viewers find out that Sun, a Korean castaway who figures prominently with her husband Jin, almost kisses Michael, another castaway. This adds emotional complexity to all the involved relationships. It is additive because the audience knows she had another previous affair told in a broadcast episode told in flashbacks. Extensions allowed the *Lost* creators to explore the backstory of the Dharma Initiative and the Hanso Corporation through the *Lost Experience* and other ARGs that provided clues and information spread across the web and social media.



*Lost* had some typical entry points, such as a video game *Lost Via Domus* and *Lost* puzzles but other entry points in *Lost* were less accessible and failed to meet one of the earlier discussed properties of transmedia—the ability to stand-alone as content. The *Lost Experience* reality game was specifically for knowledgeable users. Since *Lost* was a very complex long arc television show, it required people to know the sequence of events to follow the story. Thus *Lost* gives amplified meaning to forums and information online to fill the gap of narrative comprehension and provide new entry points for the show. In the case of *Lost*, these transmedia entryways do not have a low threshold but rather help the casual user hurdle the complexities of the show. The networks also created new enhanced episodes and clip shows to encourage these entry points. Enhanced shows featured “pop up” commentary and sometimes pictures while other information also ran along the screen so that viewers could pick up or remember what had happened in the past (and future). In this case, *Lost* was successful in creating and maintaining entry points but wasn’t able to create new stand-alone (games, movies) media platforms that could bring in an entirely unique audience.

Nonetheless, the variety of media related to *Lost* was stand-alone, fulfilling the storyscape model and Jenkins’s West Coast transmedia model. In *Lost*, there was an earnest attempt to use multiple forms of media, consumable individually, to collectively focus the story experience while also existing as a self-contained experience. The *Lost Experience* was a stand-alone experience exploring a relevant but tangential aspect of the narrative system. So were the game and puzzle in providing clues but both existing entirely within their own story paradigm. The level of unique contribution by each form is debatable, but there was intent to create narrative experiences that are in their story

silos while also adding collateral understanding. The vast amount of extras on each season's DVD release is a testament to the desire for collateral content that entertains on its own terms as drama or backstory.

The lack of closure and use of authorized extension emphasized co-creation and authorial control. In the case of *Lost*, there was strong authorial control in the form of a group of writers or showrunners, the writers/producers who supervise a stable of writers. They exercised a powerful measure of editorial control over the multiple alternative reality games and additional content. Additional content existed as webisodes, DVD extras, and even a short extra final episode that occurs after the show ended. These story extensions were defined as within "canon," the authorized story, and often written and directed by the same people as worked on the television show. Because of the complex explanations in *Lost*, evoked in mythology documentation and myth-making, there was an extraordinary coordination required to extend the vectors of *Lost*'s story to other media and into the "real" world. The *Lost* myth-making and mythology exhibited the storyscape quality of being highly coordinated. An invested audience comparing all media sources and debating the legitimacy of canon and how the story worked together as a puzzle to be solved examined consistency and coherence.

In an interview with buddy.tv, Damon Lindelof and Carlton Cuse (2007), the showrunners, explain the relationship between *Lost* and the *Lost Experience* and the supervision between what is in canon and what is tangential:

Carlton Cuse: I think that for us, yeah, I mean, all of and his relationship with funding the is part of the mythology. The details of the demise . . . it's tangential to the show but it's not unrelated to the show. We sort of felt like the Internet

Experience was a way for us to get out mythologies that we would never get to in the show. I mean, because this is mythology that doesn't have an effect on the character's lives or existence on the island. We created it for purposes of understanding the world of the show but it was something that was always going to be sort of below the water, sort of the iceberg metaphor, and the Internet Experience sort of gave us a chance to reveal it.

Damon Lindelof: I would say in terms of all the . . . background that we did, in terms of the Valenzetti equation and explaining the formation of the Hanso Foundation and doing the other films . . . we'd consider that stuff cannon to the show. Where there'd have to be wiggle room is the Rachel Blake story where she's in the real world, in the outside world as we define it . . . we can say that all the factoids that she was uncovering were vetted, in fact many of them were written by us personally so they are cannon [sic].

It is important to note that the canon they are defining is how to depict the mythology documentation and myth-making backstories that connect the various works into a whole as they delegate the creation to other media creators.

Collective intelligence is often the means used by the authors in the ARGs and the audience to explore the extensions. *Lost* is a good example of new forms and models of digital communication and collaboration in a storyscape. *Lost* brought to the forefront the cultural decoding of story elements through digital media.

Of Janet Murray's four qualities of digital environments, which are foundational to the storyscape, the participatory quality is the most applicable to the use of collective intelligence in *Lost*, but the interrelationship of these qualities is what provides a

foundation for crowdsourcing answers or plot through an audience's collective intelligence. In crowdsourcing, or collaborative problem solving, the use of encyclopedic sites such as Wikipedia to share and disperse information became essential to unravel the transmedia elements and for some, necessary to have a reasonable comprehension of the story. *Lost* was a story that deliberately obscured causality and also encouraged alternate explanations, so the online application of narrative resources was a perfect counterpoint. Viewers in confusion looked to fan forums, *Lostpedia*, and blogs for answers to move their understanding forward.

In the case of *Lost*, the story was so dense and complex, involving so many characters and narrative arcs that there were naturally many gaps to explore. This applies to less complex stories where the limited time of exposition often leaves backstory and side stories as untold. The distinction here, and specifically as it applies to *Lost*, is that the development of stubs of ideas, mysteries, or mythological aspects are deliberately planted in one text with the expectation of their development in other mediums. *Lost* was such a profusion of these stubs that it provided easy material for exploration in the other media. This also encouraged an encyclopedic impulse for fans to document and explore the tiniest details in search of clues or pieces to the answer the questions posed by the plot or mythology that was being revealed. The illustration (Fig. 18) below shows the various platforms that comprised the *Lost* storyscape.

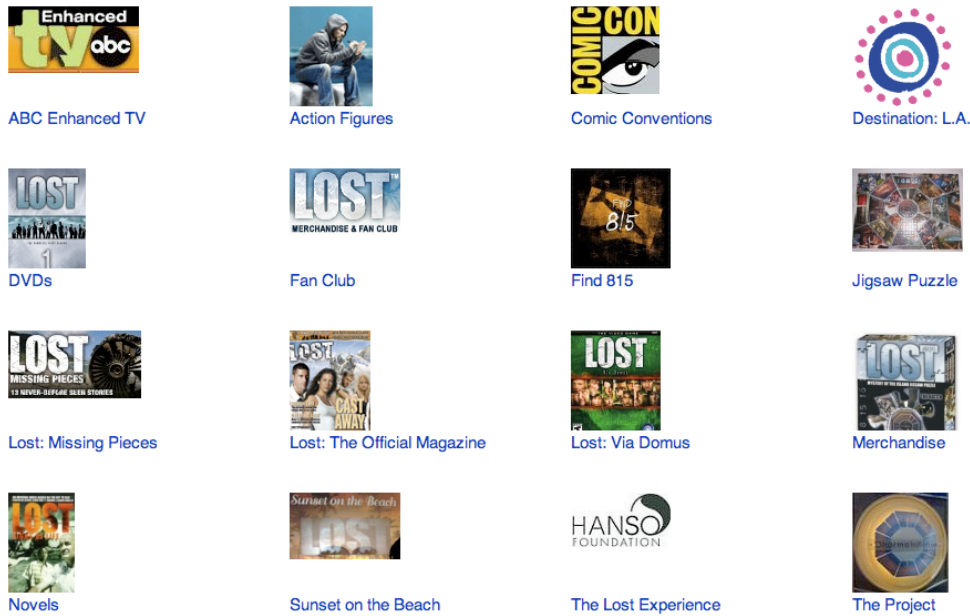

Figure 18 Some of the Elements of the *Lost* storyscape

## 4.2 Analysis of the *Lost* Storyscape

In order to analyze *Lost* as an exemplar of transmedia storytelling and a storyscape, it is well to return to Henry Jenkins (2006a, 95) definition from *Convergence Culture*: “A transmedia story unfolds across multiple media platforms, with each text making a distinctive and valuable contribution to the whole. In the ideal form of transmedia storytelling, each medium does what it does best—so that the story might be introduced in a film, expanded through television, novels, and comic; its world might be explored through gameplay or experienced as an amusement park attraction.” In the case of *Lost*, Jenkins’s definition preceded the significant contributions of *Lostpedia*. Other significant aspects included *The Lost Experience* and other alternative reality games sponsored by the show (I. Askwith et al. 2007). Clues, hints, and videos have also been posted to fictional websites, presented as DVD extras, and in other ways distributed to the *Lost* community.

*Lost* meets Jenkins's definition of transmedia storytelling and also exemplifies a strong authorial intentionality by the writers and creators. *Lost* is one of the few works that has emerged as an example of intentional storytelling across media—the relevant difference is that examples such as the *Lost* and the *Matrix* franchises were designed as a storyscape instead of the ramshackle development of the *Star Trek* and *Star Wars* franchises where new media has been grafted on. Recent years have shown Disney's transmedia savvy at planning an integrated platform and the emergence of the *Star Wars Universe* with a timeline for a new set of canonical transmedia works.

*Lost*'s storyscape of alternative reality games, wikis, webisodes, and video games added new vectors for accessing a story. By examining these interrelationships and story additions, a user unlocks the meaning of the conclusion of the show as well as the way that transmedia storytelling worked. By consuming the whole storyscape, a participant would be in a better position to understand the stakes or explanations than if they only experienced one facet. This highlights one of the contentious issues in transmedia storytelling—the plot and its relationship to the stand-alone elements. In an apparent contradiction Jenkins, and other transmedia experts such as Jeff Gomez, assert that each experience—movie, show, game, or ride—should be stand-alone. If taken to its logical application, that would indicate despite the interlacing of stories and narrative puzzles across media that participants would not find any further significant understanding than derived from any individual element. So, regardless of the weaving of *Lost* across media (and with some of the locus of stories within the fan base and the community and thus partly outside any authorial media control), Jenkins (2006a, 96) notes, “each franchise needs to be self-contained, so you don't need to have seen the film to enjoy the game, and

vice versa.” This is a laudable goal and makes narrative and financial sense that each part would provide a complete and satisfying story, game, or other experience that is pleasurable in its own affordances. Nonetheless, a participant must wrestle with a definition of transmedia storytelling that can encompass the contradiction between the stand-alone story that many participants found incomplete and the exposition of narrative information across media. To clarify, this conflict focuses on one of the key considerations of transmedia storytelling—how you disperse a plot across media and create a whole story. It also highlights the research project, which disperses plot elements across media but uses the four gestalts to create a narrative unity instead of an unfolding diachronic narrative.

What fosters a circle of viewers who are in the know, and by that I mean understand the breadth of story not contained in a single medium? Two transmedia storytelling concepts Jenkins (2006a) calls synergistic storytelling and additive comprehension help frame this understanding. Synergistic storytelling, a term coined by Ivan Askwith (2003), is the placement of relevant information in other texts and media so that the story requires that knowledge for complete understanding. The *Lost Experience*, an alternative reality game designed by the writers and producers of *Lost* to continue the narrative between Seasons 2 and 3, was a parallel story told through websites, clues to unravel offline, videos that are uncovered, and real-world interactions such as the publishing of a book that appears on the beach of the island. Examples of *Lost* revelations include the meaning of Dharma—the group that sets up the research stations on the island that the castaways discover and are a far-reaching element of the *Lost* “mythology” backstory and central conflict story arc—which is revealed to be an acronym for

*Department of Heuristics and Research on Material Applications*. Furthermore, those who locate and decode the clues on the websites and in the videos (additional Dharma orientation films and video blog postings by an investigator) discover it was set up by *Alvar Hanso* to investigate the Valenzetti equation, a research project suppressed by the United Nation in the 1960s that predicted the end of the human race. These clues help the viewers understand the mythology of the island, its puzzles, and its purpose, as the show reveals its myth-making core and character conflicts. Some of the unfolding information satisfies genre expectations, science fiction in this case, such as plausible scientific explanations of supernatural events. Others surface a hidden canon that fleshes out the whole storyscape gestalt more thoroughly.

Further, significant plot information revealed is that according to the Hanso Foundation, Valenzetti's equation is based on a set of core numbers—4 8 15 16 23 42. These numbers are central to the story and mythology of *Lost*. Hugo, one of the main characters in *Lost*, has a character arc defined by winning a massive lottery using those numbers—many Hugo flashbacks revolve around the meaning and power of these numbers. In the final season, these numbers reveal their alignment to the “candidates” to fill Jacob's caretaker role on the island. (Jacob is one of the two persons endowed with supernatural powers who compete for dominance of the island.) In this instance, seemingly crucial information for understanding both the plot and motivation was located outside the principal medium. Thus, we can infer that the locus of the narrative experience is partly outside of the TV series or main text when looking at comprehension in transmedia storytelling. A satisfying experience can be obtained in each medium, but nuances and added story, or character dimension may be lost.



A second form that requires multiple media sources is additive comprehension. Additive comprehension is when stories in other media provide a new point of view that gives deeper, greater, or new understanding. In dynamic examples, it can cause you to reorder that information into a new meaning of the central text that may change your decipherment completely. If you rewatch the cardinal text, it may be altered with this additional story information. A clear illustration of how additive comprehension can work is *The Plan*, a TV movie released after the recent (second) version of the TV series *Battlestar Galactica* (BSG). *The Plan* existed within the storyworld of BSG but changed the comprehension of the story by adding deeper but consistent information to characters in the world. *The Plan* shows how a new vector or point of view can change or enhance a grouping of stories that exist within a transmedia storyworld and, in this case, change the entire previous series.

In BSG, the core plot revolves around the survival of a few remaining tribes of high technology humans who are fleeing Cylons, a robot life form in the shape of humans and robots. In *The Plan*, the story is told from the point of view of the human-like Cylons. In this story, we see that Cylons were not monolithically evil and single-minded in devotion to the genocide of the human race. They had multiple points of view, mistakes, disagreements, and good intentions. Scenes that presented one interpretation in the TV show were upended in *The Plan*. Once viewers understood that the “bad guy” that was the Cylons was neither monolithic nor evil, then viewers’ understanding of the six seasons shuffled and changed like a railroad departure board.

Additive information doesn’t have to be transformational as in *The Plan*. Additive comprehension in *Lost* works by layering in more informational depth and perspective

through subplots and the partial resolution of mysteries and is the most relevant to the transmedia experience of it. The motivations of the Hanso Corporation, the sponsor of the Dharma initiative and a key entity in fictional websites, are exposed through the protagonist of the *Lost Experience*—Rachel Blake. She is the daughter of Alvar Hanso, the founder of the company named after him, and is able to expose the goals and failures of the Hanso Corporation parent of the Dharma initiative. Since the explication of the Dharma initiative—the people who built the mysterious hatches and created the orientation or training films that provide background on the island, its history, and buildings—is of interest to both puzzle solvers and story meaning. Additive comprehension in this context creates a hypertext-like story structure that surrounds the main TV series that ideally adds to the pleasure of understanding through a more complete comprehension. Appropriately, this hypertext structure of linked stories across media is both representative of the deliberate nonlinear story structure designed by the creators of *Lost* and the possibilities afforded by digital media to add new facets to causality and comprehension.

Causality and comprehension are lost in *Lost*, as the exposition of multiple texts depicting multiple alternate realities begins to emerge in the television series. *Lost* explores time travel and multiple universes threading scientific plausibility into the narrative. *Lost* encourages these conceptual gaps with flashbacks, flash-forwards, and flash-sideways (a term coined to define the “sideways” world in *Lost* where the characters have an alternate timeline where they are not stranded on the island), discussed more thoroughly in the subsequent paragraph. With the additional media instantiations and participatory nonauthorial contributions including fan sites and theories, this created

a multiplicity of causality and plot explications. However, the authors were careful in this blizzard of possibilities to hold tightly to the core myths they evolved and the mythological documentation as canon that had emerged. Since the plot became a confusion of potential what ifs and alternative universes the authors hew closely to the original through line of important characters to create an organizing principle to our conception of the storyscape. Each episode focused on a single character, often including and contrasting events across time. This allowed character to also act as gestalt to conceive the series as a whole while the plot and causality splintered, only held together by core myth-making that united the storyscape.

Returning to the conclusion of *Lost* and Jack's closing eyes, the language of motion pictures conveyed one meaning but the nature of the transmedia storytelling experience, and the story, implied other possibilities. However *Lost*, the TV series, also had stand-alone narrative qualities that offered multiple interpretations and points of view. Confusingly, the narrative structure of *Lost* contained time travel, flash-forwards, flashbacks, flash-sideways. Nevertheless, the sideways story is causally (if casually) linked to the main timeline, and alternative universe explanations are implicated (and abound on fan sites). The audience is encouraged to see the sideways world of *Lost* as a parallel universe because it had the same characters of *Lost*, but a subtly different history of events—a history where the plane never crashed or time was changed in the past creating an alternate timeline.

In *Lost*, a parallel timeline was incorporated where the jet that crashed, Oceanic 815, lands safely, and we see a version of events that play out very differently than what happened on the island in the past and future. Thus, a multiplicity of framings was

created so the audience could find a broader gestalt of the story across media. In this case, canon was incoherent encouraging the participants to create their interpretations. The sideways world is an example of how *Lost* can mystify in one medium and explicate in another. Sideways designates that it is neither flash-forward nor flashback, but rather sideways in time. The sideways world, so named by the fans of the series who were trying, and failing, to place these scenes in temporal and causal order—past, present, or future. Since the history of the scenes, the causality of the events was contradictory then fans denoted this subworld, or alternate reality, as the sideways world to create a coherent model of the disparate and contradictory elements.

In trying to make sense of this world, fans quickly leaped to the idea of a parallel universe as explained by quantum theory. This idea was encouraged by *Lost*'s science fiction genre and scientific themes. The mysterious effects of quantum physics seemed a perfect foil for the science vs. faith debate that raged in *Lost*. Further strengthening this linkage was the narrative placement of the sideways world stories. Juliet, the doctor who falls in love with Sawyer (the anti-hero, ex-con man), detonates a hydrogen bomb in the year 1977 where some survivors have become trapped in time (the heyday of the Dharma Initiative). This detonation is in an attempt by a group of the time traveling castaways to change the future and prevent the plane from ever hitting the turbulence caused by the Island's electromagnetic field. This is the end of Season 5.

Season 6 begins with everyone once again on Flight 815 when it hits turbulence—but doesn't crash. The implication is that they are successful at changing the timeline as we begin to follow this alternate path. However, we are soon given another path to follow—we pick up the story again in 1977—where there is no effect at all.

Again the conventions of motion pictures indicate an outcome that is not true. While the authors of *Lost* clearly mislead the audience into believing one thing—that the castaways have entered an alternate universe where there was no plane crash—at the end of the season, we discover conclusively that the sideways world is some purgatory or heaven (as defined by the fans in online forums). The sideways world turned out to be a place where all the characters lived waiting for each to die in turn and eventually be reunited in a church before an undefined “moving on.” *Lost* as an exemplar underlines the inadequacy of a transmedia scholarship aimed solely at the logical, causal, or plot-based connections between stories. The storyscape creates its larger meaning between the conception of the whole imagined by the multiple authors and negotiated with the participants.

Causality was abandoned despite this being a show about the rigid causality of solving such complex detective puzzles, often requiring the new affordance of collective intelligence to unlock. Normally an audience would call foul at this point (and the *Lost* community was very vocal) but the fans of *Lost* consumed these multiple viewpoints and contradictory concepts with a relish that would confound Aristotle or Bordwell. There are other satisfactions that are stroked in *Lost* the TV series and across media. I will return to these other pleasures, but my concern is with trying to understand the barriers or tools that transmedia storytelling provides in helping an audience understand the closure or lack from the ending of *Lost*.

This multiplicity of narrative forms has two main implications for understanding the viewers’ experience of the ending of *Lost*. First it situates *Lost* squarely within the genre of science fiction, and also in other subgenres like the “Time Loop.” In the Time

Loop genre, characters are transported to the past and then travel forward into the future creating a loop—usually with the intention of changing history and the outcome. The use of the Time Loop conventions made possible a great number of explanations within the conventions of that genre: Jack’s eyes could be closing in the past, the future, or a dream. Indeed, already established complex plot devices such as the sideways world, which can be interpreted as another dimension (another universe that shares some but not all of our causality) already make it difficult to discern where we are in the story. If you have multiple dimensions present with your story that constitutes another “supernatural” device where anything is possible, and this is a direct threat to causality and my comprehension.

The second implication is that the “narrative space” where Jack closes his eyes could be either a flashback, flash-forward, or flash-sideways. Research into fan reactions to the ending—posted as multimedia essays on YouTube, hotly debated in forums on *Lostpedia* (“Lostpedia” 2013), and heavily documented on a host of *Lost* blogs and websites like *The Lost Notebook* (Hanttula 2012)—indicated there were many confused explanations and the intense puzzlement of millions of fans. It is apparent that Bordwell and Thompson’s (2010) analysis is at least partly true as it applies to *Lost*. Not everyone received all the same story information, and there were many different conclusions about the ending. The emphasis was on the “multiple” readings of the work and not as much on the “shared” experience Bordwell and Thompson call attention to—ironically creating a drive to “share” the experience across fan sites and blogs, and around water coolers at the office. And yet ironically this additional information, shared experiences, and collaborative problem solving had not resolved into an agreed explanation.

### 4.3 Character as Focus for the Participants

Viewers' experiences of the last episode of *Lost* ("The End") expressed it to be one of the most emotionally potent television conclusion episodes, and this was confirmed by the mythology-confused fan base (heroine\_tv 2010). The closure of multiple character storylines such as those realized in the sideways world and Jacob's decision of who he would choose as the replacement caretaker for the protection of the island and its powers and mysteries satisfied many character arcs and relationships. The many characters' resolutions on a personal level resonated so powerfully with many participants that this understanding and closure competed with the apparent lack of resolution of the mysteries of the island (Baker1000 2015). The complexity of the *Lost* character ecosystem was graphed by *Wired Magazine* in the picture below as the show drew to a conclusion (see Fig. 19). In a blog post on *Lostpedia* page titled "5 Years After LOST—Why It's Wrong To Judge the Show on The End," Baker1000 (2015) declares: "*Lost* was always a character story, the mysteries were always supposed to play second fiddle."

Many participants achieved a substantial sense of understanding and resolution despite a lack of comprehension of how the conclusion resolved the mysteries in a

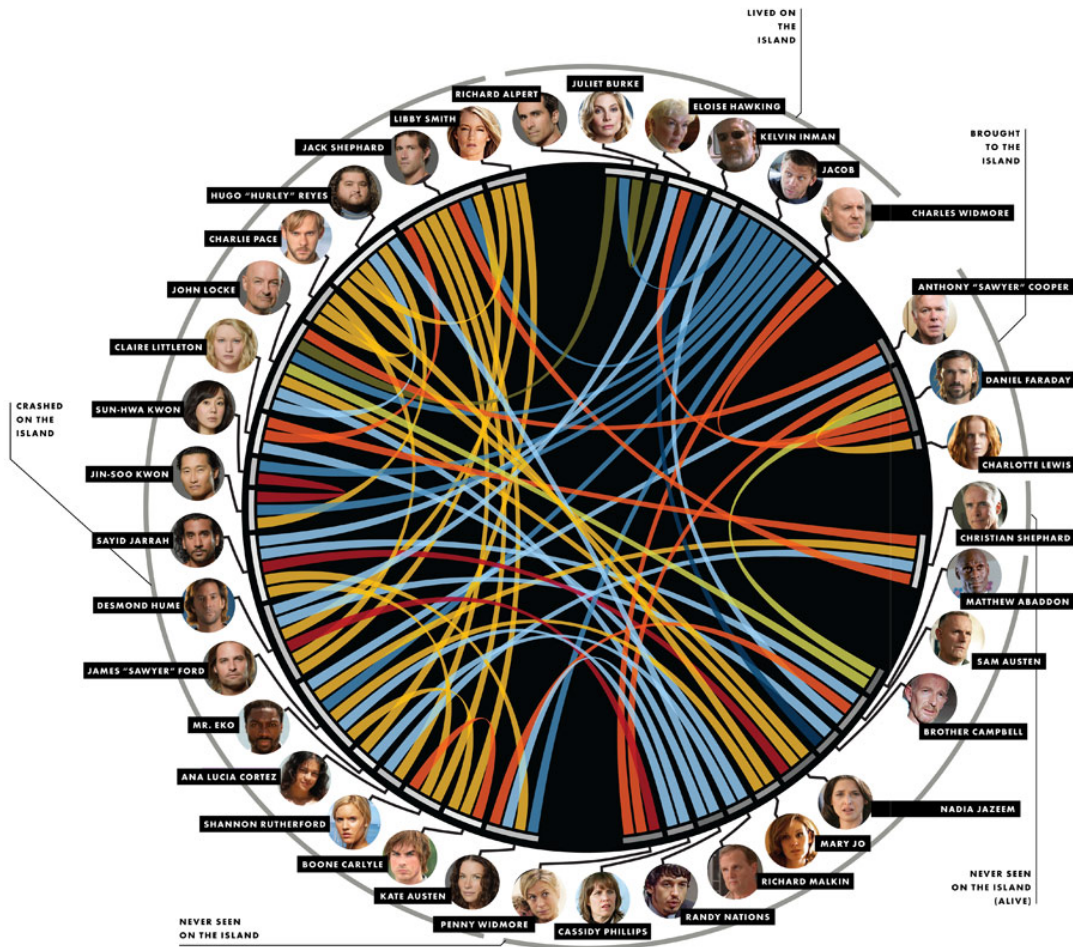

Figure 19 *Lost*: The complete character web. Wired Magazine.

logical, or science fiction genre, mode of plausible explanation. For the producers and creators, this was a satisfying experience to bring an audience to—a powerful emotional catharsis. So Bordwell and Thomson (2010) were wrong; some aspects of story were working despite appearing to be broken by the inconsistent experiences of the viewers. The additional points of view and forms of immersion felt by exploring the games, blogs, webisodes, and other content—even rewatching the final episode “The End”—created a sum greater than the whole of its parts—a powerful story ecology, or storyscape, that continued beyond the end of the show.



Why is the ending so emotionally satisfying even though it is confusing as a story or plot? This is because there is more going on in a storyscape than any one narrative path that can be analyzed. The different pleasures and emotional aspects those stories support across diverse media platforms represent many different entry points to stories as well as potential multiple perspectives on a story. Viewers who self-identified as shippers expected and desired Jack and Kate to get together, so their satisfaction was often enhanced or depressed by the ebb and flow of that relationship. Shippers find satisfaction in seeing Jack together with Kate in the sideways world and also in the flash-forwards of the time they spent together after they left the island (though these are not always happy or together)—this allows a participant to fulfill their narrative romantic desires expressed through characters. When Kate hooked up with Sawyer, the anti-hero of the show, then one meaningful aspect of the show was minimized for participants “shipping” for Jack. Others expressed pleasure when Sawyer took up with Juliet (see Fig. 20 below, copied from a shipper forum).



Figure 20 *Lost*: Juliet and Sawyer connect in the past. <http://www.heroinetv.com/2010/06/16/lost-yeah-its-really-the-end-part-ii/>

The definition of a shipper below comes from the *Lost*-Forum.com rules, a fan forum to discuss the *Lost* television show and topics related to it

**Ship:** n. a romantic relationship between two characters.

**Shipper:** n. someone who promotes a romantic relationship between two characters.

Shipping is a powerful narrative impulse that is addressed not only by shipper communities online but writers of the show because they are also sensitive to the interactive concerns of the *Lost* community expressed in blogs and forum discussions.

In profound and emotional ways, the conclusion of the show rested on the ability of the writer/producers to bring to a satisfying resolution the interpersonal relationships of the characters—in particular, their romantic relationships, which are not traditional for science fiction. Character is central to a transmedia drama as it was historically, but more

protagonists and antagonists were supported. Some resolutions are only about the pleasure of seeing the character move on; others are about couples reunited or finding closure, and most powerfully, the feeling of making peace and the justification of the character's life and efforts. Juliet reunites with Sawyer despite her death in a previous episode, and the authors spend much of the last episode resolving our feelings about Kate's twisted multiple relationships with Jack on the island, once they escape, and in the sideways world. As unsatisfied as many viewers were with the plot's resolution, the emotional logic of the characters' relationships tied up snugly. For a shipper watching Jack and Kate kiss in the last episode and say "I love you" was the ultimate closure. There is no definitive answer whether this viewer catharsis was enhanced by the forum speculation or creative short stories read and written online—however involvement often translates into immersion and emotional resonance.

#### **4.4 Pleasures of the Medium: A Medium of Media, *Lost* as a Storyscape**

The multiple pleasures that interweave modalities like games, stories, and romantic models—or the design principles that translate into myth-making, engaging with characters, the pleasures of the genre, and a consistent canon—are well suited to the interplay of stories and games across media that is a storyscape. Transmedia storytelling adds a focus on different modes of experience such as shipper forums, working path story-games, and additive comprehension. If these structures are reviewed in context, then the overlap creates a narrative ecology of a storyscape. Jenkins (2010a, 943) expounds:

A transmedia story represents the integration of entertainment experiences across a range of different media platforms. A story like *Heroes* or *Lost* might spread

from television to comics, the web, computer or alternate reality games, toys, and other commodities, and so forth, picking up new consumers as it goes and allowing the most dedicated fans to drill deeper. The fans, in turn, may translate their interests in the franchise into concordances and Wikipedia entries, fan fiction, videos, fan films, cosplay, game mods, and a range of other participatory practices that further extend the story world in new directions. Both the commercial and grassroots expansion of narrative universes contribute to a new mode of storytelling, one which is based on an encyclopedic expanse of information which gets put together differently by each individual consumer as well as processed collectively by social networks and online knowledge communities.

Jenkins is addressing the myriad ways to access parts of a storyscape as well as the way that a transmedia story can exist in a cloud of media and communities. While some participants project romantic relationships on the characters in the television show others may have obsessed with clues and collaborative problem solving. Puzzle solvers find interest in the puzzles, games, and crowdsourcing exercises buried in the *Lost* storyscape as a form of detective work. This detective work is a new pleasure in a story form that was not previously afforded.

A storyscape allows the creators to tease apart the various narrative experiences, whether spectacle, fear, puzzle solving, or romance, into their spheres where they can excel but still access the central story, myths, and emotions. The creators of *Lost* also allowed those experiences to be knitted together into a potentially more powerful whole as different media experiences become cumulative. The social networks and digital media

distribution create easy access to the portion of the story that lives outside the work. These gestalts allow participants to live *Lost* as a meaning-making experience at the water cooler, online, in games, and then combine those social and story lines into a powerful emotional catharsis at the point of a single instance of storytelling. Many viewers failed to unravel the confusion they experienced at the ending but an equal number expressed an emotional closure to the relationships between characters and also in their relationships to the characters. The picture below (Fig. 21) was posted on a *Lost* blog with the caption, “*For my shipper friends. Enjoy!*” and seeing this kiss between Jack and Kate in the final episode—signifying a coming together and, in some odd way, a promise of being together forever—was perhaps all the explanation needed.

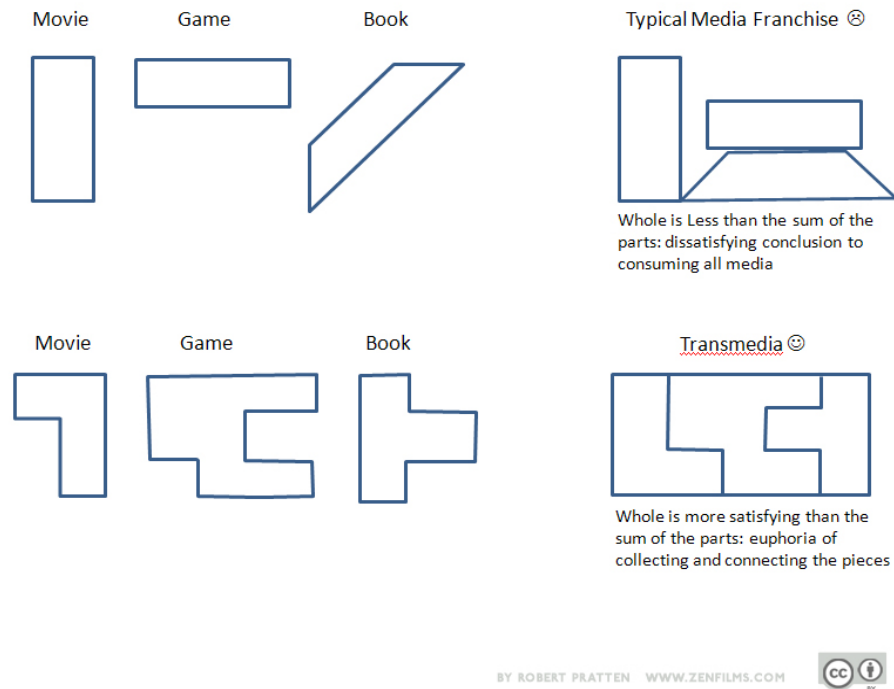

**Figure 21 Jack and Kate formed the core shipper relationship that was complicated by Sawyer and explored in the "sideways" world. <http://www.heroinetv.com/2010/06/16/lost-yeah-its-really-the-end-part-ii/>**

Transmedia storytelling and storyscapes are a fluid form that is still developing. Jeff Gomez says, “Transmedia isn’t about porting the same content across multiple media, but doing so in such a way that each platform contributes a new and unique aspect

to the story” (New Media Age 2010). This method applies to the analysis of *Lost* because diverse experiences and vectors on the series were created to take advantage of the unique affordances of each medium and digital media in general. Podcasts, webisodes, and alternate reality games leveraged the new digital technologies, exemplified by Murray’s four essential qualities. This provides unique terrain to explore that was adjacent to the central story but resulted in whole new works. These vectors of transmedia storytelling occur at angles to the main storylines. “Some people think of transmedia storytelling as a giant jigsaw, where the pieces exist on different platforms,” says Simon Meek, producer at Tern TV, which produced transmedia-style project *The Beauty of Maps*. “As the user consumes these isolated chunks, they combine to create a bigger story” (New Media Age 2010).

In the diagram below (see Fig. 22), Robert Pratten, the founder of the transmedia storytelling tool *Conducttr*, shows graphically the way transmedia storytelling was conceived as fitting its parts together in the form of a puzzle to fashion interlocking links that border and support each other. The diagram is oversimplified in that it doesn’t clarify important points about plot, what is in a medium, and what story crosses media. The inadequacy of this diagram and the way it displays relationships across media is a pointer to the need for the four gestalts as a unifying conceptual and design model. The gestalts are more powerful than this interlocking pattern and reference core myth and character not noted below.



**Figure 22 Robert Pratten indicates the way various media interlock in transmedia storytelling in an overly simplistic version of transmedia storytelling. The point is the diagram doesn't explain transmedia storytelling. [www.zenfilms.com](http://www.zenfilms.com).**

The exploration of the myths and characters provides new vectors of stories. In the case of *Lost*, it can function explicitly as a puzzle with each media providing clues and creating a larger narrative whole. The clues present in solving the literal *Lost* puzzles, physical real-world cut cardboard puzzles, answer narrative questions. The puzzles featured a black light paint, revealing with a black light the maps of all the island's installation such as the bunker called the Swan station. It was very similar to the blast door map revealed in a flash in Season 2. These puzzle maps were more complete, and the clarity was superior. The puzzles also included clues to an Ottendorf cipher (a book cipher to encourage participants to access the text) that explained the cryptic codes revealed in the black light on the puzzles. That cipher uses a text, in this case, *The Turn*

of the Screw—a novel that is seen in the Swan station—to code words and clues. For people who were interested in this vector of the story, it allowed a visceral and intellectual pleasure in maximizing comprehension and pinning down meaning while solving puzzles. Below is an example of the completed map from the puzzles (Fig. 23).



Figure 23 Complete map of the island from the video game *Via Domus*.

An obvious and explanatory clue was “Geological composition of rocks likely to cause magnetic disturbances interfere with weather.” This clue could have been used with other information to explain why Flight 815 went down. It was confirmed in later seasons that the magnetic anomaly at that station caused the crash. Contrast this with the puzzle below that appeared on the show that lacked clarity—and for the passive viewer who didn’t





directed and authored from the central authority (Lindelof and Cuse 2007), this participation by an audience across media with the authors is a dance negotiating meaning and telling the story.

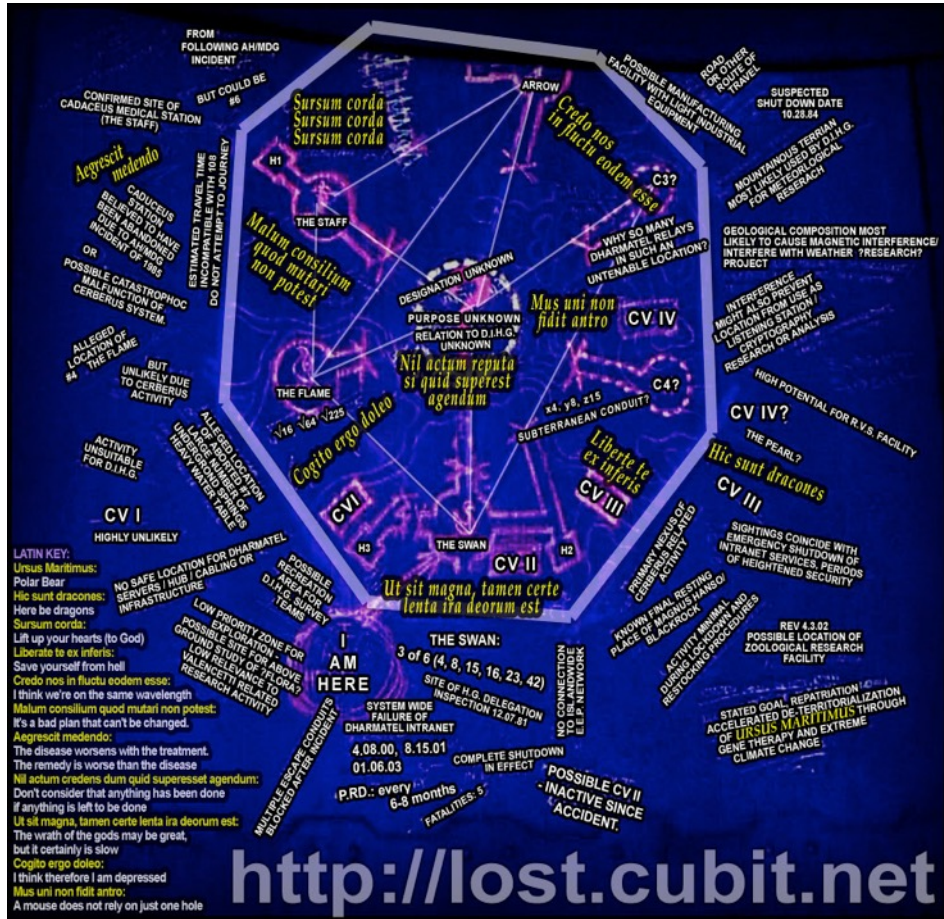

Figure 25 Fan decoding of map. <http://lost.cubit.net>

Gomez has the most forthright view expressed in Siobhan O’Flynn’s blog *Transmedia Camp 101*. “Transmedia development, production and implementation is a paradigm shift, (Siobhan O’Flynn 2010)” he asserts. “There’s a generation of people who are the most self-expressed. They’re already moving rapidly and seamlessly from one platform to the next; it’s almost instinctual. The problem is that their content isn’t doing that right now.(Siobhan O’Flynn 2010)” This comment unlocks the need for a design

method to tell a story that is across media but also employs the new digital affordances and aesthetics. We may be seeing a paradigm shift, and there are some amazing examples of how *Lost* has woven its stories across media, but *Lost* succeeds as a stand-alone TV drama. It has story threads and genres that give pleasure to the audience, so it underlines the “mothership” or West-Coast model with a core of movies, such as *The Matrix Trilogy*, or a television series such as *Lost*.

This core text provides emotional and myth-making closure for the big issues of science versus faith. In *Lost*, faith wins, at the expense of logic, stymying an audience of problem solvers and science fiction fans. It is the emotional logic that triumphs in *Lost* and delivered a complete experience on multiple levels for those participants open to it. However, there is media landscape of stories that cross and overlap and add meaning to *Lost* and turn it into a storyscape that is meaningful in ways that transcend the singular pleasures of the television show.

Bordwell and Thompson were proved wrong in suggesting that any lack of comprehension or closure would catastrophically deter the viewer or hinder the authorial vision. The conclusion of *Lost* was no more confusing than other long arc shows. *The Sopranos* conclusion, where the screen goes black with no substantial closure to the ongoing story arcs, is an example of a controversial ending to an open-ended story form without the trappings of transmedia to complicate the fans’ relationship. Both endings made audiences gasp—perhaps the exact response the creators desired to cement the emotional logic of the stories. In the blog *thelostflashbacks*, Josh Spivak (2010) emphasizes,

I start out by saying I'm into the mythology and science, and finish by saying it's all about faith. Faith? This from an agnostic. Well friends, that's one of the things that really shocked me. I thought I was watching for science fictiony coolness, and mythology filled revelations. Turns out I wasn't watching for that at all. I was watching because I connected with these characters, and their journey became my journey. As I said in the previous post, the show was never about getting answers to questions.

This is an ironical post since much of this examination of a storyscape has revolved around puzzles and logical explanations of events that strain our credulity. *Lost* at its center was a fairy tale, a fantasy, and a supernatural story. In the end, it is the emotional logic that matters, a logic expressed through myth and character gestalts of meaning and feeling and connectedness to the story outside of the media that contains it. Rather than a new paradigm we see an echo of an old paradigm shining through—*Lost* is still the “Heroes Journey” (Campbell 1968). Only this hero's journey is remediated and



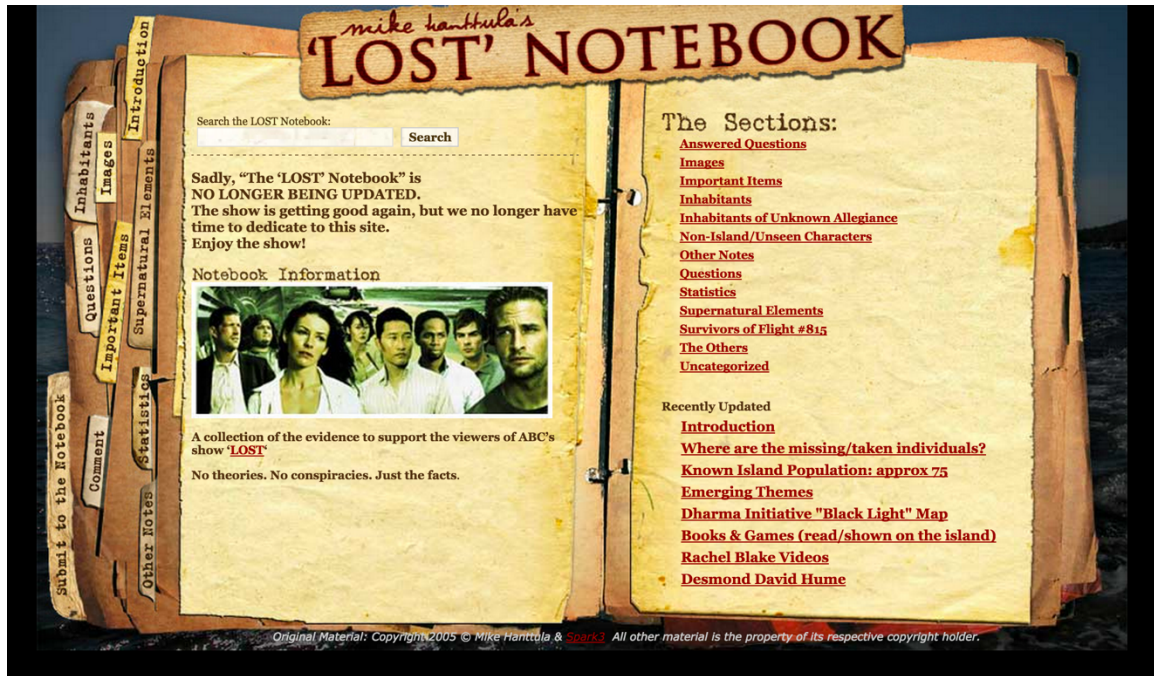

Figure 26 The *Lost* Notebook. Mike Hantulla. <http://www.hantulla.com/archive/projects/lost/> 2005.

spread across games, puzzles, and experiences so as to form an audience's hero's journey as they conquer the obstacles, solve puzzles, and explore the storyscape as seen in *The Lost Notebook* above (see Fig. 26) (Hantulla 2012). This is the participant's hero's journey, the first-person story without the Holodeck activated by the affordances of digital technology and reimagining the Aristotle's *Poetics* for a new medium, the storyscape.

Certainly there is a frisson of excitement in seeing the *Lost* webisode on YouTube discovered during the *The Lost Experience* where Jack's father Shepard Christian sends the dog to wake up Jack in a prequel to the opening shot of the first episode—a significant find that is seemingly relevant in puzzling out the mirrored shot at the end of the final show where Jack's eyes closed. This video confirms the viewers' belief in a supernatural element to the Island where Jack's father exists, alive and active, either as a

reanimated dead person (his corpse was in the hold of the crashed Flight 815) or as a dream person conjured up by the “Island.” While this seems significant, it doesn’t help resolve the audience’s understanding of the end with any greater finality. The creators have asserted the supremacy of the supernatural explanation in the storyline through a conclusion that is a religious experience that brings together all the characters—a resolution that invalidates detective work into causality for the Island’s mysteries and mythologies. The explication of the “sideways” world as a “purgatory,” as opposed to an alternate timeline, also resolves an interpretation favor of faith over reason—where all the characters convene in a church before “moving on” to heaven. So the transmedia information in this instance is both central and peripheral to decoding a structured story model for the television series. Nonetheless, all of these parts, explanations, and experiences—and the mental modeling in a participant’s head and by the meta-*Lost* audience who crowd-source meaning and use collective intelligence to understand the whole—create a storyscape that has immersion, catharsis, and continuing interest in character and mythology.

The entire transmedia enterprise proved to be largely peripheral to the emotional and intellectual experience of *Lost* because the television series was so dominant. It also fulfilled the storyscape definition of being stand-alone and works in the television medium without augmentation. Games and puzzles with clues ended up being less consequential to story comprehension and meaning making than to adding transmedia pleasures and affordances to the story (see Fig. 27 *Lost*, the board game). Media also suffered by being poorly executed; *Lost Via Domus*, the game was rated at 6.5 on *Gamespot* and 5.5 on IGN—failing grades. The problem of weaker transmedia support

also applies to Jenkins's example of *The Matrix*, where the two sequels are poorly regarded. The game and other supporting material was also considered weak, except the Animatrix animation DVD. Nonetheless, because of these qualities, and when looked at



**Figure 27** Lost The Game (board game).

as a storyscape ecology, a new paradigm for meaning making that affects individuals, groups—through combined authorship and crowdsourcing, and even culture as a whole, as it develops meaning structures of creation and exposition that are an order of complexity greater than available to storytelling previous to digital media.

The *Lost* storyscape was a meta-story that was greater than the sum of stories it comprised; it was a successful TV show, an amazing wiki-story with *Lostpedia*, a powerful participatory ARG, *The Lost Experience*, and a potentially enduring ecology of games, stories, and experiences to come: *The Lost* storyscape.



## CHAPTER 5

### DESIGNING A STORYSCAPE USING THE FOUR GESTALTS AND STORYSCAPE TOPICS AND AFFORDANCES

One describes a tale best by telling the tale. You see? The way one describes a story, to oneself or to the world, is by telling the story. It is a balancing act and it is a dream. The more accurate the map, the more it resembles the territory. The most accurate map possible would be the territory, and thus would be perfectly accurate and perfectly useless. The tale is the map that is the territory. You must remember this.

—Neil Gaiman, *American Gods*

#### 5.1 Introduction: Designing *The Ghost Club*

This chapter covers the design work and implementation of the four gestalts across a group of stand-alone media works. It also notes where principles and affordances were considered as part of the process. In the Appendix is a *Ghost Club* story bible that evolved from simple story pitch documents into a mythology documentation of the ideas and practice in the production of the *Ghost Club* storyscape. These documents chart the initial story bible and how the work was planned as a whole. The *Ghost Club* storyscape was based on the original West Coast franchise transmedia model. It also tested the noted affordances, provided an open model to encourage other participation and practices, and pushed as much work as possible into the public realm to encourage public interaction and explore the ecology of the storyscape.

In the storyscape of *The Ghost Club*, the authorial authority crafted a series of oppositional mythic structures with central conflicts, such as skeptic and believer, afterlife or not, and ghost vs. ghost hunter. We documented a history of events that illustrated these conflicts, such as the investigations of Harry Houdini and Sir Arthur

Conan Doyle as skeptic and believer, that acted as a core mythology documentation that was referenced and touched on by the various works noted. We developed a canon of events that took place beyond the stories and media but was explicitly referenced in certain works, such as the movie. These materials were shared with every production group for each medium.

We constructed roles and characters that could translate as abstractions across media or be represented by live action actors. These were revised and became canonical as the narrative exposition revealed in the works was expanded. This also was elaborated by additional character infrastructure that was created when writers developed backstories for the characters for expression in new works such as Twitter characters.

The whole work was situated with explicit genre configurations that extended from the ghost hunter genre, to haunted houses, to the pleasures of each medium. Horror and ghost hunting had genre conventions that were present in most media and this also made this a useful test case for research through design because of the prevalence of those genre paradigms and references.

*The Ghost Club* storyscape was conceived as a whole embodying the four gestalts. Movies, webisodes, games, and participatory platforms were proposed as an ecology in the first pitch document and referenced the usefulness of this genre and topic for its establishment across the known media platforms used by *The Matrix* and *Lost* storyscapes. The horror genre also leveraged a simple set of pleasures—fear, surprise, disgust, suspense, and comedy—to explore across the media works.

In our design work, we planned movies, webisodes, Twitter novels, Twitter characters, a wiki (*Ghostpedia*), multiple connecting websites, flash games, and an

iPhone augmented reality game. What is discussed below is the work that has been created to test the theoretical models for design methods. Each work is in a different stage of completion, but everything listed below has at least a working demo. A portion of the work is still available in the public domain including a feature movie, webisodes, an AR game/app on Android, websites, Twitter characters, a Facebook page, and documentation of the participation platforms such as *Ghost Club University* videos. Table 2 (Table 2) below represents the first round of media works and how the four gestalts would map across each medium and was developed during the Argon AR game (Blumenthal and Xu 2012).

In the beginning, these were framed as connectors that were not present in every medium, but subsequently they were reconceived as gestalts that modeled the whole work, as presented in Chapter 2. Seen as a whole in this chart, these gestalts as an organizing method stand in opposition to the other principles extolled by Jenkins (2007b) in his *Transmedia 101* primer and its further elaborations. The chart shows how the four gestalts works as unifying whole individually through a participant's experience with multiple media and collectively to convey a coherent whole, not simply as canon as Long asserted, but mythically/ideologically, through character, and with genre fleshing out the story.

Much of the design process was drawn from the individual media fields, but the overall design of the storyscape was planned in advance to take advantage of the four gestalts to create stand-alone elements that explicitly or implicitly referenced one another.

**Table 2. This table represents the specific components designed across the storyscape.**

**TABLE 2**

**DIFFERENT MEDIA AND THEIR IMPLEMENTATION ON FOUR GESTALTS**

	Mythology	Canon	Character	Genre
Movie: <i>The Ghost Club</i>	Skeptic vs. believer; Club history	Main story events	Austin, Caitlin, Jimmy, Noreen, Parnell, Tab, Ghosts, Stanley	Ghost stories, Horror, Science Fiction
Webisodes: Ghost Club Girls	Club history Skeptic vs. believer	Prequel Backstory	Caitlin, Noreen, Tab	Ghost stories
Website The Ghost Club	Skeptic vs. believer		Roles: Psychic, Archivist, Sr. Jr. Technician	
Ghostpedia	Skeptic vs. believer		Roles: Psychic, Archivist, Sr. Jr. Technician	
Website: TGC The TV Show	Skeptic vs. believer; Club history	Main story events	Austin, Caitlin, Jimmy, Noreen, Parnell, Tab, Ghosts, Stanley	Ghost stories, Horror, Science fiction
Flash Game:	Skeptic vs. Believer			
Flash game: Ghosts R' Us	Collection evidence and devices (FLIR, EMF) Apparitions, orbs, (not blood)	No canon	Character abstractions are used as cartoons and are consistent with the feature film.	Metaphors of horror genre
Mobile AR Game: Ghosts vs. Club	Ghosts vs. Club Scientific Methodology of the Ghost Club The EMF meter The FLIR camera	No canon (acting out of canon)	Roles are used: Leader, Psychic, Tech, and Scientist. These roles are consistent with the feature film.	Horror: ghost appearances and haunting

Within the design process of each individual component, the teams brainstormed how to best connect and express the central mythology and other gestalts while simultaneously looking for a design that maximized the most efficacious expression of the pleasures of that platform. We were constantly looking for not only plot connections and visual brand expressions that would normally be part of an additive extension of a franchise but also ways to extend the myths and all modes of character while serving canon exposition and genre parameters.

Once the connecting design elements were described for each platform, they were recorded as part of our documentation and continually reexamined to determine maximum confluence. These implementations were reviewed granularly down to the procedural bias of the code as a storytelling medium. For example, teams were questioned as to whether the core myths and story structure was being distorted by the code that was created or reused in building these works.

It may bear reminding that the four gestalts differ markedly from other theoretical methods of transmedia storytelling. They place different emphasis on the type of connections and the completeness of the individual works. Since this approach explores the relations between stand-alone works, we put aside the ARG approach of ubiquitous games as insufficient to test our gestalts against discreet media. Christy Dena's (2009, 47) approach to transmedia storytelling focuses on her term *distinct media* to "encompass a variety of media beyond the traditional notions of television, cinema, books, and so on; and to likewise differentiate these practices from multimedia within a media platform." This differentiates it from the research of gestalts used in a unified storyscape design process. Henry Jenkins (2006a) references the plot or extended story of

transmedia storytelling, and while *The Ghost Club* designs follow Jenkins's models, the goal was to define relationships that are sometimes intangible and connect affordances and media that seem unconnected. Representing a further remove, some critics criticize transmedia storytelling as simply "additive" by providing adjuncts, mostly marketing exercises, to central texts and not being a new model or whole and thus occupying a transitional place in the evolution of an interactive storytelling model. This storyscape ecology posits the development of whole work with a unified authorial control.

This storyscape was conceived as an ecosystem where participants would be encouraged to explore the various media through links and connections, participation, and a web of social media instances that were readily accessible including Facebook and Twitter.

*The Ghost Club* bible acted as a unifying document and as each new work was added additional materials were added. This included ideation, research, and design documentation. In the case of the Flash games and websites, Capstone groups created extensive project documentation that charted the four gestalts from ideation through completion of a demo or launched product. The design requirements were to use the four gestalts as a method, with due consideration of storyscape affordances. As additional media was produced and released this also resulted in a visual canon that was referenced, or reused, to further enhance the gestalt conception of a whole storyscape.

Before discussing the individual efforts and summarizing what was learned through the process and examination of the documentation, the following notes gestalt qualities that were shared with all production participants:

### **5.1.1 Myth-Making and Mythology Documentation**

1. Do we live beyond our mortal state and are we able to communicate with the dead? Pro and Con.
2. Skeptic vs. Believer
3. Ghosts vs. Ghost Hunters
4. The history of *The Ghost Club* storyscape is grounded in the use of the real historical Ghost Club. This was exemplified by Sir Arthur Conan Doyle, who was a debunker of supernatural in his Sherlock Holmes works but a devout believer in ghosts in life. His opposite was Harry Houdini, who was a public magician and a great skeptic in his private life. Doyle, a Ghost Club member, and Houdini, who was not, investigated paranormal activity in real life. In our revised history, they were both founding members.
5. Liminal and threshold metaphors and events that contrasted ghosts as between two worlds.
6. Five eras of the Ghost Club with different technology were laid out.

### **5.1.2 Character**

1. Embodied characters, actors, were represented across media where relevant. Even bit players including ghosts were employed in AR ghost hunts. This was also a production technique to leverage high production green screen footage.
2. Archetypal or generic characters were employed in games and other media that inferred you were playing one of the embodied characters but only sketched out core physical or dramatic attributes. This is similar to the *Lost* video game, where you could play an avatar that was a generic version of Jack Shepard, a doctor and one of the leaders of the survivors.

3. Roles, including Leader, Tech, and Psychic, were implemented for games and participatory platforms, such as the Theatrics LARPing/ARG platform. (LARP is live action role-playing.)
4. Characters had arcs within each work, but those arcs also extended across media in the case of the movie and webisodes.

### **5.1.3 Canon**

Our goal was to maintain a consistent canon, as Long (2007) suggested. This was accomplished through documentation and human story bibles that reviewed each new work in progress.

### **5.1.4 Genre**

The horror genre dominated all the media. It has specialized emotional states. Our design focused on surprises or cat scares, suspense, satisfaction of genre expectations regarding horror tropes, and disgust.

1. Gore and disgust were addressed very lightly as a conscious choice.
2. The ghost-hunting television show genre has its own genre expectations and organization to the shows that was used.
3. Movies and games had a history of the horror genre implementations that were leveraged.

### **5.1.5 Ecosystem**

1. The building of migratory cues into the movie and other work was meant to encourage exploration across the storyscape.



2. Basic promotional links to additional content in other media were used to drive participants to the whole work.
3. Platforms including Theatrics.com, Facebook, and our website were used to aggregate content and release it as a single work to those audiences.

### **5.2 Movie: *The Ghost Club: Spirits Never Die***

The first movie in *The Ghost Club* storyscape is *The Ghost Club: Spirits Never Die*. It is about a team from The Ghost Club that investigates ghosts on a (fictional) reality television show. After returning to a previous investigation, they get more than they bargained for and are confronted by ghosts. The movie was completed in 2014 and is currently in distribution on digital platforms including cable VOD, Amazon, BigStar, Vudu, Playstation, Epix, Hulu, and more. The motion picture was created first. The advantage of doing a feature film first is that it helps elaborate an abundant set of myths, canon, characters, and explores the genre. This is an approach similar to the way *Lost* and *The Matrix* used serial TV and movies to lay groundwork for other media elements (I. Askwith et al. 2007). *The Ghost Club* storyscape was not planned as a “mothership” model with a central text of movies and television. Each part was conceived as an equivalent entrance point. Nonetheless, this schedule generated myths, characters, canon, and design assets that were leveraged for subsequent works.

The movie articulates many of the aspects of the storyscape gestalts. The mythic opposition of skeptic vs. believer is elaborated, referred to, and acted out. Symbols and predominant themes are introduced. The embodied characters are introduced with roles that we would abstract in other media as roles or generic character traits. Mythology is included through the exposition that unfolds in the movie, referencing skeptics and

believers or Doyle and Houdini. The movie also creates a large body of canon through the unfolding action and serves as a canonical reference for the other works. Further, the movie situates itself within two straightforward genres: the science fiction/horror genre and the subset of the ghost-hunting reality television show. The movie becomes canon in the storyscape and these genres are applied where possible in each subsequent medium.

The gestalts of myth-making, character, and genre were readily integrated in the movie-creation process because within this medium they are legacy methods for storytelling. Central conflicts drove the story forward toward resolution of the conflict between skeptics and believers. Actors embraced their roles as skeptic or believer as much as the character roles of leader, psychic, or technician. The horror genre set a series of expectations to be fulfilled or revised. This is despite a conception that extended beyond the single work to subsequent movies, including an origin script about Houdini and Doyle's first investigation that was drafted as the next installment. This method also anticipated the exploration of these gestalts across media and was constructed to address the different media engagements of a storyscape. For example, the act of ghost hunting illustrated below (Fig. 28) and the procedures used are repeated in the movie, AR games, and participatory platforms.



**Figure 28** In this scene from the movie actors are seen having encounters that can be duplicated in other audience participatory media.

### **5.3 Webisodes: *The Ghost Club Girls***

The first webisodes are a prequel web series that follows the three principle female characters of *The Ghost Club* starting a year before the movie in the fictional timeline. In the sequence of three webisodes comprising “Interviewing a Psychic,” two women from the movie meet the third team member for the first time under odd circumstances. The photo below (Fig. 29) shows the web series on the main Ghost Club “television show” website. It was also posted to YouTube and released with tweets and Facebook posts over the course of a month. *The Ghost Club Girls* (GCG) was also re-released as part of our Theatrics.com participatory platform with all the content re-scheduled across the ecosystem for a release before the cable VOD platform started.

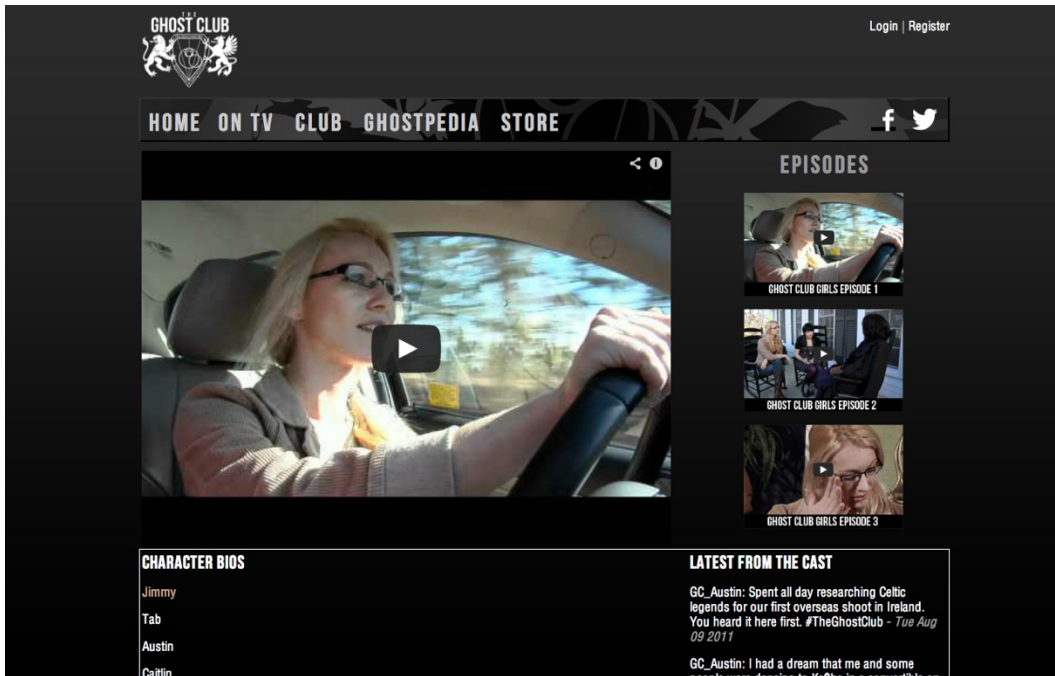

Figure 29 *The Ghost Club Girls* web series on the TGC site and also YouTube and Theatrics

The webisodes are coequal with the movie in that they share the same mythology, canon, genre, and some characters and are meant to provide a valid point of access to the storyscape. The webisodes extend the approved canon through the extension of the movie's plot thread. It gives additional information that may enrich the movie experience if known in advance. If seen first, the viewer knows that one of the investigators is a journalist out to expose them as frauds and that when Caitlin is around she causes psychic problems with ghosts. The webisodes were released a year in advance of the movie and introduce the female characters. It is the first, or origin story, in which we meet Caitlin, the psychic lynchpin of the movie. In the webisodes, correlations between the gestalts and plot causality were designed into the story. The following graphic (Fig. 30) shows the early planning for how plot and character would unfold across media in an attempt to build an ecosystem that participants would explore. The intention was there would be multiple web series as well as building a base of character fans through character Twitter

and Facebook accounts that were in the first person and were meant to allow an audience to talk with the characters.

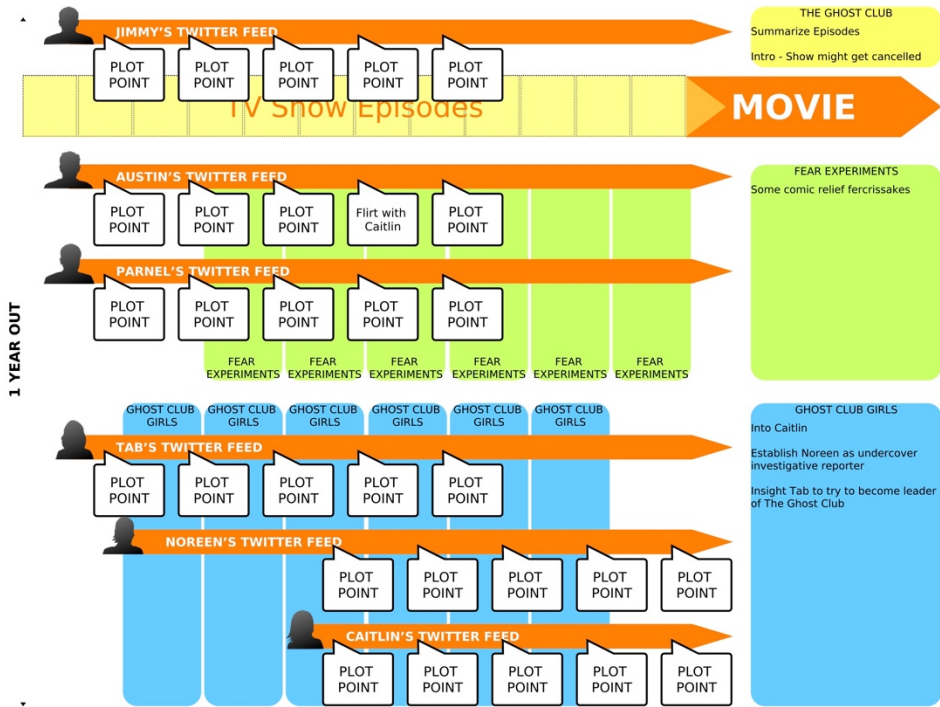

Figure 30 Early diagram of character arcs, plot arcs, and media timelines. Jason Nunes and Hank Blumenthal. 2011.

The *GCG* webisodes were written and produced after the feature movie and included the same actresses. They were written and directed by one of the crew and submitted to the authorial group for approval. They were recognized as canon so small changes were made in the script to conform to the story bible. Another series was written but never produced that involved a first-person account of a haunting investigation. Despite their promotion and publication in multiple places, the shows were rarely watched and contributed little to users' understanding of other media. There was not enough promotion to bring in an audience and the web series was discontinued after three episodes because of the logistical costs of creating and promoting more content. I will

return to the logistical and practical problems with making a storyscape with limited resources, as outlined in my summary at the end of this chapter. Nonetheless, the webisodes introduced characters, set up additional story lines, extended the mythological background, and indicated how the story could be expressed through alternate media extensions. It also provided another entry point to the storyscape.

## **5.4 Augmented Reality Stories and Games**

Augmented reality stories were designed and created as part of the *Ghost Club* storyscape from the beginning. The intention was to create an interactive narrative experience that would work as an iPhone game. It would drive the participants together to collect evidence of ghosts in the liminal AR world of mixed reality while encouraging participants to immerse themselves in roles and problem solving as a ghost-hunting team. The roles and methods were mirrored in the movie and other media. The following diagram illustrates how that flow was intended to create team interaction to discover evidence. The design documentation reflects this thrust but despite multiple implementations of AR games on smartphone, the production teams were only able to execute simple interactions for single players. Myth, character, genre, and canon gestalts were integrated and used as design principles to good effect despite limitations. Following is a discussion of the multiple iterations of this platform.

### 5.4.1 Mobile AR Game “Ghost vs. Club”

The goal of the augmented reality (AR) game “Ghost vs. Club” is to allow participants to enact the narrative paths that are outlined in other fictional and game narratives. Participants can take on the roles of *The Ghost Club* and use their own mobile phones to investigate an augmented reality world that blends the physical space that we

live in with digital ghosts. The characters designed for mobile AR game are the roles of the team, including leader, psychic, tech, and scientist, which are consistent with the feature film characters. The diagram below indicates how the team would be given role-specific information that sent them down separate paths that merged and interacted to solve a location-specific virtual haunting and then collect and post evidence.

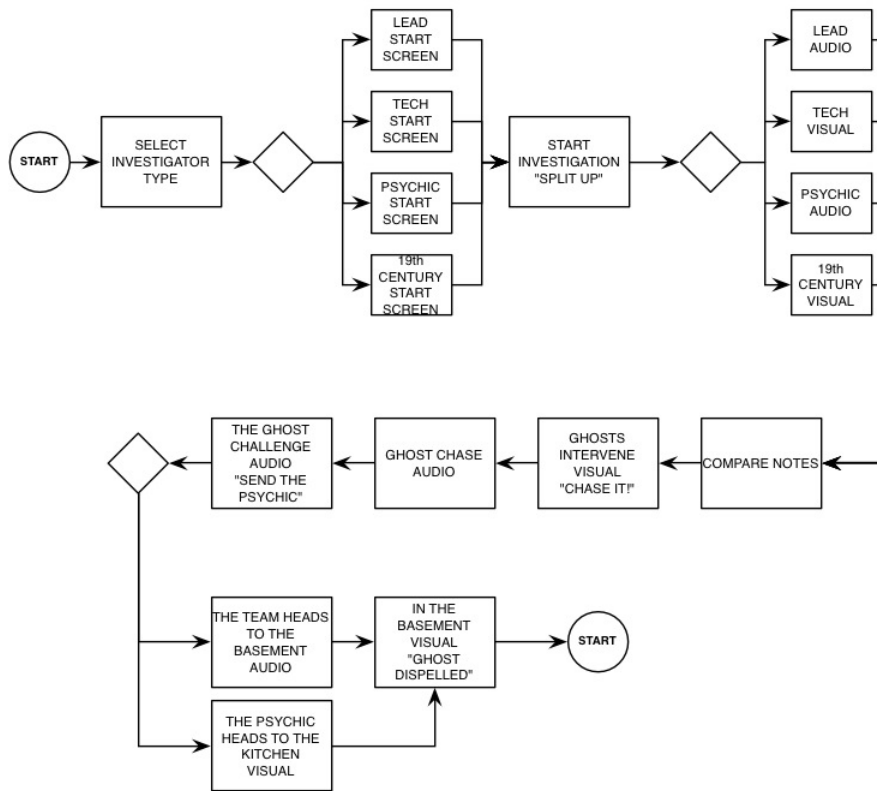
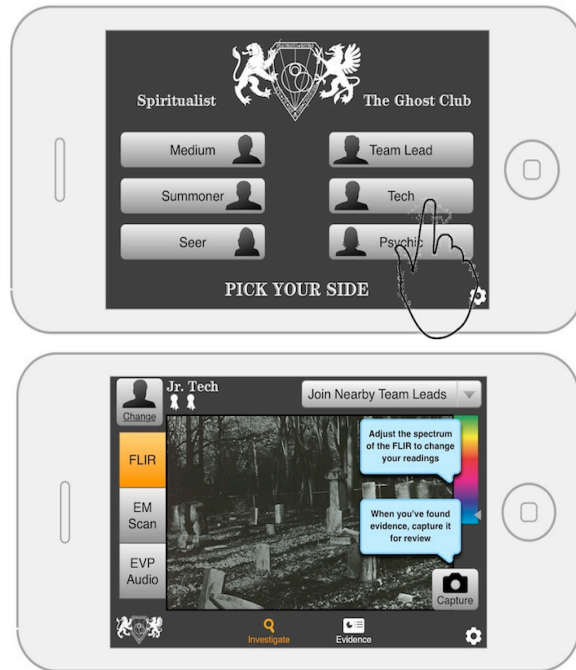

**Figure 31** Diagram showing multiple user story interactions forcing collaboration across a linear story path.

The AR game is about implementing a physical reenactment of iconic events that occur in the movie and historical ghost club investigations. It draws on roles and asks for participants to connect with devices related to their roles. The psychic interface, chosen at the beginning of the game, will have a B-Chan while technicians will have a variation on FLIR meter that allows them to cycle through color filters to reveal virtual ghosts. The participants form ghost-exploring teams, hopefully, outfitted in Ghost-Punk clothing to reflect the brand aesthetic, and proceed to locate ghosts. Proceeding from GPS coordinates to the tools described in the mythology and canon, they attempt to capture evidence and hear a story of how these ghosts ended their lives. Certain genre qualities such as spooky places and surprising jump scares further connect this experience. It should be noted that these genre qualities and rules have been documented in the mythology to encourage immersion as a whole system. For example, vampires are out of place in ghost stories unless the mythology has taken account for how their histories and supernatural powers interact and complement the genre model.

A simplified version of these interactions is shown above. It demonstrates the selection of specific character roles. Then it mocks up a single device that connects the ghost genre, the movie, and a form of interaction for augmented reality storytelling that emphasizes the liminal quality of ghosts. Using a color filter and adjusting the setting would reveal ghosts surrounding the participant (Fig. 30). That could then be captured as





**Figure 2.** Design of the wireframe for the mobile AR game. **(Top).** Choosing the role in the game. **(Bottom).** The screenshot shows hunting the ghost in the wild. It uses real-time video taken from the camera as the background.

**Figure 32** Illustrated wireframes showing the basic features and controls. Upper corner is the role choice and badges. Each role would have customized ways to collect evidence or information seen on the left. The complete version is in the Story Bible appendix.

a photo. The following image shows a participant capturing a photo with a ghost (Fig. 32). This was the most well-liked feature of this app. People had a takeaway of themselves with a ghost that could be effortlessly emailed to them.



**Figure 33** Screen capture of the app showing the revealing of the ghost with a participant. The ghost was also present in the feature film and other media.

As can be seen in the above photo (Fig. 33), participants could press the different color buttons and pan around the space to reveal the ghost. The ghost was also the same as used in the movie and subsequent AR games. The platform used was Argon, an AR platform developed at Georgia Institute of Technology by Blair McIntyre. It was an excellent demo program and lived in the iPhone app store during our demos, allowing easy distribution. Nonetheless, lag and resources to develop more complex functionality limited our use to demo environments. This led us to a version on the Haunted Planet platform.

#### 5.4.2 Augmented Reality Game: Haunted Planet

The Haunted Planet versions of the Ghost Club AR app leveraged as much as possible the previous interaction design and representation of the four gestalts where

applicable. Once again complex interactions to create a multiplayer interactive story were not able to be fully implemented because of resources and time. However, there was a robust interactive system that was already in place to support works that were ghostly or historical scavenger hunts. Narrative uses of AR are often used as a way to show a past history and ghosts (Azuma 2015). This exploration of the past has ghostly overtones and was useful as a feature set to build the ghost-hunting routines of the genre.



**Figure 34** Locating ghosts up to 300 meters away using the Haunted Planet AR app.

The Haunted Planet app provided useful ghost-hunting methods. These included seeing ghosts on a dynamic locally generated or geographically static map (Fig. 32 and 33). The user could use the GPS function to navigate to the ghostly area where a second interface using the camera helped the viewer navigate to get the ghost in view with indicator arrows to assist.

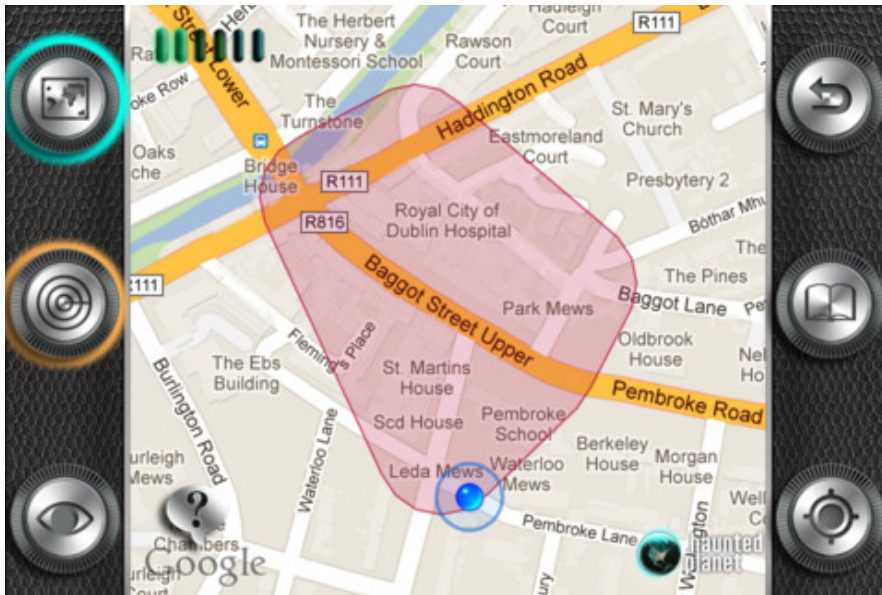

**Figure 35** The ghosts inhabit the red highlighted area.

Audio also added narrative information, closeness to the entity, and another tool to access the genre with ghostly sounds and noises. Once a ghost was in sight, the camera could be used to capture an image of the phenomena. This then defaulted to a scoring page that allowed the skeptic or believer participant to confirm or deny the evidence against the app results. This would confirm or deny the evidence as real, false, or unknown.



**Figure 36** An example of capturing evidence. A skeptic result—in the summary it is revealed as a wisp of smoke.

The Haunted Planet version is still working on Android and has been released with press kits including all the currently available aspects of the storyscape. It was on iPhone and then Android and was copromoted across all other media including social and participatory platforms. *The Ghost Club* team built multiple variations. There were two main versions. One was a *Ghost Club* version that embodied the character, genre, and canon while another extended the rules to apply to a ghostly student leaving messages on the Georgia Tech campus that is revealed through the app. A specific version was created to compliment a talk about *The Ghost Club* and transmedia storytelling art the Atlanta Film Festival. Ghosts were located around all the festival's venues, and the application would allow you to seek out and capture them as photographic evidence (see Fig. 34).

As implemented the AR applications were most effective in complementing the storyscape through the invoking of the ghost-hunting tools and methods represented in

the reality television show subgenre of horror. Attempts to implement roles and connect to canonical events were limited. Nonetheless, both skeptic and believer played out as mythic game mechanics even in this simple execution. Another opposition of ghost versus ghost hunter was not implemented despite many ideas on how this could provide an online/offline dynamic of ghost against club.

### **5.5 Flash games: *TGC I* and *TGC II***

Two versions of a flash game were developed using Capstone groups at the Georgia Institute of Technology. Addressing the four gestalts, the design focused on finding ways to integrate them into the experience of a genre of goal-directed games. The narrative lived outside the games but was referenced through our design that represented the core myths, roles, canon, and subgenres. There was a consistent attempt to reference or repeat narrative situations. In the *Ghost vs. Club* game, it was explicitly an attempt to recreate a similar experience as the characters repeat in their ghost hunting.

There were two games developed into a demo mode. The first game, *TGC I*, involved teams of ghost explorers investigating game levels of a haunted house. They were searching for the tools and devices used throughout the ecosystem and defined in the canon of *The Ghost Club*. The player acts as a ghost throwing cold spots, hot spots, and orbs (part of our documented mythology) at the ghost explorers, exhausting their “health,” and stopping them from collecting devices that help the investigation. These devices, the same as are used in the movie and web series, included real ghost-hunting tools such as an EMF (electronic emissions) reader and a FLIR (heat maps) camera, but also included our made-up devices. The B-Chan measures psychic ghost emanations and is used by Caitlin, the psychic, in the show/movie. These devices were represented as

abstractions, and the goal of the ghost explorers is to collect the devices and use them to get “evidence” of the ghosts and win the game before they are all turned to ghosts. In addition to providing mimetic experiences that echoed the narrative actions in the stories, key symbols and indirect mythology are consistently evoked. Ghost Explorer design echoes the archetypal physical characteristics of characters in the movie, and the mythology of the haunted house is referenced. The *TGC I* flash game gives users the ability to place themselves in opposition to the Ghost Club and use the affordances of the level and health-based game genre to engage the core story elements expressed through the four gestalts.

In the illustration below (Fig. 37) the first level is depicted where the four cartoon ghost-hunter roles are depicted as exploring the first level to find their evidentiary tools to win the game. The participant, seeing the struggle from the ghost perspective, uses hot, cold, and orbs to incapacitate the avatars, like the movie and ghost-hunting genre.



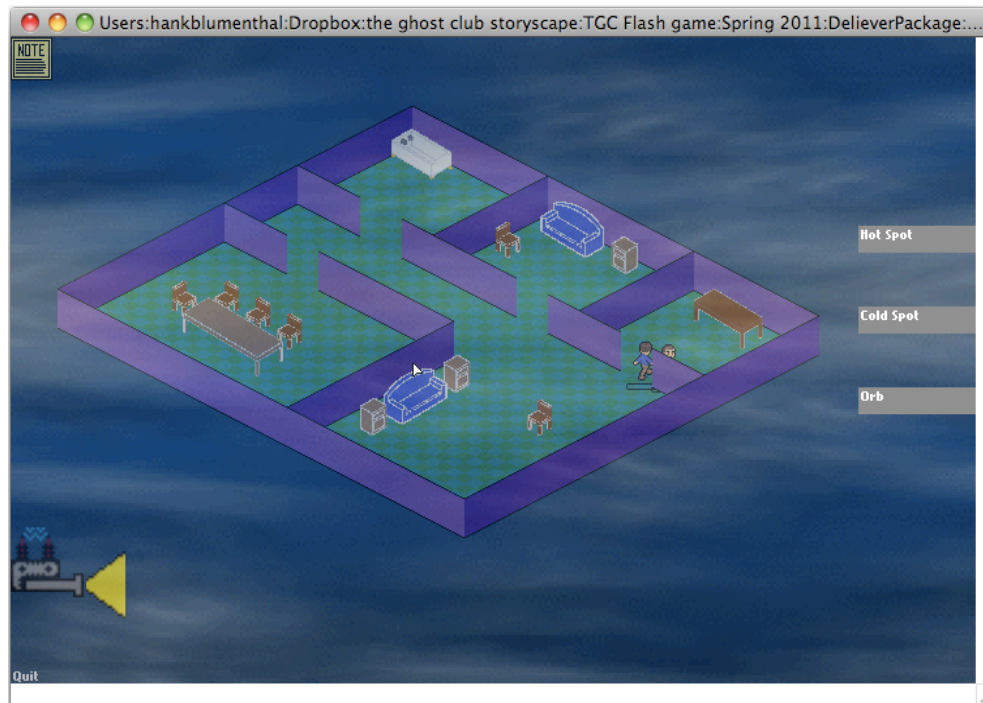

**Figure 37** *TGC I* showing device and ghost explorers going through the mansion level.

The second flash game demo (*TGC II*) was based on a detective model flash game where characters go through static rooms and ask questions of characters to solve a mystery. This echoes the mythology of *The Ghost Club* that hinges on discovering why a place is haunted, how it ties in with objects, and evidence. Exploring an archetypal mansion that is set in the *Ghost Club* Diesel era, an explicit subset of our backstory mythology documentation connects the *Ghost Club* storyscape across time. This is to explicitly correlate to Sir Conan Doyle and Houdini, who act as archetypes of the skeptic and believer of that time period.

The core skeptic/believer myth drives the core discovery of this work. Like a Sherlock Holmes story, each revelation leads to a logical or supernatural resolution. The characters are part of a larger archetypal construction across the storyscape, and the canon is likewise represented in the mythology documentation. Specifically, the



representation of the multiple eras of *The Ghost Club* storyscape that were mapped out but are only seen in the story bible and alluded to in the works. This includes verbal exposition in the movie and web series and foundations for extensions within the storyscape.



**Figure 36 TGC Detective Game in the Gaslight Era of Doyle and Houdini.**

These games were developed separately by autonomous teams. They were vetted by the authorial authorities but were developed in an open ideation process. Teams were given access to the four gestalts as a primary model to leverage, the story bible, and all extant works and materials. Based on that research, they proposed games that fulfilled specific game models that were well established. The first ghost-hunting app was similar to first-person shooter and ghost-hunting games that used cameras instead of guns. The second was based on a popular flash game detective genre. Both melded with the storyscape genre and experiences but also satisfied the storyscape medium. Each would

work as a stand-alone work with a distinct pleasure of a flash game model.

### **5.6 Websites: *Ghostpedia*, *The Ghost Club*, *TGC on TV***

The websites for the *Ghost Club* storyscape represent examples meant to encourage user participation and take the fictional aspects of the storyscape and connect it to a noncanonical participant extension. The websites were meant to reinforce myth, character, canon, and genre through the participation in an ecosystem that connected these gestalts into a whole. It rested on the principle of verisimilitude, mixing reality and fiction, through its depiction as the website for the fictional TV show, *The Ghost Club*. It featured information about the show and characters (those seen in the movie that was an episode of the show). Facebook and Twitter feeds into the site also contributed to promoting that reality and were set up as TV show press feeds. Actors' Twitter accounts were connected, and they tweeted in character as their on-screen fictional characters. *The Ghost Club Girls* series was promoted on this site as an advertising spin-off from the show, much like the *Lost* ARG's released content between seasons. The Clubs were set up as a participatory mechanism and the *Ghostpedia* as a resource and result of the clubs. And of course merchandise. The photo below (Fig. 39) shows the home page of the website.

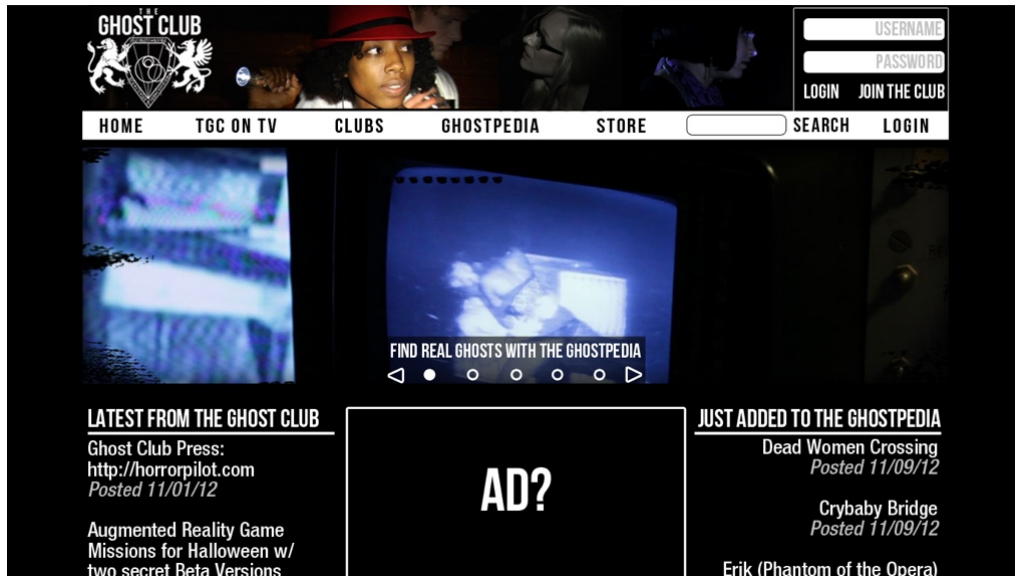
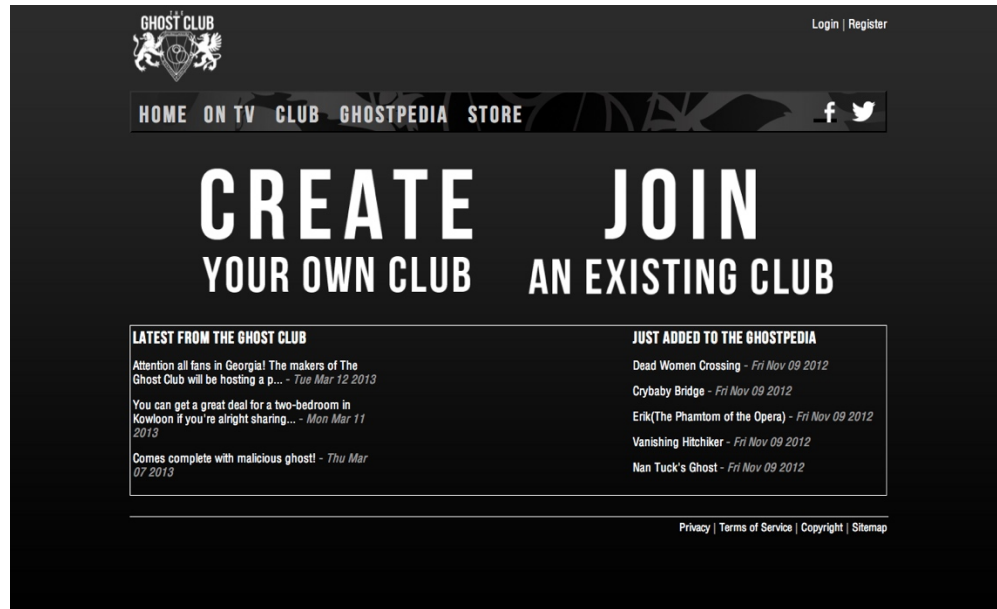

Figure 37 *The Ghost Club* website.

*TGC on TV* is a subwebsite that is a version of what the fictional TV show's website would look like. It mirrored other ghost-hunting show websites in functionality. It has direct feeds from the actors' Twitter feeds, updates from the fictional show, fake episode guides, and other canonical links such as the webisodes and TV show clips (from the movie).

*The Ghost Club* "Club" website was to foster participation for ghost explorers meeting in the real world to do investigations as groups and posting the evidence they collected. It allows individual and group pages to be created as well as posting of evidence. You could find like-minded individuals in your area, and it provided a forum for meeting and posting. You could create a club or join an existing one (Fig. 38). After you went on ghost-hunting expeditions, you could post your evidence to the *Ghostpedia* and allow other members to comment and evaluate its veracity. This leverages both the central myths but is also to encourage a re-enactment of the methods and stories in

passive media. It opened the door to a noncanonical participation and practice that can feed back into the authorial productions. In *Lost*, as I noted previously, fan participation and opinions, impacted the storyline through the elimination of two detested characters.

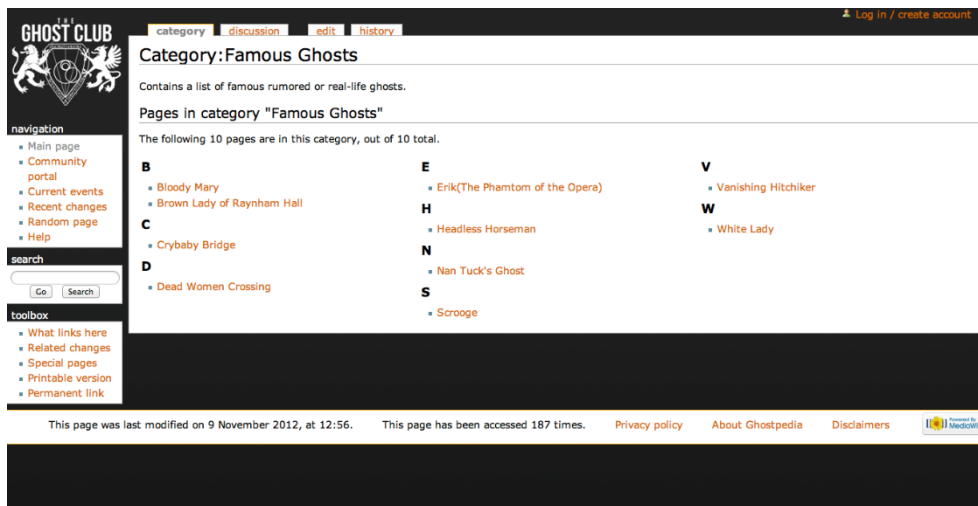

**Figure 38 Participatory section of the site: Be a ghost hunter and join a club.**

Further, ghost hunting was ripe to be encouraged as an entertainment activity. Research into ghost-hunting groups discovered that they were both territorial and exclusive since real hauntings were scarce and groups wanted to be taken seriously. Nonetheless, participation was nonexistent despite attempts to promote locally on campus. The functionality constructed on the website was never fully completed because of lack of use. This participation feature of the storyscape that was intended to investigate the performance elements was realized subsequently using the Theatrics.com platform. These will be covered below.

### 5.6.1 Ghostpedia

The *Ghostpedia* (Fig. 39 below) was to contain all nonfictional ghost information about haunted places, evidence collected by the club, and general ghost-related supernatural information. Evidence accumulated by the groups was supposed to provide increasing content. It is a resource that overlapped the interests of the participants with the storyscape to engage the users as much as the casual observers or a larger ghost audience outside the storyscape. It was seeded with famous haunted locations and ghost stories but was never embraced by participants. Constant spam issues eventually forced the team to close it down because of maintenance requirements. Another *Ghostpedia* was created on the Wikia site as a co-production with the Theatrics.com launch and a Wikia Theatrics.com collaboration. It was unused by participants.



**Figure 39 Ghostpedia. Pre-loaded with haunted spots and vocabulary.**

### 5.6.2 The Ghost Club Store

The store never existed as more than a stub but it featured real props, logos, and other paratextual artifacts to connect the audience with the story works.

## 5.7 Social Media

Social media for the *Ghost Club* storyscape was constructed to address two needs. The first was to use the media to build communities and disburse information across those groups. The goal was to use it to create a passive and participatory ecosystem that encouraged users to experience the works they were most interested in while perceiving the whole of the story as extending beyond a single work or form of engagement. The second need was to encourage an ongoing narrative and interaction with the characters through a mixing of fictional stories embedded in real-world media. This was made up of characters and *Ghost Club* TV show accounts on Twitter, blogs, and Facebook. All of these instances provided migratory cues to all the other works of the storyscape.

The most successful version of the characters was Jason Nune's character Jimmy. He had an active Twitter account and blog (Fig. 40 and 41). He attracted interested users and was able to interact with participants in our storyscape and recruit others to the ghost-hunting storyscape. In addition, he created a comic about Jimmy's adventures that was published on his blog. There is an example below of one of these comics. They worked consistently to express the myths, character, and genre of the storyscape. Jason was one of the cowriters and cocreators of the creative material so he was well placed to expand on the gestalts.

phasmatis•norma

**Jimmy Martin**  
@GhostClub\_Jimmy

I drink bourbon, and hunt ghosts for a living. What's better than?  
Brooklyn, NY. http://ghostclubusa.com/

29 TWEETS    36 FOLLOWING    16 FOLLOWERS    [Follow](#)

### Tweets

 **Jimmy Martin** @GhostClub\_Jimmy 29 Oct  
Watching The Fog and weathering Sandy. It's a ghostly weather kinda afternoon.  
[Expand](#)

 **Jimmy Martin** @GhostClub\_Jimmy 24 Oct  
Photo: [tumblr.co/ZOYa8uVuHmUx](http://tumblr.co/ZOYa8uVuHmUx)  
[View photo](#)

 **Jimmy Martin** @GhostClub\_Jimmy 18 Oct  
Brilliant! Beau Lotto + Amy O'Toole: Science is for everyone, kids included | Video on [TED.com](http://TED.com) - [ted.com/talks/beau\\_lot...](http://ted.com/talks/beau_lot...)  
[Expand](#)

 **Jimmy Martin** @GhostClub\_Jimmy 16 Oct  
Photo: [tumblr.co/ZOYa8uVP7NRp](http://tumblr.co/ZOYa8uVP7NRp)  
[View photo](#)

 **Jimmy Martin** @GhostClub\_Jimmy 15 Oct  
666 Park Ave should be called 666 derivative, boring, bleah, I can't even be bothered to come up with a proper insult Avenue.  
[Expand](#)

 **Jimmy Martin** @GhostClub\_Jimmy 15 Oct  
Get your hunt on: Take A Tour Through The City's Most Haunted Places - [huffingtonpost.com/2012/10/14/san...](http://huffingtonpost.com/2012/10/14/san...)  
[View summary](#)

Figure 40 Jimmy Martin's fictional Twitter account.



Figure 41 Skeptics Diary comic strip online.

Caitlin, Noreen, Parnell, and the caretaker's girlfriend also had Twitter and Facebook accounts as the fictional actors in the reality television show. They had scripted tweets that were posted to interact together and with Jimmy. The lack of a robust community for the storyscape and promotion hindered this effort. Logistics, including writing, posting, curating, and maintaining, was the main obstacle as the intention was for the actors to maintain these accounts with support from our writing team, but they did not have the time or producing supervision. Freelance writers contributed additional backstories and materials to be released across social media in pieces and as part of extending the characters' arcs and backstory. Hidden cues and links to other storyscape media were also embedded.



Facebook and Twitter were built as a central clearing house for our community. They were represented as the social media sites for the fictional TV show and the backstory of the Ghost Club laid out in the story bible. Links to all YouTube videos, comic posts, characters, games, events, and all other material appeared in these places. An example of the Facebook page can be seen below. Additional social media included a Kickstarter campaign and a YouTube channel that were used to distribute content and archive it. In the following, the Theatrics.com platform will be discussed and these platforms were used to publish and archive that original content too. In recent months, after the Theatrics.com site was closed down, the sites were repurposed as general promotional tools and the fiction that they were for the fictional *The Ghost Club* TV show was abandoned.



Figure 42 Ghost Club Facebook page

## 5.8 Theatrics.com

Theatrics.com was a website and toolset created for transmedia storytelling. It supported multiple interactions but was set up to encourage the creation of fictional characters as part of an unfolding transmedia story or ARG. Nick Martinez, a well-known transmedia theorist and pioneer, connected us and supported our developing and porting our content to this system as an example of its potential. This provided an opportunity to focus our community and ecosystem in one place for dissemination. It supported a re-imagining of *The Ghost Club* “clubs” using the features to create characters, post video and images, and interact with other participants.

To support this platform, we created a schedule to re-release the games and videos that were previously created as well as the comics and other character interactions. A series of introductions to the theatrics platform and stories were produced in video and also episodes of the *Ghost Club University*. The goal was to build a community and stoke interest in the release of the feature movie on cable video-on-demand and then digital platforms including Amazon and Hulu. Participation was very moderate with less than a hundred participants. Some groups went on ghost hunts and posted evidence validating the possibilities for a participatory adjunct to the narrative, but without promotion it did not cohere as a community.

## 5.9 Summary Conclusions

In summary, the four gestalts proved to be effective design considerations across the storyscape. The design documentation attached in the story bible notes how each was used, and the chart at the beginning of this chapter notes where different gestalts were applicable. Myth and oppositions worked best since stories and games have a historical

structure that incorporates conflicts. The production groups were able to leverage oppositions such as skeptic and believer without the need to understand the design methods proposed. Characters were also effective as an organizing theme for each team. Genre provided a framework for each medium that was explicit for games and stories because the horror, haunted house, and ghost-hunter genres were established. Canon was asserted by the authorial authority and of less interest to each production group. Reuse of assets across media connected the works canonically and artistically.

The goal of this research through design was not to qualitatively ask the audience whether the four gestalts created a whole storyscape in their imagination. The value of this research is reflected in the description of the gestalts and the affordances of the storyscape medium discussed in previous chapters. Teams were able to develop their narrative in each unique medium according to the four gestalt terms. There was a familiarity with how mythic oppositions or character could work in each medium and connect to other works. This and the principles and affordances noted previously allowed a consistent vocabulary in each medium so the discrete elements could be considered as an authorial whole.

Overall this approach yielded a unified language for the storyscape that resulted in clearer ideation of the storyscape as a whole and a narrative medium. The gestalts outlined a coherent visual language and canonicity that provided, with genre, scaffolding for representing the story for the creative teams in distinct media. Despite discussions of the principles and affordances of transmedia storytelling and the storyscape, these were rarely topics of the production process. Teams focused on the logistical issues of building each work and the four gestalts mapped to design principles for stories, games, and media

that were already in use. There was no thought given by the teams to whether the website was drillable or constituted a migratory cues despite discussions. The storyworld or world-building aspect was not considered and led to the conclusion that these were not influential or decisive design principles for a storyscape.

### **5.10 Practical Conclusions**

The following represents practical conclusions from the *Ghost Club* storyscape research. This is focused mostly on the usefulness of the mythology as a design approach (and indeed of all the four gestalts as applied to different media) as well as the logistical issues that impeded research objectives into affordances, design methods, and media.

Practically, myth-making was useful in multiple design situations. The binary opposition of Skeptic vs. Believer and Ghost vs. Ghost Hunter provided a central conflict to shape movies and games around. The movie used these oppositions throughout, and characters embodied either skeptics or believers. The opposition was also meant to echo the cultural mythology of ghosts to provide resonance and engagement for the audience. That was not something that was explicitly measured, but the design process, illustrated in the appendix, made use of these oppositions in nearly every medium. The AR games were about being skeptical of or believing the evidence that was captured, a flash game involved Ghosts vs. Club, and the rest of the media reflected this mythology and opposition functionally and thematically. The two key figures in the mythology were Harry Houdini, the skeptic, and Sir Author Conan Doyle, the believer, and they were featured everywhere possible. Understanding the nature of folk stories and mythological constructions, even as dramatic beats as Janet Murray terms them, helps construct the

larger mythological universe around a singular story to be told. This opposition extends into the mythology documentation and the story arcs, character arcs, canon, and genre.

Building the storyscape mythology documentation, by creating oppositions and character arcs, defining genre rules and referents, and establishing a proto-canon or backstory, which eventually became canon as media were published—all this yielded a coherent vocabulary and provided context for each subsequent medium. This mythology document (see Appendix B) is our story bible. Each subsequent stand-alone medium was added to the bible as a series of design documents that charted the evolution of the project from these mythological concerns through design and production. Oppositions—engineered through genre rules, such as a prohibition against demons and the understanding that all ghosts were human—contextualized and provided reference points to the story. Participants could construct a whole story from whatever parts they engaged in. This strategy extended into the realm of visual design, derived from the articulation of these themes, stories, and elements in order to provide coherence for the design process. Overall the vocabulary was efficacious across media. The horror genre was prevalent in all media we used and is an example of how the mythology could provide a structure for the development of the disparate parts of the storyscape.

In Theatrics there was a clear storyscape model that had been defined. As we engaged with participants, who became ghost hunter characters and uploaded their own evidence while consuming the games and stories we had created, the storyscape could be seen as a coherent whole with a well-defined mythology and canon from an authorial point of view.

Logistical issues diminished the ability to test the storyscape qualitatively because of participation and platform features. Audience activation was a challenge from our participatory website to our experience with the Theatrics.com participant platform. This was to be expected because even heavily promoted industry content often fails to attract an audience; nonetheless, lack of adequate participation prevented exploring affordances such as collective intelligence to solve riddles or motivating participants to engage all of our content. Further, the construction of movies, webisodes, and games is resource heavy, both creatively and logistically. The project was fortunate to have hundreds of professional and student writers, actors, coders, filmmakers, and transmedia storytellers, to iterate and create the large body of content. Nonetheless, as a small research project, it was impossible to keep producing content, and the augmented reality games were a shadow of what was intended as a collaborative storytelling experience united with the other content.

A storyscape is collaborative and participatory to a degree that is multiplied by the diversity of media. For each medium there are groups of authors, designers, and coders who organize their work around the core mythology of a new story or narrative game. Some authors worked nearly independently such as Brent Ogburn, who wrote and directed *The Ghost Club Girls* web series, while Jason Nunes and myself created much of the content and acted as intellectual property arbiters. In every case, the central authority edited the content against the mythology. Nonetheless, the stand-alone nature of each medium, its genre, and its pleasures made this a disbursed production process. The mythology became a core document for all creative participants to refer to as a template and inspiration.

This participation also extended to the audience. While we failed to attract a large number of active participants in our alternate reality game on Theatrics.com, the most active users imagined new stories and directions for the storyscape as a whole. Freelance writers wrote stories and histories of characters and events that took on added to the mythology. Robert Masterson wrote a history of Parnell, the tech character from the movie, as a Vietnam vet with issues and Henry Jenkins IV wrote an episode that pre-figured the group's early experiences. Thus collaboration and participation were raised to a much higher level than in any single medium, represented no previous design models, and in the process contrasted, but did not diminish, the meaning and themes the storyscape model posed as a unified medium.

## **CHAPTER 6**

### **STORYSCAPE RESEARCH PAST AND FUTURE**

#### **6.1 Introduction**

The decision to carve out a subset of transmedia storytelling as a storyscape medium allowed me to filter out much of the literature and to explore the four gestalts more narrowly. The four gestalts—mythology, character, canon, and genre—emerged through practice, scholarly research, my revised definitions of transmedia storytelling, and as a design vocabulary derived from research applied to production. In the course of my research, linear connectors became gestalts, mythology was refined into its components, and previous transmedia design principles proved secondary. Finally, the field of transmedia storytelling, both among academics and in the larger media culture, has continued to diversify, so this journey returned to a different world than it started. Nonetheless, what I call the storyscape medium itself is large and flowering with examples, and there is hope that my conclusions may find application in the broader field of transmedia storytelling and other forms of digital media narrative as they arise.

#### **6.2 Summary of the Study**

The purpose of this study was to explore transmedia storytelling as a new medium of expression. For practical and scholarly reasons this was focused on the storyscape, the franchise or complex television model that has been elaborated throughout this work. Below, I will review the problem and research questions. Then I will move to summarize my major findings.



### 6.2.1 Overview of the Problem

The current mythological transmedia franchises of *Star Wars* and the *Marvel Universe* loom large in our cultural discourse. How we design and discuss these works of art and story, implemented across multiple media, is central to the evolution of the economy of the media world and digital culture. In digital media, a methodology rooted in research through design and the relation between theory and practice drives this study toward a unifying analysis of story in the storyscape medium. The larger question of designing for transmedia storytelling is addressed through research in a medium that has been codified in academic and practical discourse. This medium that I call a storyscape is defined as: the grouping of story related works and communities across media. The storyscape must have an authorial voice (individual or communal) to determine the meaning-making systems of mythopoeia, character, canon, and genre. This grouping must contain original content—in different media not solely remediated or repurposed—that forms experiences or stories that become imagined as a whole text. A component of a storyscape may be remediated from one medium to another, as a novel to a movie, but most storyscapes are constituted of story parts that are additive or synergistic (Jenkins 2007b). The central aspect of storyscapes is to frame the relationship between the parts and the whole as gestalts. A storyscape is the sum total of all the media manifestations of a central mythology and also includes the community, media artifacts, and cultural zeitgeist that surrounds a storyscape.

This allows a more precise discussion of what it means to design for a medium of transmedia storytelling. As I noted previously, the storyscape medium encompasses alternate reality games and augmented reality as stand-alone works comprising a whole,

but suggests the study of those transmedia storytelling forms as a separate topic or medium. Further my study does not address the aesthetics or process of transmedia storytelling in all its current commercial forms. My area of investigation was the design of a storyscape, answering the research questions that were raised at the beginning of this project, and the applicability of the research literature to the study and practice of the storyscape medium.

Let's return to the research questions articulated in the introduction in order to show how they have been addressed in the preceding chapters.

**R1 How do you design a transmedia story that is comprised of different stand-alone elements, across media, and extending into the real world, but is still a coherent single work, what I have named a storyscape? What are the design principles that sum these parts into a greater whole?**

Over the course of this research, the definition of the storyscape and the models it represents were refined and clarified. This allowed the discovery of clearer links to how the story was told across media and the way those connectors worked. As the research unfolded, this understanding led to the realization that the elements identified act not simply as logical connectors, but as gestalts that are constructed by the participants in the story across their experiences. This realization was codified into the story-centric approach. This is in opposition to the storyworld models of designing a unified project. Finally, as this research was consolidated, it yielded dominant conceptual strategies, including myth-making, that further clarified the ecosystem of the storyscape and provided a design vocabulary.

**R2 What are the significant connectors, affordances, or gestalts between two or more elements of a storyscape that can animate and contribute to useful design and storytelling approaches that span different media practices and affordances?**

The mythology, character, canon, and genre gestalts were drawn from classic storytelling models, narratology, transmedia scholarship, and observations of transmedia practice and examples. These gestalts validated themselves across the spectrum of the literature and research through design. They form the core vocabulary for the creation of the storyscape medium and for a conception of that medium that is both practical and academic. Whether scholar, fan, or showrunner, for the storyscape medium, ideas such as mythology, character, and canon are central topics that are not central in academic analysis and ill defined in practice. The Marvel Universe of movies, comics, games, and more has provided an ongoing storyscape laboratory of vast cultural proportions, as the backstories, iterations, and intellectual property wars force topics such as mythology and canon to the surface as aesthetic and economic concerns. Television reboots such as the new *X-Files* series being released on Fox Networks foreground mythology as a topic of general cultural and academic interest. Finally, the *Star Wars* universe, with so much vested in its consistency and reach as it expands exponentially as part of Disney, engages these gestalts with a singular determination, as a matter not only of commercial exploitation, but also creative expression and artistic practice. This is doubly important as the central creator and determinant of the story, George Lucas, passes the reins to other artists, a corporation, and the fans and leaves the role of myth-maker and visionary.

While the first question was how we sum the whole, this second question focuses on the way these gestalts in practice can contribute granular connections and how we

achieve the parts. By defining these elements and analyzing how they work in the design process, I have identified useful story design paths and methodologies for further research and practice. I have tested the robustness of the gestalts. I have also explored how these connectors engage an audience across different media affordances and how they create the story meaning-making platform. Most prominently addressed under this research question is the definition and analysis of mythology as it functions in a storyscape. This will also illuminate how story works within a storyscape discourse.

**R3 What is the design language of transmedia storytelling including a vocabulary and syntax required to describe and create the parts and relationships of a storyscape across media and the discourse about this medium?**

Starting with the four gestalts and the naming of the medium as a storyscape, the core vocabulary of the gestalts, principles, and affordances were employed and applied across the research and projects. While there is a profusion of terms and production processes, the research helped elicit a vocabulary that could be used across the design process of a storyscape. Many of these terms derived from approaches, methods, and affordances that were organized to grapple with the multiplatform implementations and iterations of a storyscape.

**6.2.2 The Evolution of My Model and Vocabulary**

In reviewing the literature there were a number of findings that helped to determine the limits of my research proposal and the evolution of my model and vocabulary. The breadth of transmedia writing and the number of transmedia models in

academia, not to mention the confusion and disagreement about the scope of the field, led to an iterative refinement of the storyscape model. Folding in the practice of transmedia production and its documentation pointed toward the need to define parameters.

Narrowing examples of this medium to the storyscape, derived from the West Coast transmedia model, gave impetus to the four gestalts, which resonated under scrutiny and became clear-cut in their definitions. Business models and other critical theories, such as Mark Wolf's (2013) imaginary worlds or Jonathan Gray's (2010) discussion of paratexts, illuminated the path and refocused the research on a story-centric model that could creatively unite theory and practice. The practice of producing a storyscape was marked by methods, affordances, and aesthetics that define the storyscape medium. Narratology, the study of mythology, and semiotics contributed to understanding how the core story could be constructed in a new medium that contains and extends the aesthetics of Aristotle, but also transforms into a new aesthetic that is represented by the open work, with its scrambled beginnings, middles, and ends (plural deliberately). This new aesthetic finds catharsis and immersion in the sum of a complex ecosystem of story. This is a story that is authored and also written by its readers or viewers.

The storyscape provides a useful model to extrapolate from literature and practice because the multiplicity of transmedia definitions and forms hindered the development of a coherent vocabulary. *The Matrix/Star Wars* franchise medium was framed and described in theory by Jenkins and Long, and in practice by Jeff Gomez and the Producers Guild, but this new medium was not named. Naming it and pulling out a definition and set of associated qualities allowed my research to focus on definable medium. The realization that the field of transmedia was too broad for this study and that

much of the literature tried to make sense of too many divergent examples to be useful as a design or vocabulary method made a good starting point. This is not to say that transmedia as a field can be defined or has stopped evolving, but rather that the storyscape and the ARG can be analyzed as a medium with examples and a specialized description.

The need to unite theory and practice also emerged from the literature analysis. While the need for unification began as a fundamental assumption, it soon became apparent that different methodologies and approaches were active in the field. Some approaches were ethnographic, while others focused on a broad aesthetics. Some narrowed the field down to a single reference point (as Long did with canon or Evans with character). This method of integrating theory and practice also pointed to the centrality of story in practice, and how the aesthetics of storytelling have changed in the storyscape. Though some scholars posit a new storytelling practice that flows from a storyworlds concept, the literature indicated a practice more closely situated to a historical storytelling model that had a central conflict, or plot, and characters that commanded an audience's attention over time. The open work, extensive myth-making, multiple narrative points of view, and the affordances of diverse and digital media have changed the traditional aesthetics profoundly, but not replaced it with a new storyworld aesthetics.

Mythopoeia, character, canon, and genre flowed directly out of the literature reviews and investigations. As a whole this vocabulary and the use of these design gestalts to knit together a storyscape as a whole came into focus. Many transmedia scholars touched on them in small or large ways, some, as noted, focused exclusively on

certain aspects, such as the need for a coherent canon. This need was echoed across many writings. Mythopoeia, as a determinant of overall story and providing a meaningful linking, turned up often in practice. It was commonly invoked in academic writings, but was also often lost in perspectives that weren't focused on how stories get told or whether the stories' resonance was related to its meaning. Scholars were often interested in taxonomies or how to present these artifacts in a context while creators were re-inventing myths, and figuring out how the pleasures of stories translated into the storyscape and its individual instantiations.

This led back to a story-centric approach that connected fairy tales and myths to a newly constructed form of mythology for these storyscapes. This approach, uniting theory and practice, through academic research and cross-referencing production culture in the field, allowed for the emergence of a unified field. Unique affordances could be seen in the context to of the storyscape as a whole, derived from the four gestalts. Other transmedia models could be ignored as irrelevant to this more focused model and story-centric approach. Business models and their logistical and creative interests could be held in abeyance, as the focus lay on the fundamentals of storytelling united with an understanding of what stories do in this new medium and how they are told.

The goal of this research was not to produce a qualitative study in which random participants are quoted to support the ideas contained within, but rather to investigate the literature, examples, and practice to extract methods to design a story-centered approach. This approach also led to a conceptual framework that evolved from the concept of logical connectors, often plot points, proposed by many scholars to a method of four gestalts that allows the whole to be comprehended in the negotiation of meaning and

immersion with the viewer. This meaning and immersion can also exist in paratexts expressed through performative extensions of the story to the cognitive model that participants bring to movies or games.

#### **6.4 Identifying a Medium of Media, the Storyscape**

Identifying the storyscape as a unique medium allowed me to refine the current vocabulary on transmedia and identify a design practice appropriate to the qualities of the medium. In this way, myth-making and other central story premises emerged as defining elements that play a more essential role in storyscapes than in other transmedia forms, such as alternate reality games. Examining the storyscape medium in isolation provides greater theoretical clarity.

This solution allowed me to draw insights from Long, Askwith, Jenkins, and Evans insofar as they addressed transmedia as a single medium. Jenkins seemed to identify this medium in his *Matrix* analysis; Long spoke directly to the franchise model, but it lacked a name. Storyscape may not take hold as the name of this medium, but it is an advantage to offer the name, so as to lend specificity to the discourse around transmedia. In practice, this may contribute to further discussions within the Producers Guild on the question of defining a field of transmedia producer. The notion of the storyscape provides a context for the work of other transmedia scholars, such as Christy Dena or Jane McGonigal, who define another medium or a medium of multiplicity that has no boundaries or consistent aesthetics and is acknowledged to be in a field of flux. This is a filter for the new proliferation of transmedia work in education, documentary, and art installations, all of which may integrate story across media. Many interactive narratives also share transmedia traits but are not storyscapes.



This also has a practical application for the community that works on these storyscapes. The concept of the storyscape provides a model for defining the core properties to be extended or addressed across media. For the IP owners it isolates core issues they must engage, like canon, in a more pronounced way. It begins to define an aesthetic of this medium in its multimodality, with relevant affordances or qualities. My vocabulary (with its gestalts, affordances, and methods) should constitute a coherent toolset for thinking about designing a storyscape. My primary contribution to design is the four gestalts.

### **6.5 Four Gestalts as Design and Analytical Practice**

The four gestalts represent the series of findings that evolved from this research. The first finding relates to how an audience builds a whole story in its engagement with stories spread across media. My work revealed how mythopoeia dominates the storyscape and embodies central ideas and narrative arcs that are meant to maximize the power of the storyscape through immersion, resonance to personal and cultural concerns, and forms of catharsis. Originally, the question was what connected these parts together as a whole. This was revealed as a process of negotiation with the participant that allowed them to create that whole from any subset using the structure and context of the four gestalts. Character, canon, and genre are also foregrounded and integrated into an ecosystem for design and critical analysis. Further discussion following this section notes how the gestalts worked in practice in *The Ghost Club* storyscape and how that success reflected back on the premise and research.

The four gestalts map better to a design approach than world-building in three ways:

1. They unify theory and practice because they form an overlap of the concerns and

vocabulary of both groups. This model is more consistent with practice by relocating aspects of world-building within a practice of creating a transmedia mythology.

2. A gestalt is shown to more accurately describe the relationships across media as opposed to the rigidity of looking at plot connectors or physical attributes of transmedial systems.
3. The four gestalts show continuity between old media and digital media inasmuch as they evolved from other story practices such as backstory or character continuity as an organizing principle. The four gestalts represent a coherent extension of storytelling to this new medium. They extend known narrative principles. There is no need to posit a new world-building narrative aesthetic or narrative model for this medium.

### **6.5.1 Myth-Making and Mythology**

Although the conflicting uses of the term “mythology” became a knot to untangle, the concept ultimately proved to be the most useful gestalt. Mythology has been invoked in numerous definitions across the spectrum of transmedia storytelling. These definitions are to be found in literature as diverse as the scholarly work of Ryan to *Variety Magazine*. It was the use of mythopoeia in the storyscape examples (*Lost*, *Star Wars*, etc.) that dictated a new definition to be applied to this new medium. Likewise, the examples showed how important it was to understand how story construction worked across media. In the design of such storyscapes, mythic oppositions are exploited, characters arcs are planned, and the canon is affirmed. By considering the rhetoric of transmedia practitioners as well as key examples, I have established that myth-making

(creating a mythological structure for the storyscape) is a conscious practice, as is the evolving of the mythology across the various media elements of the storyscape. This stable and robust finding stands in opposition to transmedia theories that hinge on the concepts of world-building and storyworlds.

### **6.5.2 Character, Canon, and Genre**

Together with mythopoeia, canon, character, and genre constitute an ecosystem for the storyscape—an ecosystem that is prescribed at the beginning, but evolves through the narrative practices of the media elements. The mythology, as was laid out, often contains these gestalts, so there is an interaction within the ecosystem of these gestalts. Long foregrounded canon for coherence, Evans extolled the usefulness of character as a thread through transmedia, and many other writers and authors have analyzed transmedia according to these gestalts. This design approach reveals how these terms integrate, evolve, and reflect on each other as a design process and a gestalt of the whole storyscape as the participant engages with it.

### **6.6 Next Steps: Additional Storyscape Research**

Synchronization, repetition, and landmarks are affordances of a storyscape that I wish to investigate further and integrate in a theory for a design method. In a storyscape, they represent the ways in which an audience participates and organizes its view of the full story. Synchronization of the story and elements across media, and also interpretation with other participants is expressed across the social media platforms. Repetition across media forms allows redundancy in information flow and a more complete gestalt of the whole. Repetition also allows different viewpoints to express a multifaceted storytelling

experience. Finally, landmarks—story points, ideas, or characters—act to map the relationships and overlaps of the gestalts in the storyscape media. Synchronization and repetition allow the participants to compare and use the landmarks to situate their experiences as well as their comprehension. These elements bear closer scrutiny in the storyscape and other transmedia storytelling platforms.

There is a need for further design process explorations based on the research through design of *The Ghost Club* storyscape. In order to better understand collaborative authorship, design goals, etc., these documents can be mined for how these processes evolved or found the gestalts translatable across media.

### **6.7 Concluding Remarks**

In the final analysis, the examples of the storyscape are clearly related to imaginary worlds, worlds of fairy tale and myth. However, from my point of view I see myth, religion, and science as narrative systems to explain our world, worldview, morals, or ideology, or to provide examples of behavior and social communities to join. In this regard, I hope that the storyscape's four gestalts will find an application beyond the narrow scope of mothership transmedia models that I have defined as a storyscape. The four gestalts may create a design template for other forms of transmedia storytelling such as an ARG or building a story using an Internet of Things. Understanding the place of contemporary myths as a way to understand the world and our place in it can prove useful as a method for storytellers and a frame for academics researching the new story forms of digital media.

The myth-making focus of this story method recognizes that stories define a truth within a larger contextual system of meaning. This meaning infuses the world we live in

as a metanarrative that describes the ideological themes that are relevant to our culture as stories. The storyscape, as a representative and subset of these metanarratives, encodes a system of relative truth. Truth, for these grand metanarratives, was the domain of religion and myth and is now communicated and encoded in the stories, games, experiences, and rituals that are both entertainment and provide a focus for communities to create meaning and identities.

Comparative storyscapes in the pre-digital affordance past include Christianity as a transmedia revelation and, for Western culture, the Greco-Roman myths that formed a pantheistic religion in which social and moral codes and principles for understanding the natural world were present or encoded. We use stories to create a gestalt that explains our place in a world whose logic seems to be either random or too complex to comprehend through other ways of knowing.

In our secular, scientific world of fractured subcultures and contextualized truths, authors and communities will create stories, derived historically from previous relevant stories, and through individual and group expressions, create mythic structures, binary oppositions, and conceptual frameworks to answer our cultural anxieties and the innate conflict of unresolvable questions. In storyscapes, the participation of the community is capable of building their own cultural ecosystem of meaning creation. They can do this through influencing a television show by killing off characters such as in *Lost*, in active participation in games with other users of the same storyscape, or by creating original work that explains and expands on the mythic themes.

Storytellers tell stories to make sense of our world and often see themselves as contemporary mythmakers. In that sense, they are creating a kind of truth that explains

the world and anxieties we encounter. Storytellers try to reinterpret and find fundamental truths, not necessarily as a conscious act, but as representatives of the cultural communities of these works.

In conclusion, my main points are thus:

1. Myth-making, with character, canon, and genre, provides a superior model for the storyscape medium than world-building or storyworld methods or models. Further this method should be seen as a critique of the narrative storyworld model because it does not support a convergence of theory and practice.
2. Transmedia, transmedia storytelling, and storyworlds have become confusing terms that are used to describe contradictory methods and theories. Academics are mixing terminology and media so as to make investigation impossible. Defining the storyscape medium, and its qualities and affordances, can start us on a path to categorizing other transmedia forms as they become codified and significant examples are created.
3. The storyscape method and theory provides a model and vocabulary that can be used by both storytellers and academics despite the fact that they have different ways of knowing the world. In this theory these two ways of knowing can be seen as two sides of the same coin: myth-making on one side and mythic analysis on the other.

## APPENDIX A

### GLOSSARY

**Affordances:** Defined by Donald Norman (1988) in *The Design of Everyday Things* as “the perceived and actual properties of the thing, primarily those fundamental properties that determine just how the thing could possibly be used.” (9)

**Alternate universe:** In order to accommodate canonical breaks in a storyscape the medium as a whole subscribes to a multiverse model in which similar but distinctly different sets of stories can be told. Alternate universes may involve canonical or character changes. There is sometimes interaction between these alternate universes.

**ARG:** An alternate reality game, a form of transmedia storytelling that has been used as part of larger storyscapes. It usually involves both online and off-line experiences in a linear time-based story.

**Authorial Authority:** An individual, group, or corporation that exercises legal authority in defining what is authorized and canonical in a storyscape or franchise. User groups can leverage consensual authority that may be influential.

**Binary oppositions:** Extended from mythic oppositions—early stories that reflected the origin of cooked meat, the opposition of raw and cooked in culture. In contemporary narratives, this opposition is thematic and may contrast oppositions such as religion and science. For Aristotle, this was the dramatic conflict that drove a play to its catharsis.

These oppositions create a structure to use stories to resolve complex oppositions such as love against duty in such a way that creates a cultural satisfaction.

**Canon:** The accepted definition of a fictional event, explanation, or mechanic. It can be accepted by varying authorities and is often disputed or changes. Intellectual Property (IP) holders determine canon from a legal standpoint but may choose to enforce their view to varying degrees. Fans also unite and determine a secondary definition of canon through collaborative sites. This is often in the gaps where the IP is undefined or there is factual conflict between different media in a storyscape.

**Collective intelligence:** Coined by Pierre Levy to refer to new social structures that enable the production and circulation of knowledge within a networked society.

**East Coast Transmedia:** The open approach to transmedia storytelling that may be small or rely on only a few media elements. It does not recognize an accepted definition of transmedia storytelling but considers the medium a series of narrative or commercial experiments around the broader concept of transmedia.

**Fanon:** A term used to describe commonly accepted interpretations about storyscapes that are not acknowledged canon or changed canon. This can be related to fan fiction, possible speculation about story elements, or specific subgroups that create their own mythology documentation.



**Flash-Forward:** Advancing the narrative story forward in time. The opposite of a narrative flashback in time.

**Gestalt:** An organized whole that is perceived as more than the sum of its parts. Gestalt therapy was derived from psychology but can be applied to artistic comprehension as an aesthetic principle. Gestalt is a basis of visual design understanding and is here applied to narrative and semiotic constructions. Narrative systems function as wholes and their meaning cannot be fully comprehended in terms of their components or discrete media.

**Landmarks:** Mythic events, significant conflicts, character conflicts and motivations, and cathartic events that can be used by the audience to compare subjective views. Agreement or disagreement provide narrative clarity and define subjective definitions between individuals and groups. It is especially useful as a design tool to carry across media signification of complex meaning configuration with the larger story structure including binary oppositions.

**Migratory Cue:** Defined By Marc Ruppel as: “the means through which various narrative paths are marked by an author and located by a user through activation patterns.” (Long 2007, 59)

**Mythology Documentation:** Analogous to the story bible but constantly updated by new canonical artifacts that flesh out the story boundaries, characters, and canon. This can be

a physical document or held within an authorial authority. As a foundation for canon, it is subject to change by decree by an IP authority.

**Mythopoeia:** Contemporary myth-making. It is secular, but whether created consciously or unconsciously, creates semiotic structures of signification that resonate for individuals or cultural groups as ideology and cultural themes.

**Negative Capability:** The mystery of unexplored possibilities and tangents in a storyscape or franchise. In imaginary worlds, this holds the promise of glimpsing original explorations based on underlying premises or themes. It also allows characters to branch out from main story lines.

**Paratext:** Anything affiliated with a storyscape inasmuch as it can be used to derive additional story elements not part of the primary story or stories. These imagined story elements may be solely reserved to the participant or shared by groups of different sizes. Significantly merchandise, clothing, and experiences can give rise to paratexts.

**Research through design:** (In this work) a narrative game design model that allows researchers iterative design efforts to investigate wicked problems that can not be addressed through normal scientific methods. Like architecture and games, storytelling media production as a research product is a wicked problem. Positive results include a transfer of knowledge between artists and scholars and across media specializations, it

reframes problems through contact with practice, and it motivates digital theory to engage in world impacts.

**Sideways (story):** The use of an alternate universe or timeline to express another story perspective unmoored to canonical or character reality in other versions of the fictional story.

**Story Bible:** Originally a document to plot out television programs. As long-form arc storytelling evolved the story bible became a more comprehensive document describing the story, character, setting, tone, and other narrative elements. In imaginary worlds, this involved fleshing out supernatural logic or magical technologies. It also involved the subcreation of a world not linked to our real world and requiring a revised cosmology.

**Storyscape:** The of story-related works and communities across media. The storyscape must have an authorial voice (individual or communal) to determine the meaning-making systems of mythopoeia, character, canon, and genre. This grouping must contain original content—in different media not solely remediated or repurposed—that forms experiences or stories that become imagined as a whole text. A component of a storyscape may be remediated from one medium to another, as a novel to a movie, but most storyscapes are constituted of story parts that are additive or synergistic. The central aspect of storyscapes is to frame the relationship between the parts to the whole as gestalts. A storyscape is the sum total of all the media manifestations of a central mythology and also includes the community, cultural zeitgeist, and media artifacts that surround a storyscape.

**Storyworld:** A term with many uses. Marie-Laure Ryan's is the most complete for the purposes of transmedia storytelling. 1. An inventory of existents, comprising (a) the kinds of species and objects that (a) the kinds of species and objects that populate the storyworld; (b) the cast of individual characters who act as protagonists

2. A folklore relating to the existents (backstories, legends, rumors)

3. A space with certain geographic features

4. A set of natural laws

5. A set of social rules and values

Dynamic component:

6. Physical events that bring changes to the existents

7. Mental events that gives significance to the physical events (i.e. the motivations of the agents and the emotional reactions of both agents and patients), affect the relations between characters, and occasionally alter the social order (Ryan 2012 p. 362-7).

Storyworlds also describe the mythology or story bible documentation. Finally, storyworlds can focus on the production design or physical characteristics of a series of connected fictional world so as to extrapolate a physical space.

**Synergy:** The financial consideration of the exploitation of stories across media. There are profit and marketing incentives to transmedia expressions. IP owners are usually primarily motivated by profit concerns, and this works as a parallel development to the creative storytelling.

**TINAG:** An acronym for This Is Not A Game. The implication of reality in a game is related to verisimilitude, and a storyscape's integration into real world interactions.

**Transmedia:** The use of more than one media to communicate.

**Transmedia storytelling:** Two or more media revolving or adapted from the same story. This also applies to more robust uses of telling stories across media where the intention is to integrate multiple media. It also applies in the case of an Alternate Reality Game that employs a multiple media mechanic. Finally, it is also used to describe franchise models of integrated storytelling across media. Transmedia storytelling is not limited to fiction or any other genre.

**Triangulation:** A storyscape design affordance that allows an individual or a group to perceive the same landmark from different media perspectives and compare them. Multiple perspectives potentiate enhanced affordances across media for a complex understanding of the landmark. Other participants can compare more, or unique, perspectives to create shared meaning in the audience.

**Verisimilitude:** Used by Christy Dena to describe how transmedia aesthetics and storyscapes often overlap with the real world or are set up to present an alternate reality as true and participatory.

**West Coast Transmedia:** *The Matrix* storyscape or franchise model of transmedia storytelling. *Star Wars* and other highly capitalized models exploit and integrate the

stories, games, merchandise, experiences, and marketing with a coordinated IP. This model represents a Hollywood view and the Producers Guild definitions.

**World-building:** The engineering and aesthetic design of an imaginary world. History, ecology, geography, and supernatural laws are often articulated. Maps and backstories are often key elements.

## APPENDIX B

### THE GHOST CLUB STORYSCAPE MEDIA LINKS

***The Ghost Club: Spirits Never Die (feature film)***

<https://vimeo.com/67622190>

Password: neverdie

***The Ghost Club: Spirits Never Die (trailer)***

<https://www.youtube.com/watch?v=oyOP1W5RQ9w>

**Android Ghost Hunting App:** Free augmented reality app so you can “find” ghosts at your current location and create photo evidence. A demo of the app can be viewed at:

<https://play.google.com/store/apps/details?id=com.hauntedplanet.branded.ghostclub>

**Ghost Club website:** Home, store, Ghostpedia, web series, Join a Club

<http://www.ghostclubusa.com/home.php>

**Theatrics.com:** Video documentation

<https://vimeo.com/79516268>

**YouTube.com:** YouTube channel

<https://www.youtube.com/user/TGCTheGhostClub>

***The Ghost Club Girls:*** A web “reality” series that introduces viewers to The Ghost Club team and their investigations. Watch the first episode here:

<https://www.youtube.com/user/TGCTheGhostClub>

***Ghost Club University:*** Do your own ghost hunting:

<https://www.youtube.com/user/TGCTheGhostClub>

**Facebook**

The Ghost Club Facebook page:

<https://www.facebook.com/TheGhostClubUSA>

**Twitter**

<https://twitter.com/tgctheghostclub>

**Twitter/Jimmy:**

[https://twitter.com/GhostClub\\_Jimmy](https://twitter.com/GhostClub_Jimmy)

***The Skeptics Diary,*** Ghost Club comics

<http://skepticsdiary.tumblr.com>

**APPENDIX C**

**THE GHOST CLUB STORYSCAPE BIBLE**

**The Ghost Club  
Storyscape Bible**

9.30.14

Updated HRB

Contact: Hank Blumenthal  
hankblumenthal@gmail.com  
917.687.2445

Version 1.0

Copyrighted and Trademarked



## Table of Contents

THE GHOST CLUB HISTORY .....	273
Gaslight & Steam--The Victorian Ghost Club: .....	274
Gaslight & Steam--The Victorian Ghost Club: .....	274
Technology for this narrative includes: .....	274
The Team: .....	274
The Mission: .....	275
Electricity & Diesel--The Edwardian Ghost Club: .....	276
Technology for this narrative includes: .....	276
The Team: .....	276
The mission: .....	276
GHOST CLUB Depression era 30's40's .....	278
Reality TV & The Internet--Today's Ghost Club: .....	279
Technology for this narrative includes: .....	279
The Team: .....	279
The Mission: .....	279
Possible Continuation: .....	279
THE GHOST CLUB MOVIE Part 1 .....	282
Key Characters .....	282
Parnell Origin Story .....	291
TGC LEGENDS – Arthur and Harry .....	293
ART ASSETS 299	
LOGO .....	299
LOGLINE .....	300
Web components .....	301
The Ghost Club (fictional organization) site .....	301
GHOST CLUB HISTORY .....	306
Twitter .....	317
Flash Game .....	319
Vision statement .....	319
The Ghost Club Flash Game .....	319
Motivation/Opportunity .....	319
Problem Statement .....	319
Product Position Statement .....	319
User Demographics .....	320
Feature List .....	320
Constraints .....	320
User Stories .....	320
The Ghost Club TV Show Bible .....	321
AUGMENTED REALITY GAMES AND STORY .....	322
Product Vision Statement .....	322
Architecture .....	324
ARGON VERSION IPHONE AUGMENTE REALITY GAMESTORY .....	326
Design graphic - Slider .....	326

Augmented Reality - Button ..... 327  
TGC GAMES AND APPS ..... 332  
    Iphone Game (augmented reality app)..... 332  
Flash Games..... 337  
    Ghost Club Flash Game ..... 385

## THE GHOST CLUB HISTORY

The Ghost Club, with its roots in gaslight and steam, was founded in 1862 to investigate ghosts and psychic phenomena. To prove or disprove the existence of the beyond. To make contact.

Since it's founding, Ghost Club teams--always made up of believers and skeptics (the most famous being Sir Arthur Conan Doyle, and Harry Houdini)--have investigated every reported haunting in the United Kingdom, and the United States.

The Club has been investigating for over 150 years. They have never gathered a single scrap of proof.

In 2011, The Ghost Club was a popular reality TV show. Following in the traditions, and using the technology of the Club, dedicated paranormal professionals--skeptics and believers--investigate reports of the bizarre and unusual.

When the team decides to try their luck at an abandoned mansion in the Deep South with a long and dark history, they encounter something beyond their wildest dreams.

### **Synopsis (The Bigger Picture)**

The oldest organization in the world dedicated to psychical research, The Ghost Club was founded in Cambridge's Trinity College in 1862. Its mission, to investigate unexplained phenomena, record the results for posterity, to prove or disprove the existence of ghosts, and--if they exist--to make contact.

From its founding, the Club has been made up of an equal number of skeptics and believers. Club tradition holds that all investigations must include a lead skeptic and a lead believer, that, following the strictest scientific methods, the skeptic and believer must work together to gather and analyze the data, to jointly determine any conclusions supported by said data, and, if warranted, to attempt contact. Together.

Never lacking in funds, due to its many illustrious members, the Club has always strived to acquire the latest (often experimental) investigating equipment available. From Edison's Fluoroscope (which caused more than one case of "unexplained wasting illness"), to Daguerreotype photography, Ghost Club members have had access to, and used, some of the most innovative technologies of their day. To top this off, The Club has always funded its own research and development efforts, often combining emerging technologies to create unique devices. Club archives are full of these experimental apparatuses. Far from being museum pieces, the Club still uses some of the equipment from the 19th and early 20th century today for modern day investigations.

Though the Club has existed for nearly 150 years, and conducted investigations during all that time, it was most famous during 3 periods; 1840 - 1850, 1915 - 1925, and today. During these periods the Club became a form of popular entertainment of the day, much to the chagrin of its more staid members, with Ghost Club stories appearing in newspapers, pulp fiction, and, lately, as a popular reality TV show.

During each of these famous periods, the Ghost Club was led by the charismatic, and famous. From Charles Dickens to Harry Houdini. Self-serving, these Club luminaries used their association with the Club to promote themselves, and their ideas.

These periods are known as:

***Gaslight & Steam--The Victorian Ghost Club:***

Charles Dickens - Skeptic  
Washington Irving - Believer

Also known as the Silver Age of the Ghost Club, the early days of the club coincide with the Romantic Movement. The leaders of the club--Charles Dickens, the skeptic, and Washington Irving, the believer--performed many investigations, joined on their most infamous by Edgar Allen Poe, who claimed that some of his stories were based on what they discovered, but could never prove.

Technology of the time included:  
Daguerreotype Photography  
The Colt Revolver  
The Babbage calculator

***Gaslight & Steam--The Victorian Ghost Club:***

Robert Masterson

**Technology for this narrative includes:**

Magnifying glass & Microscope (description: Jone's Most Improved Microscope by Peter Dollond (1730–1820) London ca. 1800–1820, lacquered brass, steel, signed on folding tripod "Dollond, London.," one eyepiece, six objective lenses on revolver, Lieberkuehn-mirror, tweezers and bullseye-condensor, four object slides and other accessories. Original mahogany case, Size of case c. 8 x 24 x 20,4 cm, height of microscope table c. 15,5 cm. (WU).

Daguerreotype Photography

**The Team:**

Charles Dickens - Skeptic

Washington Irving - Believer

Poe - Gadfly

Wavering between being an obnoxious semi-drunk and a witty, insightful Nick Charles kind of semi-drunk, Poe needles Irving by calling him "Natty," the James Fennimore Cooper hero of *The Leatherstocking Tales*, as if he doesn't know the difference between the New England writers.

Dickens, while a skeptic, has a savvy eye on the marketing opportunities of each investigation as a way to boost sales. Dickens is poverty phobic and milks each mission for its sales potential.

Irving is head-over-heels in love with the gothic possibilities in all situations, New England as heaven on earth, and himself. His need to believe in the supernatural is rooted in his own egomaniacal belief that he is gifted to see in ways that others are not.

### **The Mission:**

Hearing about the strange goings-on at a Boston home, Irving and Dickens descend to investigate. Five years previously, the young mistress of the household, Abigail Higgins, nearing the birth of her first child, apparently tumbled down the wide curving stairway to her death and, as dying, gave birth to a son who died before either was discovered. Rumors of murder dogged her husband, Rigwell Higgens, and he eventually shuttered the home and left Boston under a cloud of unprovable suspicion. After five years, the house was offered for sale through an agent instructed to keep its past quiet and the new inhabitants discovered a psychic disturbance at the foot of the stairway. It appears as if the place where Abigail and her son died is the site of mysterious and unexplainable activities...sudden cold, piercing and unexplained pains, and an overwhelming sense of confusion and fear. Use of the magnifying glass, the microscope (microscopic ice crystals, for instance, on a summer day), and daguerreotype photography (cloudy, indefinite forms on the otherwise empty landing) yield tantalizing yet inconclusive results.

Despite repeated and varied efforts to contact and assuage the ghost of Abigail Higgins, the investigation, conducted as thoroughly as possible, reveals no answers and each investigator leaves the mission feeling frustrated and angry with the others.

### ***Electricity & Diesel--The Edwardian Ghost Club:***

Harry Houdini - Skeptic

Arthur Conan Doyle - Believer

The Golden Age of the Ghost Club revolved around the tumultuous friendship between Harry Houdini, and Arthur Conan Doyle. The pair had many fallings out over Arthur's rabid dedication to the Spiritualist movement, and Harry's unwillingness to reveal how he was able to perform his feats of "magic". Though they performed fewer investigations than Dickens and Irving, their popularity, showmanship, and feuding brought the Club into the public imagination as never before, or since. An adoring public devoured newspaper reports, and Doyle's shorts stories based on investigations. The final split between Harry and Arthur, directly following an investigation, marked the end of the Club's popularity. The two men would never talk again, nor would they reveal what they discovered that fatal night.

#### **Technology for this narrative includes:**

Illuminated magnifying glass

Illuminated microscope

Photography

#### **The Team:**

Harry Houdini - Skeptic

Arthur Conan Doyle - Believer

Houdini and Doyle interact and investigate together though reluctantly. Each feels the other is hopelessly biased and subjective due to their respective occupations. Doyle accuses Houdini of cynicism based on his mastery of illusion and his own thwarted attempts to find real evidence of the supernatural and the means to contact his dead mother. Houdini finds Doyle hopelessly romantic, egotistical, and inflated with the certainty that, because he created Sherlock Holmes, the literary detective's skills are his own. The whole thing with the fairies becomes a running joke with which Houdini belittles and taunts Doyle. Doyle fires back with his contempt for a vaudevillian faker.

#### **The mission:**

Again called to the Rigwell home by the current residents, The Ghost Club picks up where the last team left off. The bottom of the stairway is still the site of sudden drops in temperature, nausea, fear, and confusion.

Using the technology available, they nonetheless attempt to contact the ghost of Abigail Higgens as the source of the very real and now even more measurable manifestations (ice crystals and more distinct yet still enigmatic forms on film) in the old Rigwell home.

Again, their results are inconclusive at best. Each, again, feels he is right in seeing the investigation as supporting their preconceived expectations.

Technology of the time included:

Motorized Movie Cameras

Ecstasy

Short Wave Radio & the Superheterodyne Radio Circuit

The Lie Detector

The Mechanical Television

1867

Christopher Scholes invents the first practical and modern typewriter.

1876

Alexander Graham Bell patents the telephone.

1877

Thomas Edison invents the cylinder phonograph or tin foil phonograph.

Edward Muybridge invents the first moving pictures.

1878

Sir Joseph Wilson Swan was the first person to invent a practical and longer-lasting electric light bulb.

1880

The British Perforated Paper Company invents a form of toilet paper.

Englishmen, John Milne invents the modern seismograph.

1881

Alexander Graham Bell invents the first crude metal detector.

David Houston patents the roll film for cameras.

Edward Leveaux patents the automatic player piano.

1884

George Eastman patents paper-strip photographic film.

Frenchmen, H. de Chardonnet invents rayon.

Lewis Edson Waterman invents the first practical fountain pen.

James Ritty invents the first working, mechanical cash register.

Charles Parson patents the steam turbine.

1885

Harim Maxim invents the machine gun.

Karl Benz invents the first practical automobile to be powered by an internal-combustion engine.

Gottlieb Daimler invents the first gas-engine motorcycle.

1886

Josephine Cochrane invents the dishwasher.

Gottlieb Daimler builds the world's first four-wheeled motor vehicle.

John Pemberton invents Coca Cola.

1887

German, Heinrich Hertz invents radar.

Rowell Hodge patents barbed wire.

Emile Berliner invents the gramophone.

F.E. Muller and Adolph Fick invent the first wearable contact lenses.

1888

Marvin Stone patents the spiral winding process to manufacture the first paper drinking straws.

John Boyd Dunlop patents a commercially successful pneumatic tire.

Nikola Tesla invents the AC motor and transformer.

1889

Joshua Pusey invents the matchbook.

Sir James Dewar and Sir Frederick Abel co-invent Cordite - a type of smokeless gunpowder.

1891

Jesse W. Reno invents the escalator.

1892

Rudolf Diesel invents the diesel-fueled internal combustion engine.

Sir James Dewar invents the Dewar flask or vacuum flask.

1893

American, W.L. Judson invents the zipper.

1895

Lumiere Brothers invent a portable motion-picture camera, film processing unit and projector called the Cinematographe. Lumiere Brothers using their Cinematographe are the first to present a projected motion picture to an audience of more than one person.

1896

American, H. O'Sullivan invents the rubber heel.

1898

Edwin Prescott patents the roller coaster.

Rudolf Diesel receives patent #608,845 for an "internal combustion engine" the Diesel engine.

1899

I.R. Johnson patents the bicycle frame.

John Thurman patents the motor-driven vacuum cleaner.

## **GHOST CLUB Depression era 30's40's**

### ***GHOST CLUB 50's/ 60's the hippie vs. conformist split***

#### **Reality TV & The Internet--Today's Ghost Club:**

Jimmy, Parnell, Noreen - Skeptics

Tab, Austin, Caitlin - Believers

After a long decline following the falling out of Conan Doyle, and Houdini, The Ghost Club emerged back into pop culture when the local American chapter was turned into a reality television program. While not technically associated with the official Ghost Club any longer (the American Chapter was official kicked out once the show hit the air), the Ghost Club television show follows the tenants of the Club, makes many references to Club history during each program, and utilizes Club-like equipment. The show's popularity has waxed and waned, depending on the season, and their investigations, but has garnered a dedicated following, in part due to the sparky, almost combative



relationships between the Ghost Club's investigators. The show was cancelled mid season, during the 5th year of the program, following a particularly challenging investigation, which resulted in the disappearance of several of the show's cast.

There are many stories from each era of The Ghost Club. All inhabit the fertile ground between belief and skepticism. Between proof and the unexplainable. Between friendship and betrayal. The Club's illustrious members uncover clues, discover secrets, record evidence, but never agree on what they've found. The proof and contact they strive for is always just out of reach. Their investigations dissolve into gothic ghost stories. Always leaving the audience wondering what actually happened...

### ***Reality TV & The Internet--Today's Ghost Club:***

#### **Technology for this narrative includes:**

Full spectrum microanalysis viewer  
Multi-spectrum digital photography

#### **The Team:**

Jimmy, Parnell, Noreen - Skeptics  
Tab, Austin, Caitlin - Believers

#### **The Mission:**

Once again called to investigate the Rigwell home's stairway, their advanced technology confirms earlier findings, but it is The Ghost Club's empath who finally cracks the mystery with the realization that the ghost is not that of Abigail Rigwell. "This spirit is not angry at dying or being murdered. It is afraid...it's afraid of having been born so alone and so cold...it's not the ghost of Abigail, it's the ghost of *her son*...there are no words for these feelings, these sensations for the child himself has no language with which to express his fear and isolation" left cold, frightened, and confused to die on the cold marble hall of the entryway. Though heartbreaking, the team must leave the infant Rigwell to suffer alone, cold, and hungry for eternity...unless they can rouse the spirit of his mother, Abigail, to come forth from beyond to claim her long-lost infant.

#### **Possible Continuation:**

The main problem for a reunion is that Abigail's shade is unaware of the passage of time for, in the afterlife, "a second is as a year and a year is a second." How can the team contact Abigail Rigwell to let her know her son needs her? Will contact with Abigail resolve the question of her possible murder at the hands of her husband?

Stories about the Club fall into 2 categories -- Ghost Club Origins with Dickens and Irving, and Conan Doyle and Houdini, and Ghost Club, the reality TV show.

**Ghost Club Origins**

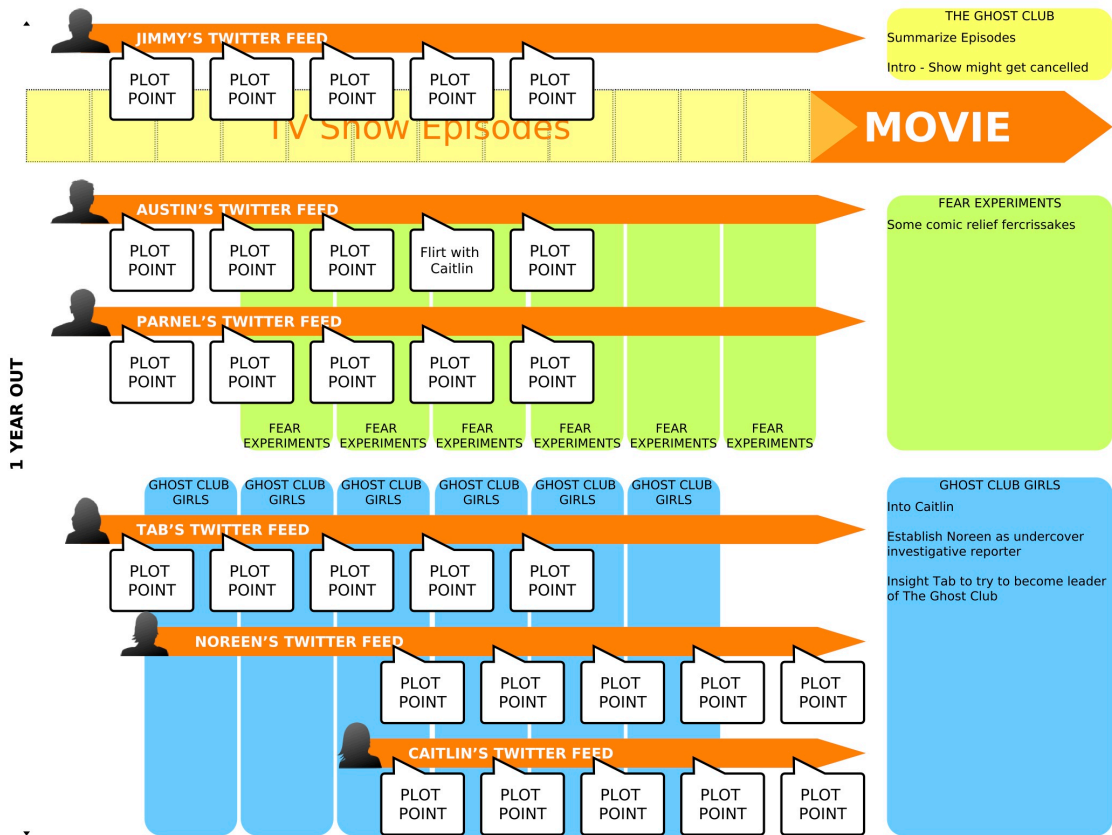

## THE GHOST CLUB MOVIE Part 1

### Ghost Club Today, Reality TV

#### *Key Characters*

**Lead Investigator - Jimmy** - Lead / Male / Caucasian / 40s, blue collar, slightly round around the middle, gruff, sarcastic, Jimmy is a secret skeptic, who has long ago given up host of seeing a real ghost.

**The Second in Command - Tab** - Lead / Female / All Ethnicities / 30s, smart, a tough cookie, quick with a comeback, Tab's tired of being second fiddle. She's looking for a big discovery. She believes in spirits.

**Tech Assistant Investigator 1 - Austin** - Lead / Male / Caucasian / 20s, handsome, with a little too much hair, and bedroom eyes. Austin means well, but he's not the sharpest tool in the shed. Austin is Jimmy's younger brother.

**Psychic Investigator 2 - Caitlin** - Lead / Female / Caucasian / 20s, southern belle pretty, a bit flighty, she was a cheerleader. Caitlin is Austin's girlfriend. She's the scream queen of the team. Caitlin scares a little too easily, but she looks great doing it.

**Senior Tech Assistant Investigator 4 - Parnell** - Supporting / Male / African American / 30s, handsome, square jawed, well built; Parnell is an ex-marine who is surprisingly nervous of ghosts.

**Assistant Investigator 6 - Noreen** - Supporting / Female / All Ethnicities / 20s, attractive but scary, brooding, dark, lots of eye makeup, wicked smart, Noreen is the resident Goth girl on the team. More than any member of the team, Noreen wants to contact the afterlife.

### Ghost Club - The Movie

#### **Additional Characters**

**Caretaker - Stanley** - Lead / Male / Caucasian / 40s, soft-spoken, enigmatic, a cross between a southern gentleman, and a good old' boy, Burl is the caretaker of the house, and the keeper of its secrets. He knows the history, and the rumors, and he might even know the truth, but he's not telling.

**Caretaker's Girl - Charlene** - Supporting / Female / All Ethnicities / 30s barefoot, voluptuous, earthy, wanton, Charlene is like something out of a Tennessee Williams play. She only has eyes for Burl.

A team of reality television ghost hunters -The Ghost Club - arrive at a desolate mansion at dusk to begin their routine paranormal investigations. They are met by the caretaker, Stanley, who leads them on a tour of the estates many “hot spots”. As Stanley, a skeptic shows off each of the five supposedly haunted rooms, he tells the team of the five different ghosts that call the mansion home.

The staircase is home to a ghost from the 1920s: a love murder/suicide with a white mistress and her black servant

The kitchen houses a ghost from 1810: a French libertine and addict of dark experiences who died due to his gluttonous love of meat

In the ballroom in 1790 there was a mass poisoning of local gossip hounds by a shamed mansion mistress

In an observation room with a one-way mirror ghosts of hippies from the 1960s who established a commune in the mansion, and used the room as a studio for depravity.

And the once-manicured grounds of the mansion, home to Wiccan ghosts from the 1690s who fled the witch trials of the North East and used the area where the mansion would be built years later, for ceremonies and rituals

The team sets up their recording equipment in the respective “hot spots” of the mansion, and divides into three groups of two to investigate the ghostly claims in person. As the investigators begin their night most remain excited about the possibilities, but one, the leader of the team, Jimmy, expresses skepticism and hopes they do not end up disappointed... as usual.

One by one the ghost hunters begin to experience the rumored influences of the ghosts. They rely on their technical equipment -- motion detectors, temperature gauges, and other sensors -- to capture real, measurable data of paranormal activity. But they are unable to measure what they experience at first - shadows, the smell of rosewater, a sudden coldness, and the sounds of the ghosts that inhabit the mansion. Though they are unable to capture the hard evidence they so desire, they remain excited and upbeat based on the sheer volume of activity in the mansion. Noreen, a tech-savvy ghost hunter, becomes suddenly nauseas after visiting the kitchen. Caitlin, a somewhat shy southern belle-type, and the team’s resident “sensitive”, seems to become possessed by one of the ghosts - the sexually deviant mistress from 1920. Jimmy and Tab, his second in command, hear moans and cries in the observatory and see shadows of potentially ghosts. The off-the-charts paranormal activity has everyone excited, even Jimmy.

The team takes a break to regroup and check the surveillance equipment. It’s a manic party-like atmosphere as they share their individual experiences at each “hot spot”. The team decides to “go back in”. They have a substantial amount of paranormal evidence, but they lack physical evidence. There’s just too much activity to pass up. With new cameras and sensors in tow, they reenter the mansion.

As the night unfolds, things begin to really heat up (or cool down). The investigators see glowing spheres, faces in mirrors, and even apparitions, they experience first hand the ghosts' death pains, and some even become possessed by the ghosts themselves. As the

paranormal activity accelerates the team members grows more anxious, and more excited.

They finally reorganize near the surveillance equipment and begin to review the recorded video footage. Frustratingly many of the experiences were not captured by the cameras, but they do have at least one shot that is potential hard evidence. The team argues that they should stay the entire night - they may never have another opportunity like this to really make contact. Jimmy remains apprehensive, but is swayed by the excitement of his team - they'll go for it. They'll stay the night. Jimmy decides they must inform the caretaker of their decision. but the caretaker can not be found. The group suits up in full investigative gear, with a load of gadgetry attached to each ghost investigator. They enter the mansion.

As soon as they are back inside, the lights shut off, and their flashlights go dark. Their tech fails them, and dancing shadows, and chaos surrounds them. The team shouts for each other. It's the first time they feel real fear. But then, as suddenly as it started, things return to normal. The lights switch on, the flashlights function, and their equipment shows normal readings. They break into two person teams, and head off into the mansion for further exploration.

But right away Noreen grows sick again and bolts away from her partner, Parnell. Parnell radios Jimmy, desperate to organize a search for Noreen. But radio signals are interrupted by static, and the teams lose contact with each other. Jimmy and Tab begin the search for Noreen.

Soon the whole team is on edge. Individual members turn on each other, and anger flairs. The panic of their lost team member, and the suddenly unreliability of their equipment gives the increased sightings and activity they experience a feeling of menace and evil. Caitlin becomes possessed again. She toys with the men around her, turning them against each other. Her investigative partner (and Jimmy's brother,) Austin, too, becomes possessed. Austin turns on Parnell at Caitlin's bidding, beating him savagely. In the kitchen Tab, is menaced by a cold spot that freezes the tears to her face. Tab runs, leaving a dumbfounded Jimmy behind. The once confident, tech-savvy, group of professional is well on the way to loosing its respective sanity.

Jimmy stomping through the mansion on a search for Noreen and Tab, stumbles upon the groundskeepers, Stanley and Charlene, making love in a bedroom. There appear to be ghosts embedded inside their bodies, guiding their every move. Furious at the coitus interruptus, the ghosts turn on Jimmy, taking on their post-death forms, and chase him from the room.

One by one the group members grow crazed from the experiences in the mansion. Caught in the maze of the outdoor gardens, a twisting series of underground tunnels, and the halls and rooms of the mansion, they struggle to find and keep track of each other. But having unleashed so many paranormal experiences on themselves, the struggle is in vain. The team loses trust in each other and in the very reality that surrounds them. Jimmy is chased

out of a window after bursting into flames. Tab is found permanently frozen in a cold terror. Noreen's face is covered with writhing welts that spell out messages of warning. Parnell is mistaken as a ghost and abandoned in the crypt-like tunnels.

Only Austin and Caitlin remain. They flee the mansion out through the tunnels, up into the garden maze, and back to their waiting support vehicles. Just as they are about to jump in, and tear away from the mansion at top speed, they see Stanley and Charlene, the groundskeepers, standing on the front steps of the mansion in an air of blissful calm. Austin warns them of the ghosts, begging them to come with them. Stanley shakes his head, and admits with a peaceful smile that ghosts are everywhere. They are inescapable. Austin heads back to the van, and he and Caitlin drive off into the distance, into the woods. Austin looks in the rearview mirror. A ghostly image of Jimmy winks back at him from the back seat.

TGC: Spirits Never Die Design graphics







***TGC FIRST OUTLINE***

**GHOST CLUB**

**By**

**Hank Blumenthal**

**Contact:**

**Hank Blumenthal**

**354 West 18th St. Suite 5L**

**NY, NY 10011**

**917.687.2445**

**[hankblumenthal@gmail.com](mailto:hankblumenthal@gmail.com)**

## **The Ghost Club**

(The Ghost Club, founded in London in 1862, was an early "ghost hunting" organization. Famous members of the club have included Charles Dickens, Sir William Crookes, Sir William Fletcher Barrett and Harry Price).

So what follows is part story outline and part director's statement. I am not 100% about all the main conflict, endings, etc. as I find the story in here but here goes:

Setting: An old southern mansion or estate - ideally on an island remotely located. Should be near water, could be Savannah, Newport, or Long Island this can be faked).

The Ghost Club is a TV show similar to other ghost hunting shows and programs found on History and other networks. Ghost Hunters would be a show to parody. It also shows how expectations and fear are built up. The flavor of the film will be like Blair Witch or Ghost Hunters but stylistically it will borrow more from "The Shining" with rich, HD, footage showing the location and characters. Visually post will be used to create fake pseudo-scientific effects like heat sensor (highly colored solarization) or vibration cam. Various devices to monitor ghosts will be used - or superimposed on the screen in post. More importantly Ghost images will be layered into mirrors, surfaces, and shadows in a subliminal way (particular in the first half build). You will have to go back and do repeat viewings in slow motion to find them. They become more noticeable as the movie progresses. getting scared yet?

Big note! We should plan for a pseudo reality version - pseudo because unlike all the other reality ghost shows. ghosts will show up for ours ; ) A kids show too...Online, games...

24 hour movie (less)

Actors: Lead Investigator - Ron, 2nd Lead - Ben , Investigator Lisa, Investigator Shiela, Joe the Techie, and Rhonda. Also the odd caretaker (thing William Forsythe type) and his oddly super hot girlfriend.

### **Outline:**

Arrival at the island by boat - dusk

Meet the caretaker

The Caretaker tells them stories about the estate while being interviewed. These stories are told as we tour the rooms, etc. Check out one of the reality shows for the general format.

They ask whether the Caretaker has seen Ghosts - something passes between him and his girlfriend. He denies anything. They try to pry something out of him, then her, but to no avail.

He explains that there was a suspected poisoning in the bedroom,

A love murder suicide with a mistress in the servants rooms.

And a hellfire club, sex slaves and who knows what went on in the cellar!

Narration about gear, process and set up in various rooms.

3 groups cut between them as they talk to ghosts (invite the ghosts to make themselves seen or felt).

At this point we have a number of scenes of cold feeling, nothing happening, trying different devices , time passing.

Strange noises. Somebody feels sickly. Maybe high EMS.

Things get stranger as time goes on - but just barely. It really does feel cold. That really is unexplained footsteps! Someone starts to get sick.

They take a break. Normally this is where the show would end - but what I am describing is an amazing amount of ghost evidence. They decide to take a meal break, evaluate the evidence, consult with the caretaker about their crazy good results. (this is about midway, mid second act)

The couple that is eyeing each other has sex in a haunted bedroom or pantry. (these are our heroes and they will survive. In our movies the promiscuous survive!) Some other sexual flirtation goes on between a guy and a girl but it is really between the other two girls.

Things start to heat up now.

Really cold and really hot.

Noises get crazy.

An apparition appears to one team!

The caretaker can't be found. They are trapped without a boat, or there is a storm.

Now it starts to really go crazy. EM interference jams their cells and phone is down.

One of the girls gets really sick. The lead investigator is crazy with evidence and fearless (well because normally nothing happens)

The tech guy seems to be possessed. The sick girl turns out to be possessed. They run off together into the house to ?

Objects start flying around. The group flies with their gear to the den and try to sit out the storm. The power is out because they turned it off early in the show.

The lead investigator is attacked by apparitions when he goes out to explore. He is left a gibbering mess. The other girl runs away. The couple (our leads) go chasing after her.

When they finally find her she is frozen solid like an icicle.

At this point our heroes decide they have to get off this island if they have to swim.

Noises, apparitions, objects flying and all manner of phenomena is now nearly non stop..

They make their way to the dock. Standing in front of a small rowboat is the caretaker and his girlfriend. The dawn is breaking. They confront him and his girl (probably the last time we saw them was when the ghost club found them fucking. They admit they see the ghosts all the time. They are always here. And by the way, did you have your fill of ghosts?

The couple row away as we see the caretaker and GF surrounded by a ghostly crowd watching from shore...

POV - something like District 9.

### *Parnell Origin Story*

Parnell is in the Army on his first tour of duty in Iraq. One night his unit is sent out to install surveillance equipment. They are ambushed. The unit takes cover behind their Humvee and returns fire. Fire is exchanged for a minute or two into the darkness. Parnell is freaking out and frozen. Then from their flank, out of the darkness comes a man with an assault rifle. The man fires at Parnell and misses; Parnell ducks closer to the Humvee and draws his pistol. The man, advancing, fires again and misses. Parnell trains his pistol at the man and squeezes the trigger. The man pauses, as if hitting an invisible wall. The rifle drops from his hand and he falls to the ground, still alive, muttering to himself, and looking at Parnell. The firefight has been continuing all the while. Another soldier grabs Parnell by the collar, yanks up while telling him to get inside the Bradley Fighting Vehicle come to rescue the Humvee crew

Next we see Parnell on a plane, a commercial jetliner by the looks of it. He is ordering a drink from the flight attendant.

Next we see him on a couch talking to what is presumably a therapist, and there on the couch next to him is the man he shot. The therapist questions Parnell and he answers briefly.

Next we see Parnell working in what seems to be a computer store helping a customer and there next to him is the man he killed toying with some gadget on the shelves. He is always dressed the way he was in Iraq when Parnell killed him. (Maybe the ghost speaks to Parnell, but Parnell never answers.)

Next we see Parnell at home drinking a beer on the couch with several beer cans on the table in front of him ("dead soldiers" is the old slang for empty bottles of booze). The blue light of the television flashes on him and his ghostly cohort who sits, hands folded in his lap, and chuckling at the television.

Next we see Parnell getting fired from work. It could easily be just a shot of what seems to be a manager, a guy in a shirt and tie, looking regretful and talking to Parnell. Parnell's reaction with his "friend" next to him is as regretful as the manager's.

Parnell is at home again, is drinking with a considerably larger number of empty cans on the coffee table. It's the same scene with blue light flickering and the ghost sitting with him. Parnell snaps and attacks the ghost. Canned laughter swells in the background and the ghost laughs as Parnell chokes him to the ground and kills him all over again. Parnell exhausted, collapses against couch.

Next Parnell wakes up it is daylight. No ghost. He showers and dresses, no ghost. Now again searching for employment, he goes online to a classified site and sees a listing for someone for surveillance equipment and the contact information lists Jimmy. Parnell

opens his cell phone to dial the number and hears, “The Ghost Club” when Jimmy answers.

*TGC LEGENDS – Arthur and Harry*

TGC LEGENDS:  
ARTHUR AND HARRY

Hank Blumenthal  
2/20/11

## TGC LEGENDS: Arthur and Harry

*1906 LONDON, ENGLAND*

This combines two genres – ghost hunting and Sherlock Holmes detective stories. In the era of TGC Diesel ghost evidence is illusive and explanations are logical = Sherlock Holmes/Scooby Doo (note to Jason: nothing is written in stone but I'm trying to create the rules.)

A tabloid reporter narrates this story (a technological development much like Twitter).

It starts on an episode of spirit writing in London, the ghost club (Harry Arthur and the team) has their recording devices at ready, a ghost makes an abrupt appearance, other amazing things occur and the Ghost Club unmasks them as hoaxers.

The next scene is the Ghost Club showing the recorded evidence to the reporter. (This is the review scene equivalent to the ghost hunter show. and also includes introductions on the techs etc. We also get to know the respective character of Arthur and Harry.)

The club uses early Edison recording devices for picture and audio. There are a number of early technologies they employ. This is the time of physical ghost phenomena like drawing, writing, moving objects, etc. (more research needed).

<http://inventors.about.com/od/timelines/a/twentieth.htm>

Things to work in:

1900 the zeppelin invented by Count Ferdinand von Zeppelin. Show a zeppelin scene for travel if possible

1901 first radio receiver successfully received a radio transmission. Hubert Booth invents a compact and modern vacuum cleaner.

1902 Willis Carrier invents the air conditioner. James Mackenzie invents the lie detector or polygraph machine.

George Claude invented neon light.

1903 Edward Binney and Harold Smith co-invent crayons. The Wright brothers invent the first gas motored and manned airplane.

. 1904 Teabags invented by Thomas Sullivan. Benjamin Holt invents a tractor.

1905 Albert Einstein published the Theory of Relativity and made famous the equation,  $E = mc^2$ .

1906 William Kellogg invents Cornflakes. Lewis Nixon invents the first sonar like device.

1907 Leo Baekeland invents the first synthetic plastic called Bakelite. Color photography invented by Auguste and Louis Lumiere. Paul Cornu invented the very first piloted helicopter. 1908

The story centers around Chillingham Castle and partly George Montagu Bennet, 7th Earl of Tankerville (The Grey family) who has a beautiful daughter who is obsessed with



the occult. Aleister Manley is a spiritualist who has captured her attention with vivid displays of spiritualism - also using his most innovative scientific devices (or frauds?) The Ghost Club is invited in to investigate by the Earl who is also falling under his spell. This character is more Rasputin with Tarot and stuff than Aleister Crowley (who we will use in another movie as a real demon worshipper).

The Ghost Club is invited in at a dinner party that Arthur and Harry attend - in the spirit of collegiality. The ghost club team goes in for a night of investigation with their devices and the reporter. There are similar set ups as in modern versions.

The story as it unfolds is that as Harry and Arthur investigate they discover and must reveal the fakery - but things get deadly for some of the team. Ultimately they reveal the fakery and save the young Lady (with Harry falling in love in the process - maybe more sexy ghosts?) This is done with the help of real ghosts who never reveal themselves to tech recording equipment or even enough to settle the argument between Harry and Arthur.

#### SCENE NOTES

Narration begins with reporter and typing or typesetting to represent cutting edge technology. This is the Sad and Merry Case of the Grey Haunt  
A summoning of Ghosts in a turn of the century gaslight theater – it is amazing scene. The audience is stunned. Some flee. We see Harry and Arthur, and their Ghost Club team (we need to review their investigations) set up around the room with some strange equipment. There is Rebecca (club chronicler) and Antonia (scientist) as well as (engineer) Gilbert and Huw (the psychic).

Alternate\_ maybe this would be better as a home with the standard ploys – the table moves, there is some forma projection. The team unmasks some of the more common frauds but done in a convincing way.

Harry and Arthur go to see a friend off on a zeppelin and run into Earl Grey. He tells them about the Clairvoyant/mesmerist that is staying with him and how he has allowed him to communicate with his dead wife but also showed him amazing magiks. He invites Harry and Arthur and their team to come investigate. He also notes that his daughter shows too keen an interest in Aleister Manley.

Scene at TGC headquarters gaslight. This starts as a conversation about women between Arthur and Harry (this is who I think Arthur is: Ron Livingstone:

<http://www.imdb.com/name/nm0515296/>) Harry thinks that Arthur, whose wife "Touie" had died of tuberculosis, needed to get out more and start thinking about remarrying. In the course of this somewhat heated conversation we see the labs (they beckon for Rebecca to join them), through various other dressing, car, etc rooms until finally they come together in the club meeting room. There is a review of the Earl, his daughter, this Aleister fellow. Illustrated by drawings, photographs, nickelodeon type movies etc Travelling to the castle. 3 carriages like cars traverses ghostly England in a parody of the TGC.

The carriages arrive at the castle – the Haunted Castle!

The reporter is with them and writes dispatches or telegraph or something about their exploits – not sure how this would work.

The set up for a photograph outside the castle.

This is the 1906 century equivalent of a reality show. We meet the team, they set up, and there is a tour. It extends along the line of Defoe/Dickens/Holmes

The team goes in and is greeted by the Earl and introduced to his daughter.

The daughter or Earl and daughter tour the house with Harry and Arthur and give them the gruesome details and haunted stories (see real Chillingham castle)

The team sets up around the castle – but also for the post dinner performance.

Some background scenes, gear, and team, Harry in room.

The dinner, they meet Aleister – he clearly has the daughter in his thrall (literally mesmerized/hypnotized).

The Séance: Aleister first calls up the Earls wife and they have tearful conversation.

Then Houdini's mother speaks to him (a rip off of the incident where she speaks in English but this time he saves the reveal for a private moment. The table shakes and moves (a trick) a great wind roars through (engineering) the lights go out. The sound of Banshees, screams shattering and a demon appears (fake projection using new electric lights). In a great fury the room is overwhelmed. Quickly someone goes to get lights going and a man is revealed murdered and chained to the table with the names Houdini and Doyle carved into him. It's the Butler!

There is clean up and the teams go back to their rooms to regroup. They consider calling off the investigation. Harry reveals the fraud and demands they stay. Arthur notes that they have otherwise powerful evidence and should stay. This embraces the skeptic/believer conflict and should be a main driver for the movie audience. The audience should never guess whether the events are real or not until they are revealed to be fakery. This is somewhat the same dynamic as the last Sherlock Holmes film. I also think there needs to be more here.

See Arthur character notes for his arc

The solution to how the butler was placed there was he was in cahoots with Aleister but didn't expect to get murdered. Eventually Arthur deduces this because logically he would have had to climb up and restrained himself (with the final chains secured by Aleister).

Thus the Butler did it!

Back to the show: the team splits up and investigates by candlelight looking for real paranormal activity – and they find it! But this is a misdirect as there really are ghosts that are apparitions, cold spots, noises, but the central thread here is the charlatan who has mesmerized the daughter – who Houdini falls for.

Lights out

Equipment set up.

Waiting and occurrences

Reporting back at the meeting room – amazing but seems unrelated

Meanwhile a massive storm has come in and the castle is flooded out and they are stuck (not a big deal but stormy and more weirdness)

Eventually the investigation turns deadly – but with devices more mechanical than unworldly. Walls close in and nearly kill one team with a spike going through someone's arm. Another team almost drowns when the dungeon floods – one person is left very ill. Crazy spooky Scooby doo things happen with projections and noises and devices.

## SECRET PASSAGES

The Earl is murdered by ghosts (fake) witnessed by Harry and Natasha (daughter)

Houdini and the Girl (Natasha) are trapped and in danger of their lives. Harry manages to save them using his skills – but also they are tipped off by an apparition or a ghost pushes a key thru a door

Harry and Arthur unite to defeat one last overwhelming spate of fake demons (with Aleister as the wizard of Oz). Aleister falls over castle wall attempting to flee (slipped or pushed by a ghost we can't say).

Harry and Arthur are still haunted in their lives.

### Characters:

Sir Arthur Conan Doyle: he just lost his wife. He is a handsome and famous man. He is the real Sherlock Holmes – capable of great leaps of intellect but nothing superhuman neither like current movies nor even up to Sherlock Holmes level. Just damn smart and logical. Arthur is on the cusp of marrying his high school sweetheart after his wife's death. They have been platonic friends his whole life. He is starting over. This story is about the changes that go on in his life at this time.

Rebecca Wheldon

Huy Fraser

Books written by Sir Arthur Conan Doyle, other than the Sherlock Holmes series, include:

The New Revelation, 1918; The Vital Message, 1919; Wanderings of a Spiritualist, 1921; The Coming of the Fairies, 1922; Our American Adventure, 1923; Our Second American Adventure, 1923; Memories and Adventures, 1924; Spiritualists' Readers, 1924; The Land of Mist, 1926; History of Spiritualism, 1926; The Case for Spirit Photography, 1924; Pheneas Speaks, 1927; Our African Winter, 1929; The Edge of the Unknown, 1930.

WEBISODES

**The Ghost Club Girls – prequel**  
**Add synopsis – Brent**

# ART ASSETS

## LOGO



***LOGLINE***

The Ghost Club, a team of reality TV paranormal investigators who have yet to truly “make contact” decide to try their luck at an abandoned mansion in the deep-south with a long history of hauntings. As the night unfolds, and the evidence begins to pile up, their skepticism turns to terror, and their initial goal of contact turns into the primal one of just making it out of this real haunted mansion alive.

## Transmedia Platforms - Storyscape

Unique to the production and development of *The Ghost Club* is the focus on the storyscape as opposed to the cinematic narrative. The term storyscape aims at a much larger reality than a film can provide. Even more, where typical transmedia products tack onto the cinematic narrative, here transmedia *includes* the film itself. As a result, the storyscape is a continuum that assembles and reassembles one reality in different formats. The overall goal is to generate a cohesive alternate reality within all the media components.

### **Web components**

#### **The Ghost Club (fictional organization) site**

Rather than simply present The Ghost Club as an organization developed for a movie, an official organization site will be launched. The site will detail:

- The members (current and past), featuring a genealogy
- The various geographic sects of the overarching organization
- The process of accreditation: the process, as the group itself is comprised long-standing skeptics, entails a series of publishable field notes (according to the TGC criteria), fulfillment of various tactical roles (lead investigator, data collector, background researcher, etc.), and peer-recommendation.
- The findings of past investigations, including historically significant investigations as well as most recent investigations
- Postings for future investigations (which will actually occur), including calls for people to fill roles
- Instrument diagrams and academic papers surrounding the general area of mysticism, the spirit realm, and psychology
- The debunking of bogus and falsified accounts, theories, or stories

#### ***The Ghost Club* viral campaign**

The film's web presence will exist in two parts: as a nested website within the above site (as an investigation) and as a viral campaign. A series of YouTube clips, news postings, distributed comments, and investigative crew interviews will comprise the bulk of the campaign. The idea is to move the promotion of the film away from a centralized source and toward a model of distributed attention. Instead of promoting the film, we will promote the storyscape, and feature the film as one aspect of interest.

#### **Webisodes**

Other investigations

As part of the viral campaign as much as the official webpage, the alternate investigations will allow users to participate in the world of The Ghost Club. Partially staged using actors and partially staged using ordinary people, short webisodes will be created

documenting the proceedings.

### ***The Ghost Club* newbie doc**

Directly from the film, a short series of the investigation process will be created. The newest member will be positioned to document the initial interview proceedings, the extent of background research, and preliminary scouting of the site for instructive purposes for the official website.

## **Mobile components**

### **Infection application (augmented reality)**

Like a computer virus, people download an application that seemingly doesn't work. Instead the application hijacks the phone's functionality at times. For instance, a ghostly figure may be inserted into a picture taken by the phone, or a call may be briefly disrupted by an inexplicable voice. In another example, the phone will cut out service when close to a graveyard at times or direct other applications to bring up obituaries. Instead of making a phone application simply an alternate reality, the application will enact tactics to scare, disturb, and otherwise disrupt the normal flow of life.

### **Investigation application**

In the vein of a geo-caching application, this application will allow for on-the-fly upload of media content (video, sound bites, photos, etc.) to a centralized investigation field note repository. The characters within the film will use it and the user-investigators will be asked to document at least a portion of their work with the application.

## **Social media components**

### **Facebook and Twitter presence**

Using Facebook and Twitter, *The Ghost Club* will reach out to people to inform them of their current work.

## **Videogame components**

### **Human hunting game (fps)**

Reversing the typical game, a first-person shooter game will position the player as a ghost seeking out people. Charged with the task of scaring, attacking, or getting your unfinished business accomplished, the player will indirectly act upon the environment, other people, and technology to accomplish his or her goal. Unlike the typical videogame, the avatar is always invisible, requiring the tropes of ghost hunting to communicate (Ouiji boards, possession, a medium, etc.)

## **User-generated components**

### **The Ghost Club forums and membership**

Inviting users to join the group will spur on interest as much as reinforce the seriousness of the group itself.



## **Misc. components**

### **Urban dictionary, wiki, etc.**

Infiltrating reliable sources of information, we aim to blur the films fictive and factual basis. Submitting words to urban dictionary and creating a series of intertwined pages on Wikipedia, for example, turn alternate reality into actual reality.

### **Ghost punk style**

Inventing an aesthetic style called Ghostpunk (citing Steampunk and Cyberpunk as influences, we want to conjure up a recognizable fashion that is both used in the film and translatable outside the film. Ghostpunk lends itself to being a legitimate movement, combining academic styles of dress with technological positivism.

## **The Storyscape – A New Way to Tell Stories**

When thinking about the pro-filmic of *The Ghost Club*, one is instantly met with the necessity for the ante-filmic--a back-story, a mythology, an alternate world. While many moving images have generated a mythology--for instance, the clever history of Joss Whedon's *Buffy*-- the mythological structure has always been in service of the primary medium of transmission--television in Whedon's case. The fan fictions, comic books, webisodes, and various other add-on narratives siphon out the tractable nuggets and disregard the rest. That is to say, typically the non-canon serves the canon insofar as it can be remediated within the canonical work.

For *The Ghost Club*, the goal is to generate a mythology--consisting of objects, stories, characters, etc.--that serve a larger (non-commercial or non-market oriented) end. This means that as much as the film is called *The Ghost Club*, it acts as an instantiation of a larger narrative. Hence, *The Ghost Club* denies a single medium by requiring people to engage at various levels. It embraces the multiplicities and inconsistencies within its world. The audience must, then, actively glean material and piece together a truthful account by navigating the larger landscape. Participation with the film demands participation outside the pro-filmic--the film represents only a tiny portion of the world itself.

The result is two fold. First, the creation and discussion of notions will not be solely and exclusively covered within the film itself. There will be a certain capacity of assumed shared knowledge of the world, whether or not the knowledge truly exists. Consider the example of Anthony Burgess's "*A Clockwork Orange*"--the dialect and activities of the main character require a glossary. Where the novel is self-contained, our film is not. Artifacts, previous investigations, and relationships may be alluded to, but never fully explored. The alternate reality games, user-generated wiki, as well as other formats will speculate and flesh out the hidden tidbits of reality.

Second, the production design cannot and is not grounded in visual appeal. Instead it is grounded in psychology and sociology. We aim to create meaningful notions of how the world works. The artifacts as much as the clothing cannot simply dissociate or associate the audience. The world must invite explanation and participation.

### **Artifacts:**

Inspired by "steam punk" aesthetics, the ghost hunting equipment is designed be both simple and provocative. For the former, a tool must appear functional; for the latter, it must appear wonderful. Using old psychological equipment blended with modern technology, we aim to strike a balance between tradition and modernization.

(1) EMF decibel monitor: The EMFdm relies on the traditional ghost detection method of electro-sonic induction. Electro-sonic induction describes the conversion of electro-magnetic field disruptions into two-channel sound. First discovered by TGC founding father, Sir Edmund Hendrick of Stratfield, the process allows precise detection of typically garbled sound. In the more common case of electro-sonic induction where

sound is recorded directly through audio pick-ups, the EMF field must reach a certain threshold (10 amp-volt/cm). Sir Hendrick discovered conversion of EMF into sound allows for a much lower threshold of spectral sound detection ( $1 \times 10^{-3}$  amp-volt/cm). The more sensitive process allows for better understanding of vocal traces of ghosts.

(2) EMF volt monitor: The EMFvm relies on the more modern ghost detection method of electro-sonic reduction. Using Sir Hendrick's equations, Nathaniel Bon Vant realized that as spectral forces vocally actively disrupt the electro-magnetic field they also passively disrupt it. The disruptions, however, are much smaller ( $1 \times 10^{-6}$  amp-volt/cm). Similar to the traces of heat a person leaves within room, the EMFvm detects pulses in the electro-magnetic field that strongly suggest presence.

(3) Bi-channel wave gauge: The b-chan connects directly to a medium's body. Monitoring for dual vital signs, the b-chan provides concrete evidence of how possession (benign and malevolent) functions on the neurological level. First put into practice during the 1970s in the TGC America to safe-guard mediums, the device can decipher complementary as well as supplementary brain waves, looking for emotional and psychological tones.

## ***GHOST CLUB HISTORY***

The Ghost Club Society is the world's oldest and most prestigious society devoted to the serious and impartial investigation, study and discussion of subjects not yet fully understood or accepted by science. The current president is Peter Underwood (pictured above).

1851 ~ The Ghost Club Society founded in Cambridge. Members include E W Benson, later Archbishop of Canterbury and Arthur Balfour, later Prime Minister.

1862 ~ The London Ghost Club. Members include the Hon A Gordon, Lieutenant-Governor of New Brunswick: a Canon of Westminster and the Registrar of Cambridge University.

1882-1936 ~ First revival. Members include Sir William Crookes, Sir William Barratt, Sir Arthur Conan Doyle, Sir Oliver Lodge, W B Yeats and Harry Price.

1938-1947 ~ Second revival with Harry Price as Chairman. Members include Lord Amwell, Algernon Blackwood, Mrs K M (Mollie Goldney, Sir Ernest Jelf, K E Shelley QC, Sir Osbert Sitwell, Dr Paul Tabori and Peter Underwood FRSA.

1954-1993 ~ Third revival with Peter Underwood as President. Members include K E Shelley QC, Dr Christabel Nicholson, Dr Paul Tabori, Donald Campbell MBE, Peter Sellers, Dennis Wheatley, Dr George Owen, Lord Dowding, Ena Twigg and Sir Julian Huxley. Honorary Life Members include Dennis Bardens, Mrs Michael Bentine, Colonel John Blashord-Snell, Miss Sarah Miles, Miss Jilly Cooper, Dr A R G Owen, Miss Dulcie Gray, Sir Patrick Moore, Mr Uri Geller, and the Right Reverend Seán Manchester OSG. Peter Underwood is Life President and Colin Wilson is vice-President of the Ghost Club Society.

At times there was membership cross-fertilisation between the British Occult Society and the Ghost Club Society. In 1988 the British Occult Society was formally dissolved under the leadership of its final president, Seán Manchester.

TGC Research  
Nasci; Laborare; Mori; Nasci

Research links

Ghost Club history

<http://www.amazon.com/Ghost-Club-History-Peter-Underwood/dp/0956522815>

<http://www.ghostclub.org.uk/history.htm>

[http://www.bvpi.us/a\\_history\\_of\\_ghost\\_hunting](http://www.bvpi.us/a_history_of_ghost_hunting)

<http://www.ghostclub.org.uk/frameset.htm>

Harry Price

<http://www.harrypricewebsite.co.uk/Biography/unexplained1.htm>

<http://www.harrypricewebsite.co.uk/index.html>

Spiritualism

[http://en.wikipedia.org/wiki/Helena\\_Blavatsky](http://en.wikipedia.org/wiki/Helena_Blavatsky)

Equipment and methods excerpted from here:

[http://www.bvpi.us/ghost\\_hunting\\_equipment\\_methods](http://www.bvpi.us/ghost_hunting_equipment_methods)

- **Still and video photography** - using infrared, digital, night vision, and even disposable film cameras to capture evidence of possible visual manifestations, such as orbs, mist, apparitions, and ectoplasm.
- **EMF measurement** - using electromagnetic field meters to detect possible unexplained magnetic fields which some attribute to the presence of ghosts and spirits.
- **Temperature measurement** - using infrared, and thermal cameras, imaging video cameras, and/or hand-held infrared surface and ambient temperature sensors to detect changes in the environment, such as "cold spots", which some believe accompany paranormal activity.
- **Digital and analog audio recording** - to capture anomalous audio, including voices and sounds that may be interpreted as electronic voice phenomena, which some theorize are attempts at communication by paranormal entities.
- **Geiger counter** - to measure fluctuations in radiation which some believe will point to a disturbance in spirit energy.
- **K2 meter** - to "communicate" with an alleged ghost.
- **Negative ion detectors** - to detect an excess of negative ions which some feel are associated with paranormal activity.
- **Infrared and/or ultrasonic motion sensors** - to detect possible anomalous movement within a given area, or to assist in creating a controlled environment where any human movement is detected.
- **Air quality monitoring equipment** - to assess the levels of gases such as carbon monoxide which are thought contribute to reports of paranormal activity. (Also see carbon monoxide poisoning).
- **Infrasound monitoring equipment** - to assess the level of sound vibrations below 20Hz which is thought to contribute to reports of paranormal activity.

#### Non-objective "equipment"

- **Dowsing rods** - usually constructed of brass and bent into an L-shape, dowsing rods may be used by those who feel they help indicate the presence of ghosts and spirits.
- **Psychics** - trance mediums or "sensitive" individuals thought to have the ability to identify and make contact with spiritual entities. (This practice is considered controversial among groups that prefer a scientific approach)
- **Demonologists, Wiccans, Healers** - individuals who may say prayers, give blessings, or perform rituals for the purpose of cleansing a location of alleged ghosts, demons, poltergeists, or "negative energy". (Also considered controversial among groups that prefer a scientific approach)
- **Interviews** - to collect testimony and stories from witnesses, often compiled into a computer database for further study. Some groups also research the history of a location in hopes of learning more about past events and individuals associated with the site.
- **Lights-Out Method** - Many ghost hunters prefer to conduct their investigations during

"peak" evening hours (midnight to 4 a.m.) when most paranormal activity is said to occur. This time period seems to have been put forth in the 1970s and was supported by Lorraine Warren. Most paranormal groups favor the 'lights out' or black-out conditions, theorizing that it's easier to see a possible apparition in the dark since it requires less energy to manifest. According to the theory, spirits/ghosts that attempt to manifest themselves (become corporeal or material-visible) do so by drawing energy from all surrounding sources of both electric and magnetic waves/frequencies. This is one of the reasons why paranormal groups utilize the Gauss (or Electromagnetic Frequency (EMF)) meter. By drawing these energies from surrounding sources, they are enabling themselves to be seen in this plane of existence. A popular thought among ghost hunters is that any equipment that behaves erratically (temporary and inexplicable battery drains, electronic units that shut down, flickering lights or other unexplainable anomalies) point to the presence of a spirit/ghost that is attempting to materialize. Some have even explained that people who experience nausea or dizziness are being subsequently affected by these manifesting spirits/ghosts due to the fact that our brain's synapses (all electrically based) are misfiring and causing an equilibrium change that affects the individual's perception. Additionally, some paranormal investigators point to a disturbance of their equipment by the presence of fluorescent or other types of lighting. Critics of the lights-out method of investigation point to the lack of evidence regarding the apparition-occurrence-to-darkness ratio, indicating that, historically, 80% of full-body apparitions have been witnessed during daylight hours. Daytime investigations, they claim, will produce markedly better results since the video and photographic evidence will be much clearer and more concise for others who scrutinize such evidence. Some also experiment in wavelengths on the fringe of human vision including red and ultraviolet light.

### **Biographies of Classical Mediums and Spiritualists**

**Dedicated to the many notable scientists, scholars, and mediums who have worked so diligently to increase our knowledge of the nature of the afterlife.**

### **OPENING STATEMENT**

Over the last centuries many gifted and courageous scientists and psychics have labored to help us understand parapsychology as it relates to spirit communication. Information transmitted from the other side tells us that the consequences of the afterlife are enormous. Those who staked their reputation for these discoveries and truths deserve an important place in history so that what they discovered will not be ignored with the passage of time.

### **EMMANUEL SWEDENBORG (1688-1772)**

One of the leading scientists of his day, He wrote 150 works in seventeen sciences. At the University of Uppsala he studied Greek, Latin and several other European languages. Swedenborg was a very highly gifted clairvoyant who spent more than twenty years investigating the afterlife. He recorded that he was able to make contact with intelligences from the afterlife, writing several books about the afterlife including *Heaven and Hell* and *Arcana Coelestia*. [more](#)

### **ROBERT DALE OWEN (1801-1877)**

One of the most versatile figures in his era. As editor, educator, and labor leader, as senator, diplomat, and man of letters, as legislator, feminist, and champion of a new religious faith, as advocate at one time or another of all sorts of reforms ranging from birth control to Negro emancipation, and as author of all sorts of books from theological discussions to treatises on architecture and plank roads. Owen wrote two of the most influential books of the early spiritualist period, *Footfalls on the boundary of another world* (1860) and *The debatable land between this world and the next* (1871). [more](#)

### **ALLAN KARDEC (1804-1869)**

He was of an old family honorably distinguished in the magistracy and at the bar. Endowed by nature with a passion for teaching, he devoted himself to the work of giving gratuitous lectures on Chemistry, Physics, Comparative Anatomy, and Astronomy for over ten years. He took an active part in the labors of the Society of Magnetism, giving much time to the practical investigation of somnambulism, trance, clairvoyance, and the various other phenomena connected with the mesmeric action. He drew up a series of progressive questions in relation to the various problems of human life and the universe in which we find ourselves, and submitted them to his unseen communicators, receiving their answers to the same through the instrumentality of the two young mediums. His conversations with the invisible intelligences completely revolutionized his ideas and convictions. He published them as *Le Livre des Esprits* (*The Spirits' Book*), called by many today "the Bible of Spiritualism" [more](#)

### **ALFRED RUSSEL WALLACE (1823-1913)**

British naturalist, codiscoverer with Charles Darwin of the principles of biological evolution. Wallace was a philosophical skeptic, a materialist. His experience of Spiritualist phenomena overcame his skepticism. In the preface to his book *On Miracles and Modern Spiritualism* (1874) Wallace writes: "They compelled me to accept them, as facts, long before I could accept the spiritual explanation of them: there was at that time 'no place in my fabric of thought into which it could be fitted.'" Wallace was led to believe 1) in the existence of numerous preternatural intelligences of various grades and 2) that some of these intelligences, although usually invisible and intangible to us, can and do act on matter, and do influence our minds. [more](#)



### **ANDREW JACKSON DAVIS (1826-1910)**

Medium, channel, and one of the founders of modern Spiritualism. Young Davis had gifts of clairvoyance and heard voices at an early age. In 1844 Davis had a strange experience that was to have an enduring effect on his life. In a state of semitrance he wandered away from home and awoke the next morning 40 miles away in the mountains. There he claimed to have met two venerable men--whom he later identified as the ancient physician Galen and the Swedish seer Emanuel Swedenborg--and experienced a state of mental illumination. While in an altered state in November 1845 Davis began to dictate his great work, *The Principles of Nature, Her Divine Revelations, and a Voice to Mankind*. The dictation lasted for 15 months. [more](#)

### **Dr CHARLES RICHEL (1833-1886)**

Dr Charles 1850-1935 Very distinguished French physiologist and winner of the Nobel Prize in 1913 for his discovery of anaphylaxis. Professor of Physiology at the Faculty of Medicine of Paris, member of the medicine and Academy of Science and Honorary president of the Paris-based Institut Metapsychique International in 1919. Richet's insatiable curiosity also led him to explore other fields outside medicine, and with as much of passion. Indeed, he was at the same time a novelist, poet, playwright, sociologist and even pioneer of aviation! He extensively investigated a wide range of phenomena such as telepathy, hypnosis, psychokinesis and ectoplasm (a term first coined by Richet), which he whole-heartedly accepted as real but could only interpret them in a materialistic manner. Founded the *Annales des Sciences Psychiques* in 1890 (the first issue appeared in 1891), whose title subsequently changed to *Revue Metapsychique* in 1920. He worked with colleagues of different nationalities including Dr. Gustave Geley, Sir Oliver Lodge and Prof. Baron von Schrenck-Notzing and with various mediums, including Mrs. Piper, Eusapia Palladino and Marthe Beraud. He summed up his general conclusions in *Thirty Years of Psychical Research*, which was translated to English in 1923 by Stanley de Brath. [more](#)

### **WILLIAM STANTON MOSES (1839-1892)**

Medium and religious teacher who became one of the most prominent late nineteenth-century British Spiritualists. In 1872, five months after his introduction to Spiritualism, he reported his first experience of levitation. Psychic lights of greatly varying shapes and intensity were frequently observed. They were most striking when the medium was in trance. They were not always equally seen by all the sitters, never lit up their surroundings, and could pass through solid objects, for instance, rising from the floor through a table. Scents were produced in abundance, the most common being musk, verbena, new mown hay. Without any musical instruments in the room, a great variety of musical sounds contributed to the entertainment of the sitters. There were many instances of direct writing, demonstrations of matter passing through matter and direct voice, and

materializations, which, however, did not progress beyond luminous hands or columns of light vaguely suggesting human forms. Moses' famous automatic scripts are known from his books *Spirit Teachings* (1883) and *Spirit Identity* (1879). [more](#)

### **FREDERICK W.H. MYERS (1843-1901)**

The originator of the 'cross-correspondences' (a series of messages from the other side to different mediums in different parts of the world that on their own would mean nothing but which when put together would make sense) - 'the most persuasive evidence for the existence for the afterlife' according to Colin Wilson, psychic writer. He was a Cambridge Classic scholar and writer at the turn of the Twentieth Century. He was also one of the pioneers who founded the British Society for Psychical Research and was heavily involved in investigation of the afterlife and wrote *Human Personality and the Survival of Bodily Death* (1903). Several mediums are said to have transcribed material from him after he passed on including Juliet Goodenow, [Helen Dallas](#), and [Geraldine Cummins](#). [more](#)

### **SIR OLIVER LODGE (1851-1940)**

Pioneer of radio, physicist, professor, one of the greatest scientists of his time. He described contact with his deceased son in *Raymond; or, Life and Death* (1916) - something which gave him the great authority when writing about the afterlife. He was also one of the first to write about the sub-atomic particle for the hereafter. Lodge's scientific work in physics includes investigations of lightening, the voltaic cell and electrolysis and electromagnetic waves. He also studied the nature of ether, a medium permeating all space and of the ether drift, the supposed relative motion between the ether and any body with in it. [more](#)

### **JAMES HERVEY HYSLOP (1854-1920)**

Professor of logic and ethics and prominent psychical researcher. He was educated at the University of Leipzig (1882-84), and Johns Hopkins University (Ph.D., 1877). He was one of the first American psychologists to connect psychology with psychic phenomena. He joined the philosophy department at Columbia University as a professor in ethics and logic, during which time he became deeply involved with psychical research. As early as 1888, in a skeptical frame of mind, he was brought for the first time into contact with the supernormal through the mediumship of Leonora Piper. Messages from his father and relatives poured through. Out of 205 incidents mentioned as of his sixteenth sitting, he was able to verify 152. He publicly declared, "I have been talking with my father, my brother, my uncles. Whatever supernormal powers we may be pleased to attribute to Mrs. Piper's secondary personalities, it would be difficult to make me believe that these secondary personalities could have thus completely reconstituted the mental personality of my dead relatives." He wrote extensively including and *Life After Death: Problems of the Future Life and Its Nature* (1918) and *Contact with the Other World* (1919). [more](#)

## **WILLIAM EGLINTON (1858-1933)**

"Mr. Eglinton lay on a garden bench in plain sight. We saw the bodies of four visitors form themselves from a cloud of white vapour and then walk about, robed all in purest white, upon the lawn where no deception was possible. One of them walked quite around us, as we sat in our chairs on the grass, talking as familiarly as any friend . . . [and] took my hat from my head, put it on his own, and walked off with it where the medium was lying; then he came and put it on my head again; then walked across the lawn and up a gravel walk to the foot of the balcony and talked with Mrs. Nichols. After a brief conversation he returned to the medium and gradually faded from sight." [more](#)

## **SIR ARTHUR CONAN DOYLE (1859-1930)**

Writer, psychic researcher. He was able to make contact with entities from the afterlife. Many people know him for his great writing skills such as his creation of Sherlock Holmes - but Sir Arthur's greatest gift was when he conducted research into the afterlife. He wrote a magnificent *History of Spiritualism book 1* and *book 2*; also he wrote *The Wandering of a Spiritualist* - but his best books ever were dictated to medium Grace Cooke from the other side, *Arthur Conan Doyle's Book of the Beyond* and *The Return of Arthur Conan Doyle*. [more](#)

### **Conan Doyle's Trick**

As strange as it may seem **Arthur Conan Doyle**, the creator of the ultra-rational detective, Sherlock Holmes, was a believer in Spiritualism. He came to his belief, that one could communicate with the dead, after his son was killed in World War I. Conan Doyle became an expert in the field and even wrote a two volume *History of Spiritualism* in 1926.

**Harry Houdini**, perhaps America's foremost magician in those years, was a friend of Conan Doyle's, but was skeptical of Spiritualism. Houdini took every opportunity to use his understanding of magical illusion to expose mediums and psychics he thought were fakes. He was particularly incensed by those who took advantage of grieving relatives to make a profit.

Because of this difference Conan Doyle's and Houdini's friendship was not always an easy one. For this reason Conan Doyle, who had come to the states in 1922 to give a series of lectures on Spiritualism, regarded with suspicion an invitation by Houdini to attend the annual meeting of the *Society of American Magicians*. Conan Doyle was fearful that Houdini, and the other magicians attending, would take the opportunity to

ridicule his spiritualistic beliefs. Abruptly, though, Conan Doyle changed his mind, having come up with his own "trick" for the meeting.

The gathering was held at the Hotel McAlpin. Each magician demonstrated his best tricks trying to outdo the others. Finally, at the end of the meeting, Conan Doyle mounted the stage. A movie projector and screen were brought into the room without explanation. Many of the people at the meeting knew of Conan Doyle's beliefs and were aware that he owned a collection of "psychic photographs" (pictures supposedly showing ghosts, fairys, etc.) and may have connected them with Conan Doyle's comments and the motion picture equipment.

Conan Doyle started by telling the audience that he would answer no questions about the movie they were about to see, but said, "These pictures are not occult, but they are psychic because everything that emanates from the human spirit or human brain is psychic. It is not supernatural; nothing is. It is preternatural in the sense that it is not known to our ordinary senses. It is the effect of the joining on the one hand of imagination, and on the other hand of some power of materialization. The imagination, I may say, comes from me-the materializing power from elsewhere."

The lights were then dimmed and the projector started. Suddenly pictures of apparently living dinosaurs appeared on the screen. The members of the audience, including the magicians, were astonished. No one in the room had ever seen anything like this before. The next day the *New York Times* ran a story:

#### **DINOSAURS CAVORT IN FILM FOR DOYLE**

#### ***SPIRITIST MYSTIFIES WORLD-FAMED MAGICIANS WITH PICTURES OF PREHISTORIC BEASTS--KEEPS ORIGIN A SECRET--MONSTERS OF OTHER AGES SHOWN, SOME FIGHTING, SOME AT PLAY, IN THEIR NATIVE JUNGLES***

The reporter from the *Times* didn't know what to make of it and, as he said in his story, couldn't decide if Conan Doyle was "making merry" or "lifting the veil" and using some spiritual means to photograph dinosaurs from the past. The reporter concluded that these "monsters of the ancient world, or of the new world, which he [Conan Doyle] has discovered in the ether, were extraordinarily life-like. If fakes, they were masterpieces."

Needless to say Conan Doyle stole the show that evening. Nobody talked about the magicians performances, only Conan Doyle's film. The next day, after the story appeared on page one, Conan Doyle exposed the trick explaining that the dinosaurs were test footage made by **Willis O'Brien** for the upcoming feature film, based on Conan Doyle's novel, *The Lost World*. O'Brien had lent the reel to Conan Doyle for the trick and at the same time gotten a triumphant test of his work, along with free publicity for the film.

### **LEONORE PIPER (1859-1950)**

Perhaps the greatest American medium ever. One of the most spectacular and outstanding mental mediums who ever lived. No one, not even the most hardened closed minded skeptic after investigating her mediumship ever suggested fraud. She was able to convert the greatest materialist, closed minded skeptic this world has ever seen - Richard Hodgson. Because of her brilliant accurate information, Hodgson, who was contracted to by the British Society for Psychical Research engaged private detectives to follow her, to report on whom she met outside her home, to intercept her mail, to invite negative 'dummy' sitters unknown to anyone to her sittings - and to do everything possible to prove that this highly gifted brilliant American was not genuine. All failed and she remains today the greatest American mental medium who triumphed over great challenges. [more](#)

### **BETTY WHITE (1880?-1939)**

Wife of Stewart Edward White. In 1922 Betty discovered, while using a ouija board, that she was able to communicate with entities which would later be dubbed "the invisibles". They invited a small circle of friends including "Darby and Joan" to participate in sessions during which her channeling abilities matured. Stewart's first book openly acknowledging Betty's contacts was *The Betty Book* (1937), a compilation of the messages his wife received followed shortly thereafter by *Across the Unknown*. These first books resulted in thousands of letters from the readers. The White's were very private people who had kept Betty's abilities under wraps for over a decade. [more](#)

### **STEWART EDWARD WHITE (1873-1946)**

Author who published a number of books of "channeled" material. He studied at the University of Michigan (Ph.D., 1895; M.A., 1903). In 1904 he married [Elizabeth \(Betty\) Grant](#), and they settled in California where he became well known as an author of many books, articles, and short stories dealing with his experiences around the state in mining and lumber camps, and on exploration trips. He wrote *The Betty Book* (1939), *Gaelic Manuscripts*, *The Road I Know* (1942), *The Stars Are Still There* (1946), *The Unobstructed Universe*. (1940) (his most popular metaphysical work) and [With Folded Wings](#) (1947). [more](#)

**ARTHUR FORD (1896-1971)** American Spiritualist medium and founder of the International General Assembly of Spiritualists. Ford realized his psychic abilities during World War I. While in the army he would "hear" the names of people he served with, and those names would appear on the casualty lists several days later. In the years after the war he investigated psychic phenomena and eventually joined the Spiritualists. Around 1921 Ford emerged as a trance medium, and "Fletcher," his control for the rest of his life, made his first appearance in trance sessions. He developed a popular following and in

1927 traveled to Great Britain. One of his lectures was attended by veteran Spiritualist Sir Arthur Conan Doyle, who enthusiastically told people the next day, "One of the most amazing things I have ever seen in 41 years of psychic experience was the demonstration of Arthur Ford." [more](#)

### **FRANCISCO XAVIER (1910-2002)**

Famous Brazilian Spiritist medium. (Spiritism, the Brazilian form of Spiritualism, stems from the teachings of French Spiritist Allan Kardec). Known throughout Brazil as "Chico Xavier" (pronounced Sheeko Shaveer), he was born April 2, 1910, in the town of Pedro Leopoldo in the central state of Minas Gerais. He was one of a family of nine children. His mother died when he was only five, but Chico saw her materialize after her death, and during his period at primary school three years later, he became accustomed to hearing voices and sensing spirit presences. [more](#)

## *Twitter*

Twitter character scripts

### **Jimmy**

I think “Big Foot” looks like a photobomber in a hoodie. What do you say, paranormal optimists? <http://bit.ly/mGkjuf>

Ugh. The Chinese place always dumps sugar in my coffee. I keep telling them I like it black.

@Austin Are you coming to the McCauley family dinner tonight? Mom is making ham and rolls!

Adding up our receipts is giving me stomach pains. Paranormal investigation is not cheap.

Glad our fans are smart enough to tell the difference! RT @Darnell Our competitor show on A&E cracks me up. They’re so fake it’s unreal.

Woke up at 5am this morning to watch Yo Gabba Gabba with my kids. Splitting headache now.

### **Tab**

I say Big Foot isn’t paranormal! :P RT @Jimmy I think “Big Foot” looks like a photobomber in a hoodie. What do you say, paranormal optimists? <http://bit.ly/mGkjuf>  
Met a psychologist who is haunted by the ghost of a suicidal patient. It would probably be insensitive to say that’s awesome, right?

Who replaced my scientific equipment with Ghostbusters toys?

I bought an old typewriter during my mountain getaway. I was hoping it would be haunted but no such luck.

Researching post-civil war slavery in prep for taping a new episode.

### **Darnell**

I know Kia Soul are sponsors of the show, but it would be great to have a car that could get up the driveway when it snows.

Our competitor show on A&E always cracks me up. They’re so fake it’s unreal.

Do you figure Cap’n Crunch ever killed anyone in the Navy?

Watch the show this Friday@10 to see of the craziest ladies we’ve ever had on the show.

### **Noreen**

Somehow @Austin got Oreo cookie crap inside my running shoes. I don’t even want to know.

After filming this week’s new episode of The Ghost Club I slept with a night light for weeks. Find out why Friday@10.

Very good expose about Atlanta’s dog fighting ring in today’s AJC. #scariertanghosts  
Visiting my alma mater today to talk about how I used my lit major to become a ghost hunter.

No. He blew up some ships but the people just got all soggy. RT @Darnell Do you figure Cap’n Crunch ever killed anyone in the Navy?

### **Caitlin**

I bet you do, tiger! RT @Jimmy I'm mad. The Chinese food place always dumps sugar in my coffee. I keep telling them I like it black.

Pass! I still have fleas from the last time! RT @Austin Who's up for going to Elmyr's this weekend? <http://www.elmyr.com/>

Someone in the Ghost Club isn't who they say they are. That's all I've got to say about that.

Something tells me the Republicans won't get it together by 2012. #psychicvisions #notreally #lol

Ghost Club peeps! New episode Friday@10pm! You don't want to miss me, do you?

### **Austin**

How did you know it was me? RT @Noreen Somehow @Shane got Oreo cookie crap inside my running shoes. I don't even want to know.

I just realized that Manfred Mann must have been hung over when he wrote "Blinded by the Light". #epiphanies

Who's up for going to Elmyr's this weekend? <http://www.elmyr.com/>

Beer, cigarettes and staying healthy at the gym. #favoritethings

Sorry, I've got plans with @Sk8terGrl. RT @Austin Are you coming to the McCauley family dinner tonight? Mom is making ham and rolls!

A girl I met on the bus says she saw hipster ghosts dancing in Little 5 Points. She was going to show me but she snores so nevermind.



## ***Flash Game***

### **Vision statement**

#### **The Ghost Club Flash Game**

##### Product Vision Statement

### ***Motivation/Opportunity***

We are building this product as a piece of a storyscape related to *The Ghost Club*. *The Ghost Club* franchise spans multiple media artifacts, and our task is to build the interactive Flash game facet of the storyscape. The goal of constructing the storyscape is to further our client's research in the field of transmedia storytelling.

### ***Problem Statement***

The problem of	ineffective transmedia storytelling caused by a lack of diverse media artifacts
affects	media creators and their audiences
the impact of which is	weak franchises and disappointed audiences
a successful solution would be	more diverse media artifacts to support a richer storyscape

### ***Product Position Statement***

For	people who are partial to settings similar to that of our storyscape
Who	enjoy playing flash games
Our System	is a flash game built for any platform with strong Flash support
That	enables users to play our game and experience part of The Ghost Club's storyscape.
Unlike	countless other non-transmedia flash games
Our Product	draws the player into a larger storyscape while also entertaining the player.

### ***User Demographics***

The users that the Ghost Club game targets people partial to settings similar to that of our storyscape. This demographic includes two key audiences - existing fans, and non-fans (whether they are familiar with The Ghost Club or not). Existing fans may be emotionally and intellectually invested in The Ghost Club's mythology and universe, so for this demographic, it is more important that a game placed in the franchise's setting avoid violating its canon and mythology. On the other hand, non-fans lack this investment, so as entertainment software, the primary expectation is that our software provides entertainment. Hopefully the entertainment value of the game, combined with its presentation of part of The Ghost Club's storyscape, will be able to appease existing fans while introducing (and hopefully making new fans of) non-fans. Gameplay accessibility is also an important requirement for both fans and non-fans alike, since inaccessible game controls frustrate and drive away inexperienced players.

### ***Feature List***

See Pivotal Tracker.

### ***Constraints***

- Must use Adobe Flash
- Must not violate The Ghost Club's cannon
- Must not contain inappropriate or offensive content
- Must use accessible controls

### ***User Stories***

See Pivotal Tracker.

## *The Ghost Club TV Show Bible*

### **I'm not sure if we are doing treatment or show Bible**

The Ghost Club--a scientific but secretive team of paranormal investigators founded in the 18th century--has always been investigating ghosts and other super normal events. Their mission--to seek out, and figure out, and sometimes conceal the strange happenings that leak into the world of the living. Teams are dispatched around the world to investigate and authenticate these ghostly events. The teams have to respond to the TGC board's directives - and they seem to believe that mankind is not ready for some of the mind-bending realities they confront.

Today they hide their activities in plain site. In the 21st century, The Ghost Club is a popular reality TV show where skilled ghost hunters run investigations, collect data, and are in a constant search for proof of the existence of ghosts. *(Making their main goal to falsify and obscure evidence is weird and complicated and gives the whole game away - that is essentially Men in Black not ghosts I think. I think we finesse and roll out the info like Lost or X Files.)*

Each episode of the show is secretly a club investigation of a suspected haunting, possession, or visitation that the Club must crack. The modern Club is a team of highly educated and trained skeptics and believers, who must not only be experts in paranormal investigation and elimination, but telegenic performers as well.

The Club is not sure what these ghosts are, spirits in search of a re portal to the next world, echoes of past lives, or is this some form of bleed through from another parallel universe? Some investigations and tools are not for the public and on occasion evidence has been put aside for, ahem, "further authentication" by the commission.

But with dangerous paranormal activity on an exponential rise, and with no known cause, will the Club be able to continue its mission, and maintain its ruse? Or will the things that go bump in the night finally have their day?

## ***AUGMENTED REALITY GAMES AND STORY***

### **Product Vision Statement**

Why are you building this product?

In keeping with the client's wishes for a product that will ultimately combine all aspects of storytelling we will be creating additions/modules to an AR video game. This game will focus on user experience and connecting users back to the world of The Ghost Club.

Why not something else?

There are other games that fulfill some of the needs but none that fulfill all of our needs. The game being designed must complete The Ghost Club(TGC) experience. To this end, the game must tie in to the lore and world of TGC.

What is special about your product?

The first is that this game will tie into TGC experience. The game will also have a specialized Ghost Punk style/theme. Finally the game will also utilize Augmented Reality and associated features.

Problem Statement

The problem of

A need for a game as a part of a transmedia experience

affects

The Ghost Club

The impact of which is

Without a game TGC experience is not complete and users have no other way of interacting with TGC

A successful solution would be

A completed interactive AR game for the android platform that allows users to experience TGC world as the characters do

Product Position Statement

For

Anybody who has an android device

Who

Playing the game

Our System

All SW

That

Enables users to place and find ghost while interacting with friends or go on a ghost hunting tour

Unlike

Other products that just detect or find ghost with an individual experience

Our Product

Is a group experience that allows players to place and find ghost.

Users:

End Users: The end user is interested in hunting ghost and has an android device. They want to go out with a couple of friends and enjoy the thrilling experience of searching for ghost. They are also competitive and want to get as high a score as possible. The end user will have enough previous experience to functionally operate their android device.

Feature List: See Pivotal Tracker List

Constraints: Time, Hardware is limited to android enable devices, product must use private-source code from Haunted Planet Studios, there is no budgeted money so all assets must already be owned or open source.

## User Stories / Use Cases

### User Stories:

As an end user, I want a team creation screen to participate with friends in the Ghost Club story scape.

As an end user (hunter), I want to take a picture of/with a ghost for social networking.

As an end user (summoner), I want to place a ghost for people to find.

As an end user (summoner), I want to create/customize a ghost.

As an end user (hunter), I want to enter into the narrative tour in order to experience the Ghost Club story scape.

As an end user, I want to be able to choose hunter or summoner for a unique experience.

As an end user (hunter or summoner), I want to be able to choose from a set of classes for a unique experience.

### Use Cases:

End user wants to Summon/Place a ghost:

1. End user starts the app.
2. The front menu comes up.
3. End user chooses "summoner."
4. Ghost creation screen comes up.
  - 4.1. ALT user can choose to go to previous screen and summoning ghost is canceled.
5. End user creates ghost with available options.
6. End user pushes the "place" button.
7. Map comes on screen.
8. User places marker where ghost will be summoned.
  - 8.1. ALT the user tries to summon a ghost outside of the limited area and summon fails.
9. End user pushes "summon" button.
10. Animation/music plays.
11. User is brought back to ghost creation screen.

## Architecture

For this project we will be building upon preexisting software made by Haunted Planet Studios. This software will form the basis of our project. It will inevitably contain it's own software architecture design. However, we have not been provided the opportunity to evaluate this software. So the current software architecture upon which we will be building is unknown to us. However, we have been able to fill in some gaps.

For our part in this project we will be building an android-based application. With this in mind an architectural style similar to Model, View, Controller is sufficient. The three separations for an app are actually a bit too tedious for the intended scope of this project and as such we feel an architectural style of front-end, back-end is most appropriate. The front end will provide the user with a Graphic Interface while the back end will take care of all method calls. It is important to note that because we are still unsure as to the architectural style of the main program we are equally unsure as to whether or not we will be able to use this model for additions.

In terms of data management, it is an intended function of our project that if possible, based on the core program, users will be able to compete against each other. If this function comes to fruition the need for management of persistent data may come into play. Without the base software we are unable to determine what structure we may need for this or if it is even possible.

The software we will be developing will eventually be released to the public. As such the Graphical User Interface we design must be user friendly. Our design goal is to have a fully functional prototype of the GUI up and running. To this end, we have some mock-ups which explain the general feel of what we would like the user interface to look like.

The last portion of this document is dedicated to validation of the software being developed. It is our intent to demo the program to an audience at some point. In the interim we will use a black box testing method which by definition will test the functionality of our program. Arguably, full functionality of features in light of an eventual public demo is an important core aspect of this project.

*ARGON VERSION IPHONE AUGMENTE REALITY GAMESTORY*

**Design graphic - Slider**





*Augmented Reality - Button*



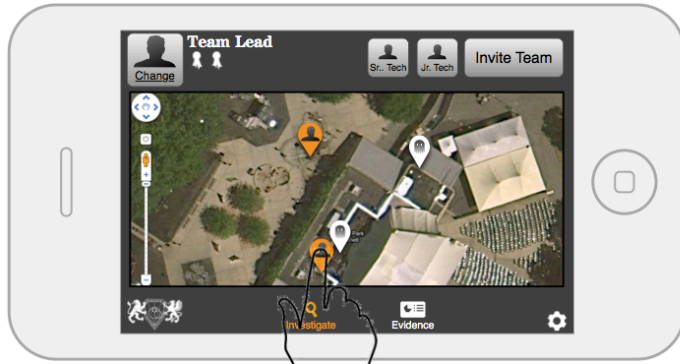

Notes: Additional Views  
1 Note

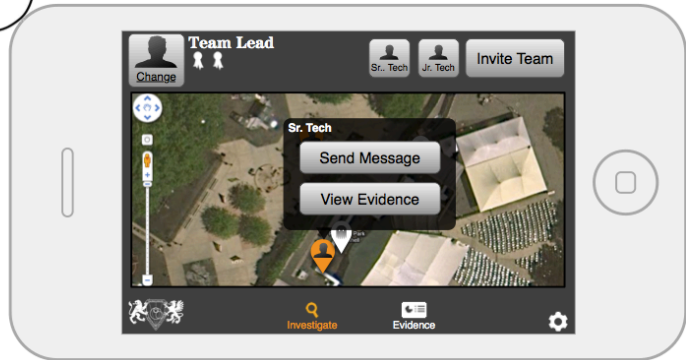

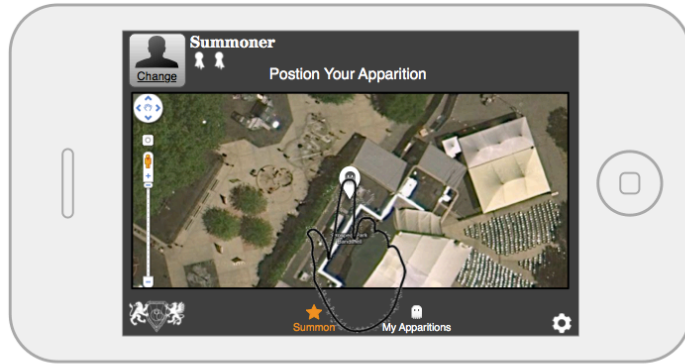

Notes: Additional Views  
1 Note

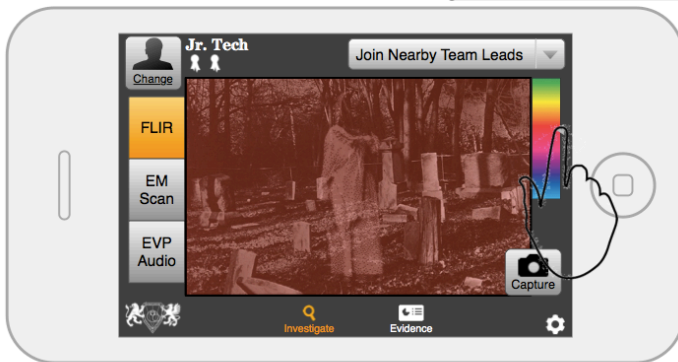
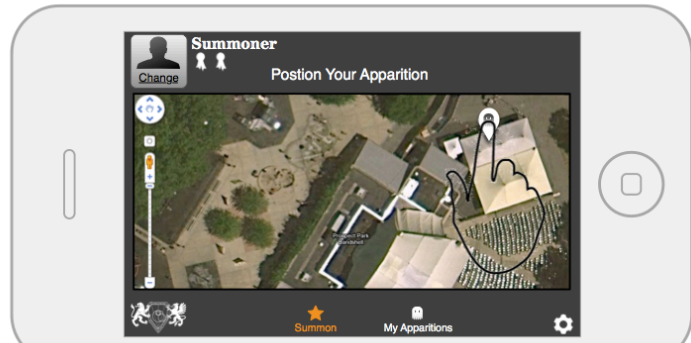

Notes:  
1 Note

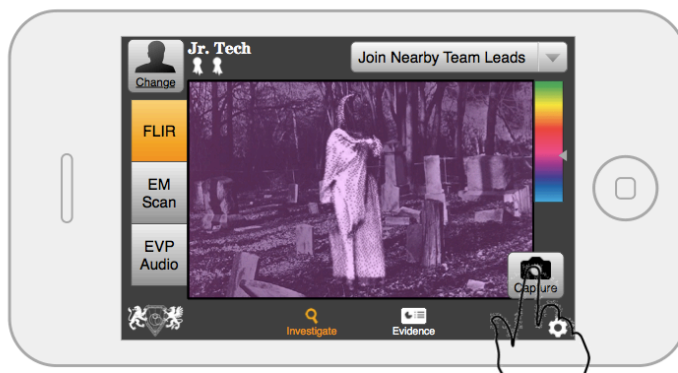

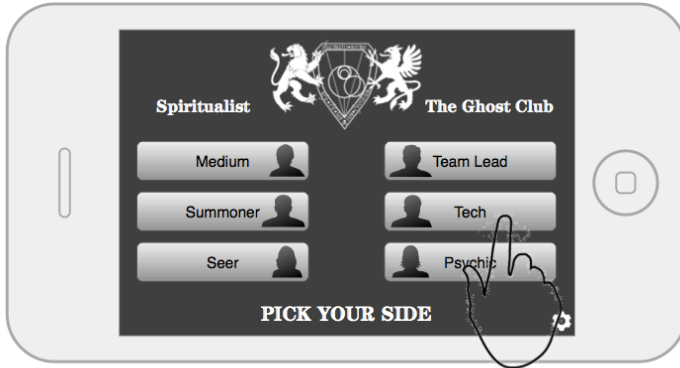

Notes:  
1 Note

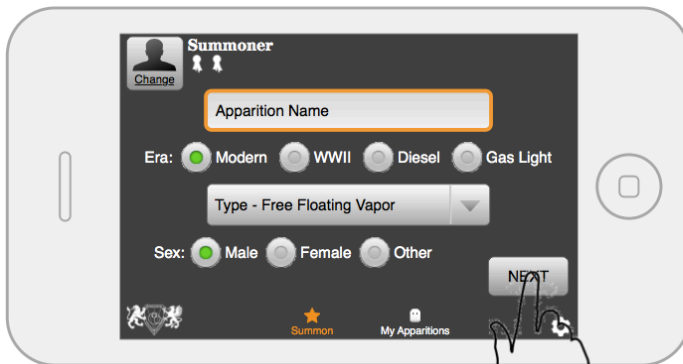

Notes: Additional Views  
1 Note

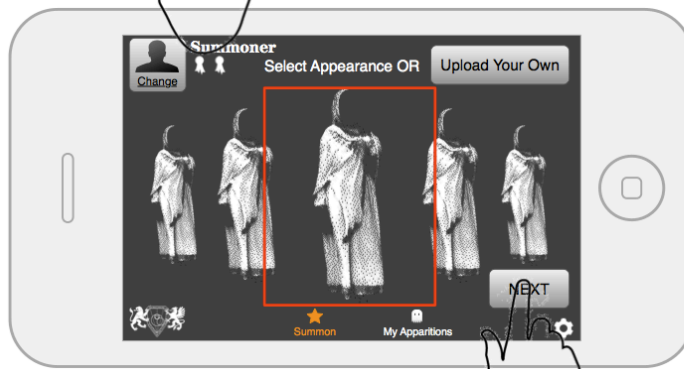



Notes:  
1 Note



Notes:  
1 Note



## **TGC GAMES AND APPS**

### **iPhone Game (augmented reality app)**

The Ghost Club iPhone Game (ARG app)

#### 1. Ghost vs. Club (Ghost Explorers)

Club members (users) will use a “ghost finder” app to find ghosts that exist in the ARG hidden world. Another layer would be if users could control ghosts to compete with the explorers.

App would also include EMF meters (fake) and other ghost hunting tools. Use of photographs as way to reveal or capture ghost

#### 2. Wilkinson House Ghost Game

Users will explore a shared ARG space that involves a series of narrative developments while hunting ghosts and revealing the space.

#### 3. Ghost Mystery Game

Hunt the ghost

People have different skills or devices (technician, psychic, leader, jr. investigator)

#### 4. Poster Games

Being able to explore 3d models to discover ghosts in the house. Different models have different info. Images could be captured and shared.

### **Add documentation**

Ideas from the demo day:

- human body as sacred object; the virtual objects becomes meaningful when attached to human rather than space.
- how to retain long term interest? Ownership of space and virtual objects in the space
- Alternate Reality games – how to introduce the mystery

### **Section 1: Relevant apps to our game design**

1. Papa Sangre – voice only video game from Somethin else. The game uses binaural sounds to guide you, and the mission is to get through each level without being caught by a monster. You play the game using touchscreen controls though (which let you control your path, and the rest of the screen is blank). This is their official site: <http://www.papasangre.com/>, and these are some reviews: <http://www.youtube.com/watch?v=lbt8JPqziHw>, <http://www.148apps.com/reviews/papa-sangre-review/>
  - a. How this is relevant – currently we can add binaural sounds in Argon, but there is no easy way to change the sound based on where the user is standing – and this would be quite computationally hard in any case.
  - b. Check this out for examples of binaural sound: <http://www.youtube.com/watch?v=IUDTlvagiJA>. I have added this to a simple Argon channel at [www.graffitos.org/harry/virtualhaircut.kml](http://www.graffitos.org/harry/virtualhaircut.kml) You



can load this in Argon to listen to how binaural recordings sound in Argon.

- c. If we do have the necessary equipment to create such sound pieces, it would be an awesome effect – we'd have to figure out what hacks to use in order to make it convincing when the user is moving though.
2. Augmented reality ghost hunter: <http://arghgame.com/> - Something similar to what we want to do. Ghosts exist in the world at certain physical locations, or at specific times of the day. Lets you capture ghosts when you see them, and post to facebook/twitter. It also includes a proximity sensor of some sort and voice output (the ghosts sometimes make noises if you are close enough)
3. Ghostbastards: Hunt ghosts in virtual or real environments. Seems simpler and less fun than the ghost hunter. <http://itunes.apple.com/us/app/ghost-bastards-ar/id375374771?mt=8>, <http://avaloid.com/ghost-bastards-ar/iphone>

### **Section 2: Generic links about augmented reality apps and reviews:**

1. <http://www.mobileaugmentedreality.info/>
2. <http://www.iphoneness.com/iphone-apps/best-augmented-reality-iphone-applications/>
3. <http://www.brighthub.com/mobile/google-android/articles/97399.aspx>
4. [http://www.youtube.com/watch?feature=player\\_embedded&v=6NKT6eUGJDE](http://www.youtube.com/watch?feature=player_embedded&v=6NKT6eUGJDE)
5. [http://www.youtube.com/watch?feature=player\\_embedded&v=6NKT6eUGJDE](http://www.youtube.com/watch?feature=player_embedded&v=6NKT6eUGJDE)

### **Section 3: Games:**

1. AR basketball: Print the marker from their site and a hoop appears wherever you place the marker. <http://itunes.apple.com/us/app/arbasketball/id393333529?mt=8#>
2. Firepower: Burn someone you don't like!  
<http://itunes.apple.com/us/app/firepower/id317465162?mt=8>
3. Sky siege: Completely immersive gameplay, love the way the game makes you move about and frantically look in every direction. (According to reviews).  
<http://itunes.apple.com/us/app/sky-siege/id349892759?mt=8#>
4. AR Quake: Not mobile AR, uses HMD.  
<http://wearables.unisa.edu.au/projects/arquake/>
5. GeoChaser: Lets you chase your friends in the real world, show you their locations. <http://itunes.apple.com/us/app/geochaser/id335595221?mt=8&ign-mpt=uo%3D6>
6. AR scavenger hunt for android: <http://www.androidpit.com/en/android/forum/thread/405681/Scavenger-Hunt-in-Augmented-Reality>
7. Microsoft AR treasure hunt using bubbles:  
<http://arnewsroom.com/arnews/microsoft-augmented-reality-treasure-hunt-and-core-tool-augmented-reality-ar-platform-0093.ht>

### **Section 4: Application specific simple augmented reality apps:**

1. Lets you visualize furniture in your living room: (For the iPhone, free) - Interesting app, not sure why there aren't loads more like these. Uses just 2d images though (Not 3d models) <http://itunes.apple.com/us/app/snapshop-showroom/id373144101?mt=8>
2. New York subway info: More of geolocation based info than AR, but such niche applications I guess are more useful than the generically putting too much info into the world at a time. <http://itunes.apple.com/us/app/new-york-nearest-subway/id323100520?mt=8>
3. Peaks: Again a very specific app that tells you names of the mountain peaks visible, and their info. Simple but useful. Would love to see someone do this for all buildings in a big city, from different vantage points! <http://itunes.apple.com/us/app/peaks/id332170121?mt=8>
4. Star chart: Similar concept, but for stars. Interesting but nothing beats a planetarium experience! There are similar such apps for astronomy, sun position, etc. <http://itunes.apple.com/us/app/star-chart/id345542655?mt=8>
5. An app to find where you parked your car! Not sure how useful it is, but it's better than opening a map to figure out where your car was parked :P (Would love to try it out) <http://itunes.apple.com/us/app/find-your-car-ar-augmented/id370836023?mt=8>
6. Real typing: Incredibly simple but useful app! I find myself wishing everyday there was something similar for all the applications in the iPhone, just so I don't bump into things when I'm, say, reading a mail while walking! <http://itunes.apple.com/us/app/real-typing-augmented-reality/id344994109?mt=8&ign-mpt=uo%3D6>
7. TagDis: Add graffiti in the world. I am not sure how exactly it works (how you select which surface to paint on), but it's an interesting application nonetheless. <http://itunes.apple.com/us/app/tagdis/id372622939?mt=8#>

### **Social experience in and around Ghost vs. Club iPhone app**

This doc talks about my vision of the social experience involved in the play. I want to tease out the "essential experience" for a player. Is it the surprise when seeing the ghost? Or the collaboration among other players? Or the here-and-now interaction with a co-located peer who may have a separate account or not? Or online interaction with remote players? Or mapping the movie/webisode experience to real life (e.g., mystery solving, adventure, friendship)? Or the emotion that are consistently being provoked by different media? These are all valid and appealing aspects of experience that would be created with our system. I talk about my personal preferences and reasons in this doc, but you may have different vision, and this document is a starting point for such kind of experience.

#### **1. Who might be involved in the whole experience?**

Friends, spouse, family, facebook friends - facebook friends seems to encompass many of the other social relationships we have. More importantly, it is an EXPLICIT form of relationship than we had before.

It looks like what we plan to focus on is facebook friends. but *who are these people that we call as a "friend" on facebook?* They are a highly diverse combination, obviously.



Google researcher Paul Adams researched the composition of facebook friends, and found that an average user have 2-6 categories depending on how they met.

*What kind of things we do with our Facebook friends?* in short, not much. What prior research found is that, although we have hundreds of friends, those who we actually interact with is very small, and those who we repeatedly and regularly interact with is extremely small [].

In the meanwhile, it is interesting to notice that a high percentage of interaction comes from a very small fraction of Facebook friends.

*What's the meaning of so-called weak link (some people call them "thin link") these days?* Researchers from 30 years ago found that when we are doing things like job hunting, weak links are actually more useful than strong links. Also, these relationships are not static, playing games can change the relationships, and of course who you play with is decisive to whether and how you enjoy the game.

*How are these related to our app?* First of all, it will benefit us to take a look at successful and not so successful facebook games and apps and figure out why. Second, we also want to pay special attention to location-based Facebook apps. Third, how do we leverage the existing social network in Facebook for the gameplay and marketing?

## **2. Different layers of involvement**

*2.1 Direct involvement:* This person sits next to you when driving toward the location where ghosts are. He/she looks over your shoulder and check your iPhone together when walking in the cemetery at 11pm. Actually, besides playing with our app, you do a lot of things with them, they might share the same apartment with you, you do grocery shopping together, you go to concerts together etc. So you might as well hunt the ghost side-by-side along the way going to these places. One thing for sure is that, you two (or three) have done more than one stupid things together before. If this friend of yours happen to have an iPhone (which is likely to happen since people's purchase behavior was highly influenced by close peers), you two might take roles that can cover each other's back. I think this layer as a very important reason for the stickiness of the app.

*2.2 Remote interaction with acquaintances:* This layer is a bit distant, but still fun to interact with. This might be your long-lost-but-recently-recovered high school body or your cousin in a different city. The point is, you don't really share much of your life with now at current stage. You talk about things on Facebook or IM once in a while, but you haven't done anything together for a long time although you had a history. They might drop a ghost on your driveway, which reminded you that you once scared the crap out of them when you were ten. They might trade some cool gadgets with you just because that would pop up an equally cool msg on their Facebook status update. This layer is also important since you can trust who these people are in real life, which is an important foundation for developing relationship online.

*2.3 People who share similar location as you, but you don't really know them:* They might be the people who are interested in local meetup events already. They might be the

neighbor that the only occasion that we talk to is when we are stuck in the elevator. They might be your friends' friend that you don't really know but are suggested by Facebook. Anyway, you don't really know them until you play in the game together. Are there security and privacy issue that we want to deal with here? Probably yes. How are these players that I might not interact direct affect my own experience? The fact of sharing the space would at least give you some fun of parallel play.

**3. Other questions:**

- What are the core social groups that we design for?
- What are the potential emergent social behaviors?

## ***Flash Games***

Ghost Vs. Club

Architecture and Rationale:

Out of all of the architecture styles that we have looked at, event-driven seemed to stand out the most. In the event-driven architecture the focus is on responding to events that can come from either the user or from the system itself. It is immediately clear why this would fit a video game quite well. The user interacts with our system by creating events through mouse clicks and key presses, and the point of the system is to respond to the user and update the game. There are also events that are occurring within the game. When our AI controlled ghost club members accomplish certain tasks events will be triggered. By using an event-driven architecture our approach will be to respond to the events that are happening which seems to be the best way to approach things.

The only other architecture that seemed to have possibility was the shared memory architecture. In this setup the focus is on a shared set of memory. In this method, we could have all of our classes be reading and posting to this shared memory, along with user interactions committing information and being constrained by the shared memory. We decided not to go with this particular architecture because we felt like it was more suited for more complex AI or problem solving, and less efficient for something like a video game.

We also had to make some decisions about what development environment, language, and tools we used. Our client expressed interest in having the product written in Flash so we decided to go that way. We did discuss using HTML5 or Facebook to create the game but we decided that Flash would be better due to its wide use for this type of project and portability. We were going to use Adobe Flash CS5 for development because of its clear power in making this type of project. It not only had the scripting built in, but also had drawing utilities to create the visuals for the game. In the end though, we decided instead to code in FlashDevelop. We did this for multiple reasons. First off, FlashDevelop is open source and therefore free. This allowed our entire group to easily have access to the IDE. Secondly, we were aiming to use an additional coding tool to help with the game creation such as Flixel or FlashPunk. It turns out that because these tools are open source, they only support integrating with other open source products. This means that we could not use these tools in Adobe Flash CS5, but only in FlashDevelop, which was the final reason we decided to go with FlashDevelop. The last choice we made was between Flixel and FlashPunk. Jeff did some research and decided that Flixel was more highly applicable to our goals and would be the easiest to quickly adapt to our uses for the game.

### **Data Design:**

The only persistent data that will be associated with our program will be user save files. To implement this feature we will be using Flixel's built in save features. This will allow users to save their game, which will store one small file on their computer. There will be no other persistent data or databases.

### **Detailed Design:**

Figure 1 shows the general file layout for the scripts that make up our game currently. The first file to be run when the game is loaded up. This script sets the screen size and resolution. It then calls the PlayState.as file. PlayState.as is currently our only play state, when is an object in the Flixel development environment which represents a particular state during the game. PlayState.as is the main script that is run threw repeatedly as the game is being run. During its loops it makes calls to GhostHunter.as, IsoMap.as, and Menu.as. GhostHunter.as is the script responsible for drawing and controlling the NPC characters that are the ghost hunters. This script deals with their AI that controls how they move around the screen, collide with walls, and respond to other events. GhostHunter.as uses IsoObject.as to store the characters as IsoObjects which is another object type in Flixel. IsoMap.as is the script that deals with the map. It has the hard-coded values for where the ground tiles should be, along with where the various walls are. It calls Wall.as to create the walls on the map. This is also the file that will contain the various other objects such as furniture on the map. Menu.as is the script that controls the menu features. It calls Action.as to create new actions that are representations of abilities the user will be able to use. It then displays these actions on the screen.

Figure 2 shows the class diagram for our project. This figure shows each of the files with their variables and functions. There are no typical associations between any of these classes.

Figure 3 shows the sequence diagram of how the scripts interact at run time.

### **Graphical User Interface:**

Figure 4 is a very early mockup of what we thought our game might look like. This screen shows a score counter in the top left, menu of abilities on the far left, and the main display in the middle.

Figure 5 is a more update prototype of what the game is going to look like. This is a screen shot from our current functionality with moving characters and a very basic menu.

Figure 6 is a compilation of our beginning work on the furniture objects that will be in the various rooms.

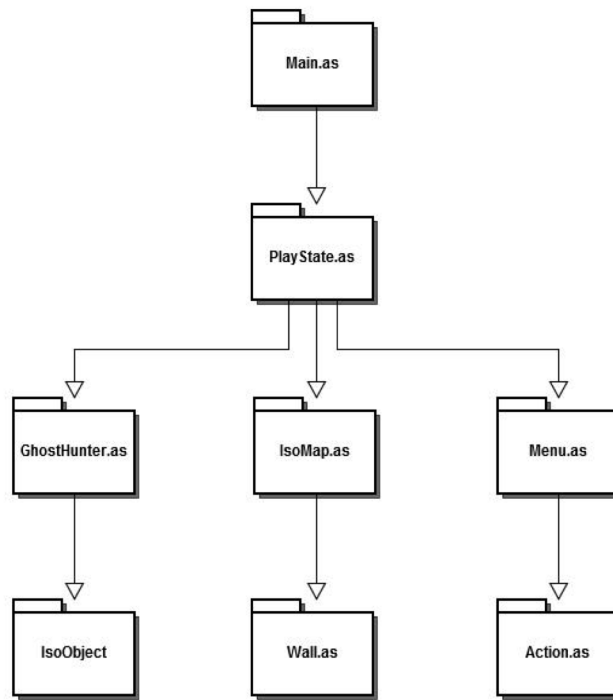

Fig 1.

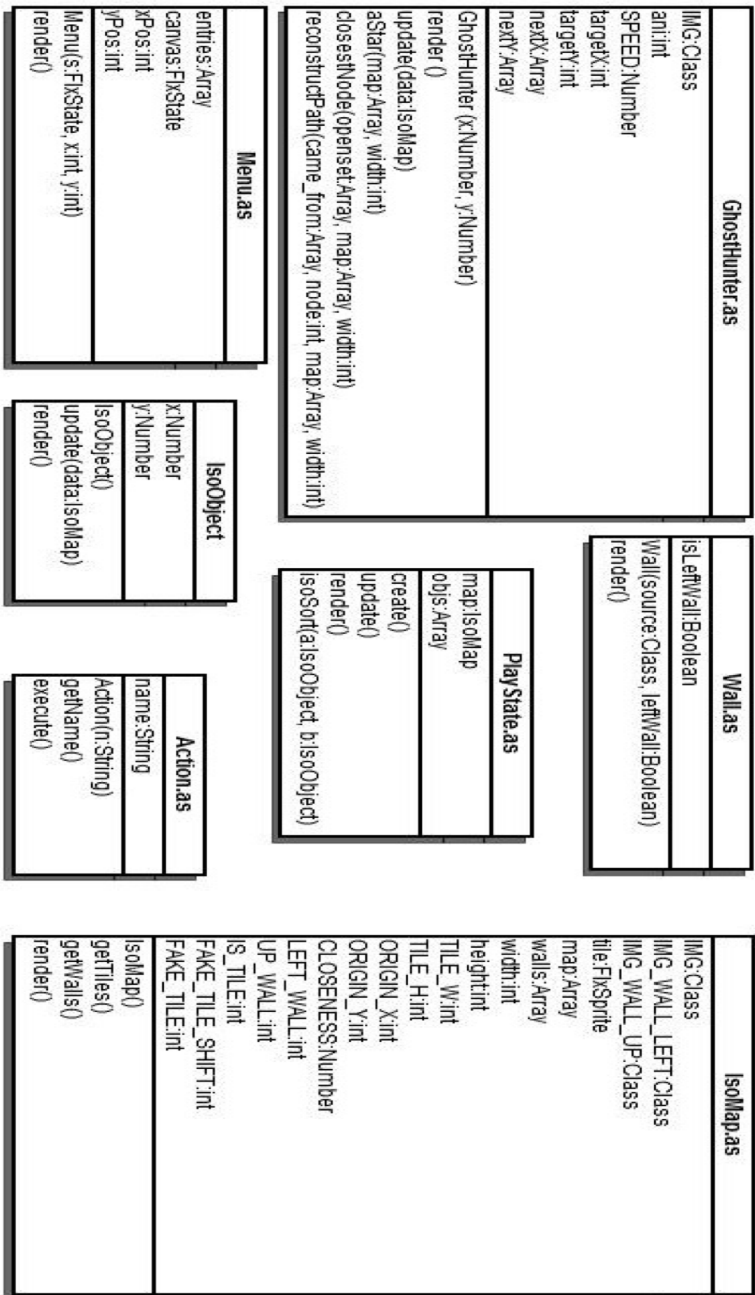
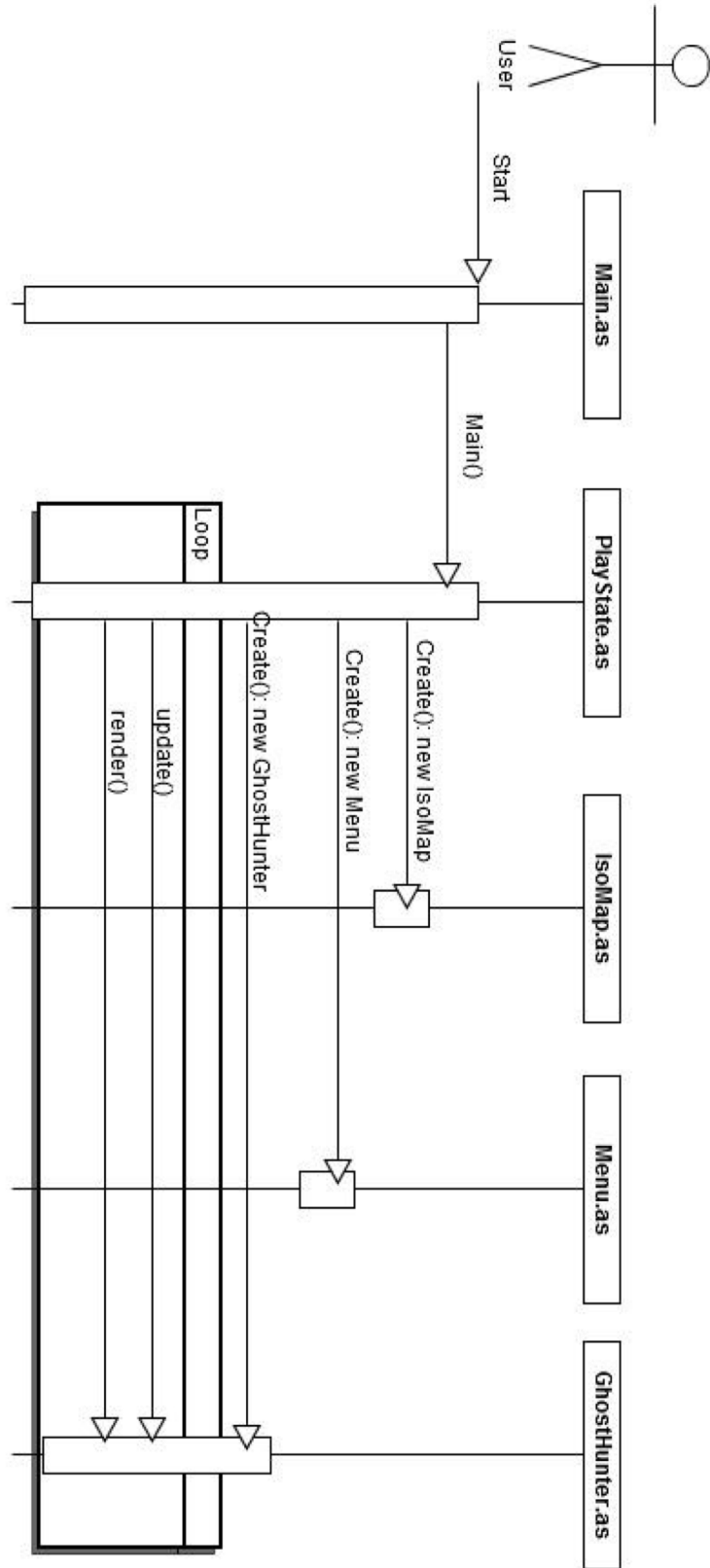

Fig 2.



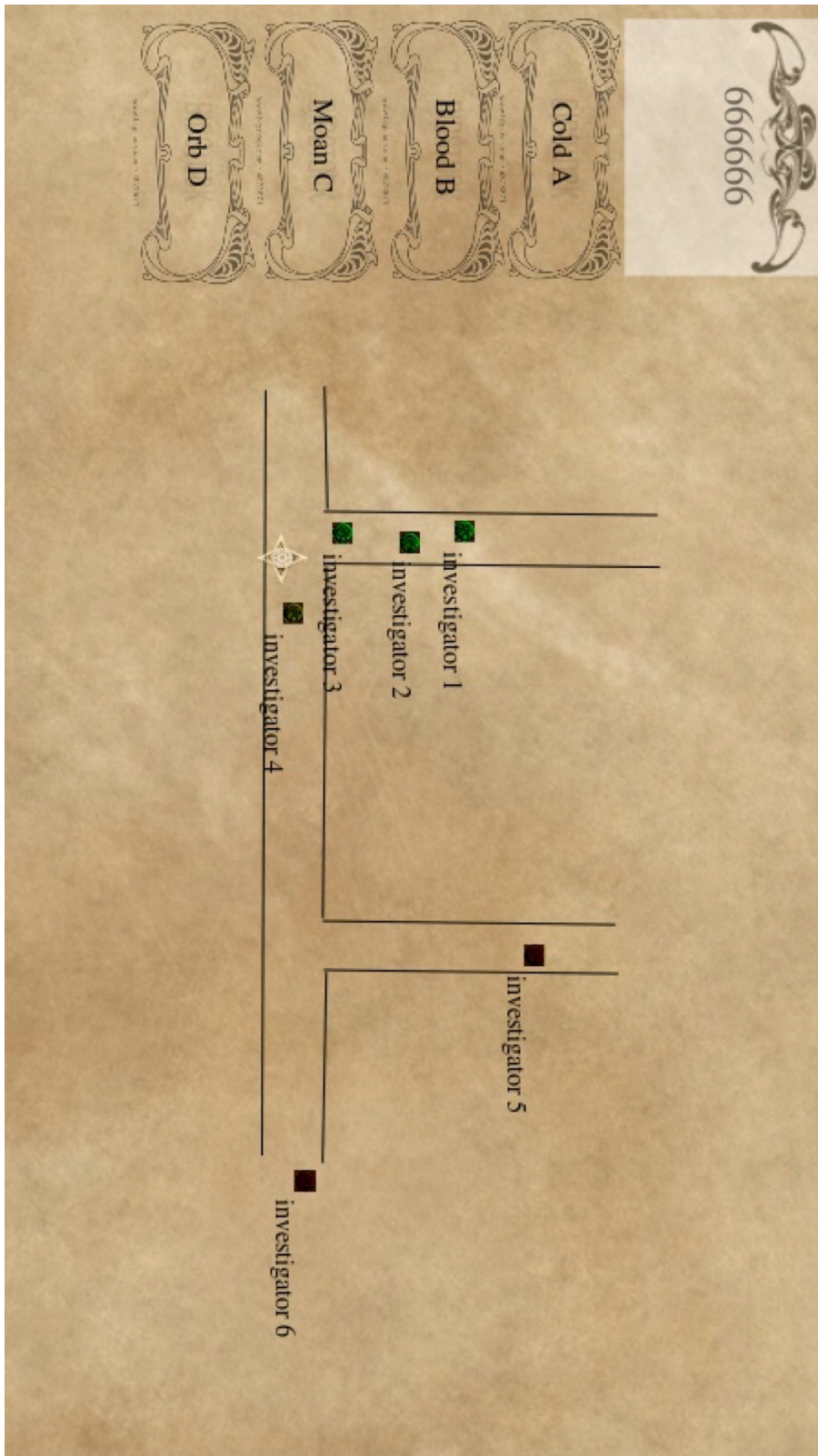

Fig 4.



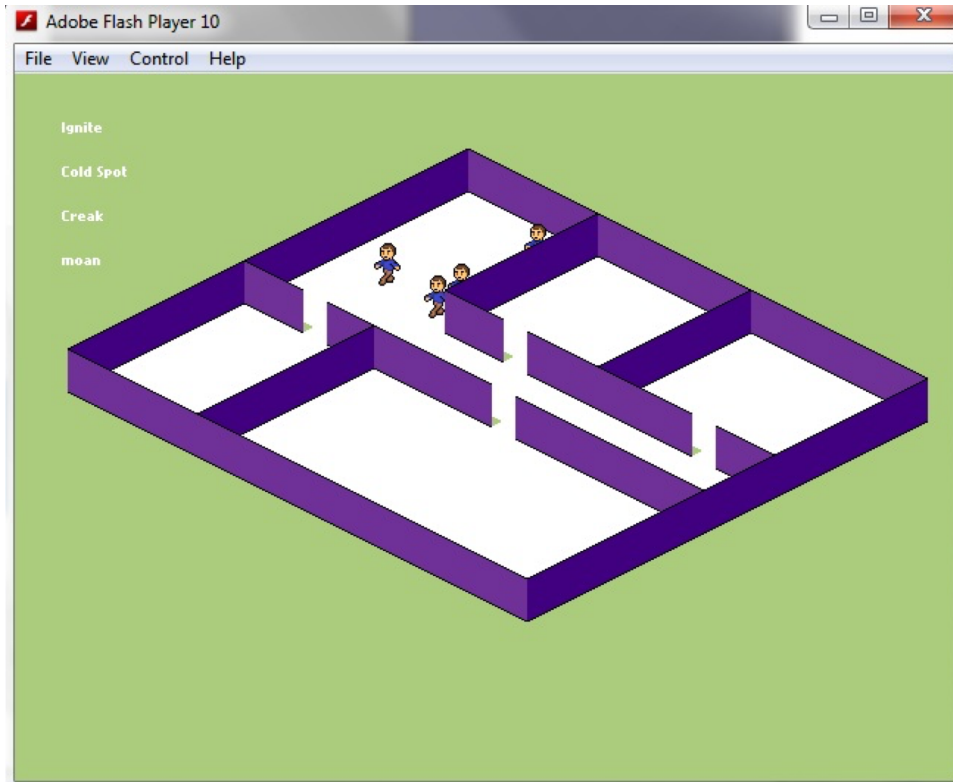
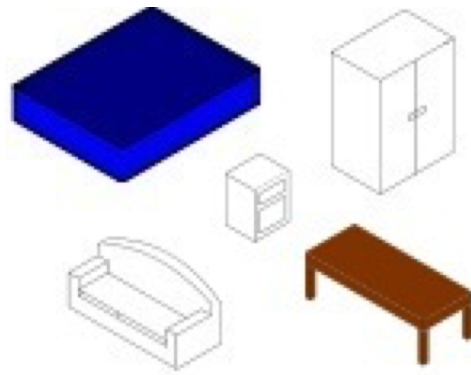

Fig 5.



**Fig 6.**

## **The Ghost Club Flash Game Delivery Documentation**

Current version information, status, known bugs

Installation Instructions

User Manual

Additional Included documents

Included Source Code

### 1. Current version information, status, known bugs

The current version of the Ghost Flash Game which has been delivered to you includes the following functionality: ghost club members and included AI, three abilities including hot spot, cold spot, and orb, hidden notes, ghost death machine parts, win and lose detection, and a map with two hidden notes and three hidden ghost detection pieces. There is also an included map editor for making new maps, which will require some technical knowledge. There are no none bugs currently.

### 2. Installation Instructions

If you would like to make modifications or additions to the project you must do a few things. You will need to use the development tools that we did, which are free and available online. This first product you will need is FlashDevelop located at ([http://www.flashdevelop.org/wikidocs/index.php?title=Main\\_Page](http://www.flashdevelop.org/wikidocs/index.php?title=Main_Page)). The second product you will need is Flixel located at (<http://flixel.org/>). The following link contains a simple and easy to follow tutorial about installing and setting up Flash Develop ([http://flashgamedojo.com/wiki/index.php?title=Installing\\_FlashDevelop](http://flashgamedojo.com/wiki/index.php?title=Installing_FlashDevelop)). The next link contains a simple tutorial for setting up Flixel to be used in FlashDevelop, along with the basics of how the products work together ([http://flashgamedojo.com/wiki/index.php?title=Hello\\_World\\_-\\_FlashDevelop%28Flixel%29](http://flashgamedojo.com/wiki/index.php?title=Hello_World_-_FlashDevelop%28Flixel%29)).

## User Manual

Distributing the actual flash game is simple. Uploading the GhostClub.swf file to any website and linking to it will allow for the game to be played. This file can also be embedded in a webpage. To distribute a modified or newer version refer to instructions below on editing and releasing new versions.

To make any additions or changes to the game you will want to open the Ghost Club FlashDevelop project in FlashDevelop. This will open all of the code and image files used for the game, and allow you to make any additions/changes desired. To publish a new version, change the drop down box from Debug to Release, run the

program, and you will have a new GhostClub.swf file in the /bin folder of your GhostClub folder. This file can be distributed through the same methods as the original .swf file.

We have also included the ability to make new maps for the game. Open the GhostClub project in FlashDevelop and open the PlayState.as file. Changing the line of code on line 26 from false to true, will cause the game to load the map editor when started instead of the normal game. The awsd keys can be used to move the map around. The arrow keys can be used to move the active cursor around. RT keys can be used to rotate through objects. The Enter key places objects on the map. The space key outputs the integer array that represents the map. Putting this array in the Map.txt file will change the game to use the new map instead of the old one. Reset the line 26 of PlayState.as to true to start back the original functionality of playing the game.

#### 4. Additional Included Documents

##### ArchitectureDesignRationale.doc

This document discusses the architecture that was used to develop the game. In this document we discuss the various other architectures that we examined, and our reasons for choosing the one we did. We also discuss our decisions to use FlashDevelop and Flixel. We also examine some of the early GUI prototypes with some explanations of more recent ones. Lastly, we look at what plan we used to validate our design decisions.

##### ProductVision.doc

This document contains our vision for what our product would become. We discuss the motivation and opportunity that this game was supposed to fill. We discuss what previous designs did wrong and how we planned to improve upon them. We looked into the demographics of our target users. This document also contains a list of features for the game, constraints, and user use cases. All of these were used for planning, development, and for quality assurance. The last part of the document contains some initial brainstorming of game designs we looked into at the beginning of the project.

#### TestPlanDocument.doc

This document examines the processes and requirements that we put our project through during the quality assurance phase of development. It discusses our testing strategy, adequacy criterion, and a list of all of the test cases we put our project through with the results of those cases.

#### PostMortem.doc

This document describes the end of the development process and what we got out of the project, including metrics of what we did, our process, and the lessons we learned.

#### 5. Included Source Code

We have included all of our source code in this package.

#### Bin

GhostClub.swf – This is the release of the game

Graphics – This folder contains all of the images used in the game

Obj – Folder used by the FlashDevelop program

snapshots – Contains pictures of the game during development

src – Contains all of the source code files for the game

Action – Part of the ghost abilities

AIController – Controller class for the ghost hunter AI

AIMaster – Master class for the ghost hunter AI

AIZone – Zone specific controller for the ghost hunter AI

Cold – Class for the cold spot ability

Collectable – Class for items that are collectable

GhostHunter – Class that controls the ghost hunter animations and actions

HelpState – Controls the help page

Ignite – Class for the hot spot ability

Images – Class for images used in the game

IsoMap – Class for representing a map in the game

IsoObject – Class for representing objects like furniture in the game

LoseState – Controls the lose screen

Main – Main file loaded first when the game is run, transfers instantly to playstate

MapEditor – File that controls the map editor

MapFile – File that controls taking in the map file and turning it into a isomap

Menu – Controls the abilities menu

MenuButton – Class for each ability button

MenuState – Controls the main screen menu

Note – Class for notes found in the game

Orb – Class for the orb ability

Overlay – Controls the overall in the game

PlayState – The first real file called by main.as when the game loads, this calls most of the other files and controls the flow of the game.

Preloader – Controls the loading of the game and load bar

State – Class for different states like menu, win, lose, and main game

UserEvent – Class for events caused by the user like clicks and key presses

WeaponPiece – Class for pieces of the ghost killer machine found on the level

cold.swf – Flash file with the animation for the cold spot ability

fire.swf – Flash file with the animation for the hot spot ability

Ghost Club.as3proj – FlashDevelop project for the game

map.txt – File that contains the integer array for the game

Motivation/Opportunity

The Ghost Game will be an exciting and fun to play game that will be set in the Ghost Club scenario. This game, unlike some other games that are based on other media such as movies, will be a quality game that is fun to play and can stand alone while being part of a multi-media exploration of a story.

### Problem Statement

The problem	Creating an exciting game that explores a story
of	from another media
affects	Target gaming audience with some Ghost Club



<p>the impact of which is</p> <p>a successful solution would be</p>	<p>exposure</p> <p>Games that are boring on their own, or do not stay true to their stories cannon</p> <p>A game that can stand alone, being fun to play and exciting, while still exploring the story from another media and staying true to its cannon</p>
---	--

Product Position Statement

<p>For</p> <p>Who</p> <p>Our System</p> <p>That</p> <p>Unlike</p> <p>Our Product</p>	<p>Target gaming audience with some Ghost Club exposure</p> <p>Play the game</p> <p>is all software</p> <p>is a enjoyable standalone game that also explores a story from another media</p> <p>other games that are either boring on their own, violate their stories cannon, or are slaves to the movies</p> <p>is exciting and successful as a game on its own but also gives a new experience of a story already told from another media</p>
--	---

## User Demographics

The main users of our Ghost Flash Game will be the players of the game. The users want to be able to play the game without difficulty. This means the users should be able to quickly load, start, and enjoy the game with minimal required learning or cognitive load. The users want to enjoy the game, having the maximum amount of fun possible. The users are expected to have experience playing some previous games. This would lead them to have a basic understand concepts like allies, enemies, health, and usable tools. The users might also have some experience with some other aspect of the Ghost Club which would give them greater insight into goals and plot.

## Feature List

Fear Meter – Meter above each ghost club member that represents that persons fear.

Fear should increase when abilities are used near a ghost club member

Ghost Abilities – These are the abilities that the user will be able to do in the environment to affect the ghost club members.

Hot spots – Fire engulfs an area

Cold spots – Ice engulfs an area

Moan – A moan/shriek is played in the mansion

Orbs – Floating orb of light displayed

AI for Ghost Club Members

Flocking – The members should try to stay near each other naturally

Interesting Points – The members should want to investigate interesting points

Ghost club members should not be able to pass through any area of impassable tiles

Response to notes – The members should respond to hints in notes they find

Response to hot spot – The members should avoid hot spots

Response to cold spots – The members should avoid cold spots

Response to orbs – The members should be interested and go toward orbs

Level Design – How the level is set up and displayed

Furniture should be placed around the level

Furniture should be surrounded by impassable tiles

Walls should be surrounded by impassable tiles

Interesting spots placed on the level

Ghost machine parts placed on the level

Character Design

Characters have move animations displayed as they move around

Animation

Fire animation – Display flames rising when hot spot cast

Ice animation – Display ice/coldness rising when cold spot cast

Orb animation – Display a floating orb when orb spell is cast

Characters should have an animation to show they are near an interesting spot

Note should appear and rise to top left of screen when found by ghost club

members

Text of note should be displayed when the note is moused over.

Lose Scenario

Ghost club members should find pieces of a Ghost Death Machine around the level

Collecting all of the pieces of the Ghost Death Machine should cause the game to end

When the game ends a lose screen should be displayed

Lose screen should have option to go back to home screen to play again

Title screen

When the game loads a title screen should be displayed

Help button – Should be a button that leads to directions

Start button – Should be a button that starts the game

Sound effects

Moan – When moan ability is cast a moan should be played as a sound file

Constraints

Use Adobe Flex

Use Flixel

Must not violate the Ghost Club Cannon

Must not give away any of the plot of the movie or other Ghost Club projects

First time users should be able to start playing and understand the game quickly with minimal learning required

Should be hosted on multiple different sites to increase availability

Should have well commented code for future developers

Should have a way for non-coders to create new maps and implement them into the game

Should have an easy way to add new abilities into the game for future developers

Use Cases

Use Case 2.a: Hot spot ability cast

Primary Actor: User wants to cast the ability

Stakeholders and Interests: None

Preconditions: None

Post-conditions: The AI should recognize that an ability was cast at a particular location and behavior differently around that given location.

Main Success Scenario:

User clicks on the Hot Spot button.

System displays that Hot Spot is selected.

User clicks on the map to cast the ability.

System displays the animation for the ability on the map at the location chosen and passes location to AI.

Extensions and Alternative Flows:

Fear is not high enough for the ghost club members

AI should treat the ability as though it is less effective

Open Issues: None

Use Case 2.b: Cold spot ability cast

Primary Actor: User wants to cast the ability

Stakeholders and Interests: None

Preconditions: None

Post-conditions: The AI should recognize that an ability was cast at a particular location and behavior differently around that given location.

Main Success Scenario:

User clicks on the Cold Spot button.

System displays that Cold Spot is selected.

User clicks on the map to cast the ability.

System displays the animation for the ability on the map at the location chosen and passes location to AI.

Extensions and Alternative Flows:

Fear is not high enough for the ghost club members

AI should treat the ability as though it is less effective

Open Issues: None

Use Case 2.c: Moan ability cast

Primary Actor: User wants to cast the ability

Stakeholders and Interests: None

Preconditions: None

Post-conditions: The AI should recognize that an ability was cast and behavior appropriately

Main Success Scenario:

User clicks on the moan button.

System plays the audio for the moan ability and sends the information to the AI

Extensions and Alternative Flows:

Fear is not high enough for the ghost club members

AI should treat the ability as though it is less effective

Open Issues: None

Use Case 2.d: Orb ability cast

Primary Actor: User wants to cast the ability

Stakeholders and Interests: None

Preconditions: None

Post-conditions: The AI should recognize that an ability was cast at a particular location and behavior differently around that given location.

Main Success Scenario:

User clicks on the Orb button.

System displays that Orb ability is selected.

User clicks on the map to cast the ability.

System displays the animation for the ability on the map at the location chosen and passes location to AI.

Extensions and Alternative Flows:

Fear is not high enough for the ghost club members

AI should treat the ability as though it is less effective

Open Issues: None

Use Case 6.f: Read note

Primary Actor: User wants to read a note

Stakeholders and Interests: None

Preconditions: Must have at least one note found already

Post-conditions: Note should be displayed

Main Success Scenario:

User mouses over the picture of a note.

System displays the the text of the note.

Extensions and Alternative Flows: None.

Open Issues: None

Use Case 7.d: Lose Screen play again

Primary Actor: User wants to go back to home screen to play again

Stakeholders and Interests: None

Preconditions: Must be at lose page

Post-conditions: Home page should be displaying

Main Success Scenario:

User clicks on the play again button

System displays the the Home Page.

Extensions and Alternative Flows: None.

Open Issues: None



#### Use Case 8.b: Help Menu

Primary Actor: User wants to display help menu

Stakeholders and Interests: None

Preconditions: Must be at title page

Post-conditions: Help page should be displaying

Main Success Scenario:

User clicks on the Help button.

System displays the the Help Page.

Extensions and Alternative Flows:

User wants to go back to home and clicks back button

System displays home page again

Open Issues: None

#### Use Case 8.c: Start Button

Primary Actor: User wants to start the game

Stakeholders and Interests: None

Preconditions: Must be at title page

Post-conditions: Game should be started

Main Success Scenario:

User clicks on the Start button

System should switch the the play game state

Extensions and Alternative Flows:

User wants to quit the game and go back home by clicking quit button.

System displays home page again

Open Issues: None

Brainstorming and Discovery

Game Idea #1:

This game idea was suggested by Jeff, inspired by a game called Maniac Mansion. In this game idea you would be controlling the Humans playing against the computer Ghosts. Each human has specialized skills, like in the movie, therefore would have their own roles. The game would follow a similar progression as the movie, with the characters coming in together, then breaking off alone or in sets. The player can only control one set of characters at a time, and must alternate between sets. If a set is left alone for too long, they can be captured, and will not be able to be controlled until they are saved by the player utilizing a different set of characters. This would be true to the story, with various teams running into issues, and the other teams trying to save them and escape the mansion alive.

Game Idea #2:

In this game the player will control the Ghosts. This game will look at the same story as the movie, but from another point of view. Each level in the game will be based on the 5 different main Ghosts and their respective areas of the mansion. The Ghost Club comes in, and it is the players (Ghosts) goal to get rid of them. There could be a fear meter that represents how afraid the Ghost Club members are. The goal of the game would be to raise the fear meter with smaller acts (such as cold spots, faces in mirrors,

etc) to lure in the Ghost Club members initially, and to break them up from larger groups. The player will have generic ghost powers all the time, and in each room will have more specialized powers based on which ghost lives there. Once the fear levels are raised up high enough, the player can use finishing ghost moves like combustion, freezing, or possession on vulnerable Ghost Club members. For repeatability there could be scoring based on time taken to rid the mansion of the Ghost Club members, or increasing difficulty based on more humans or more resilient humans.

#### Game Idea #3:

This game idea is based more on a detective style game. Each level would be a particular room based on the 5 main Ghosts. The level would probably be a still frame picture of the area. Players would use multiple tools along with clicking to interact with the picture to try to solve/figure out what is going on. By clicking the right areas, and using the right tools, the player (as a Ghost Club member) can try to get evidence of the existence of the Ghost in that area. Limited replayability.

#### Introduction

Our project is to develop a flash based video game that explores the Ghost Club's story and history. We will be using FlashDevelop along with Flixel to create the game, and host it on a variety of game websites, along with personal websites.

#### Strategy

Jeff will be responsible for the quality responsibilities for the actual game since he has the most experience with game design and the given technologies. All of the group members will be responsible for aiding him in this process as we have all coded parts of the game and will be responsible for those parts. Since Brian has been responsible for all of the documents and other non-source code contributions to the project, he will also be responsible for the quality of these items. We will be doing a few of the major types of testing on our system. The beginning will consist of mostly unit tests. This is because we need to be able to test smaller parts of the code before the entire system is built. Using unit tests we will be testing individual classes and methods as we create them to make sure they work alone before we combine them into the system. Next up we will do integration testing. This will be done after we have done the unit tests and are adding the functionality together. Once we have the individual parts proven working, and we will use the integration testing to make sure the methods communicate well with each other and with the system as a whole. Later in the process once we have a more complete version of our game, we will start the next few phases of testing. This is when we will do system tests on our program. We will want to use the entire system as a whole, and make sure that everything works together, flows correctly, and does not have errors that could only be realized once the system is whole. We will also do small amounts of usability testing at this point. We will have friends, our client, and ourselves play through the game and try to look at usability criteria. This could include how obvious certain controls are or other game play related issues. We will be using mostly black box testing, especially for the latter phases of testing. Once everything is put together, we want to look at the final product and see how things work from the outside. We will be using no

real formal bug tracking system, but open editing of a spreadsheet shared amongst the group to track and resolve bugs as they are found. We will be using the terms of severe/mild, along with fixed/unfixed to identify the states of our bugs.

### Adequacy Criterion

For our testing to be done and our project to be successful there are a few goals in mind. First off we want to test all of our use cases. We will go threw and try to execute the actions and make sure that each use case works as desired without error. We will also look at our features that do not come up in use cases. For each feature in the feature list that is not covered in a use case, we will execute the code that controls that feature. Each feature should be tested under one of these two plans.

T e s t #	Requirement Purpose	Action / Input	Expected Result	Actual Result	P / F	Notes
1	Fear meter increase when ghost club member is near hot spot	Cast the hot spot ability near a ghost club member	Fear meter should increase	Fear meter increases correctly	p	
2	Fear meter increase when ghost club member is cold hot spot	Cast the cold spot ability near a ghost club member	Fear meter should increase	Fear meter increases correctly	P	
3	Fear meter increase when ghost club member is near an orb	Cast the orb ability near a ghost club member	Fear meter should increase	Fear meter increases correctly	P	
4	Fear meter increase when the moan ability is used	Cast the moan ability	Fear meter should increase	Fear meter increases correctly	P	

5	Fire animation should show up when hot spot ability is cast on the map	Cast the hot spot ability on the map	Fire animation should play where the ability was cast on the map	Fire animation plays	P	
6	Ice animation should show up when cold spot ability is cast on the map	Cast the cold spot ability on the map	Ice animation should play where the ability was cast on the map	Ice animation plays	P	
7	Orb animation should show up when orb ability is cast on the map	Cast the orb animation on the map	The orb animation should play where the ability was cast on the map	Orb animation plays	P	
8	Check flocking AI	Start a new game and cast no abilities	Ghost club members should travel near each other going to the same rooms	Members travel together when left alone	P	
9	Check Interesting points	Start a new game and wait for ghost club members to find an interesting spot	Ghost club members should stay and wander around that spot until they find a note or a long time passes	Members stay near a spot wandering around until they find the note	P	
10	Impassable Terrain	Start a new game	Ghost club members should never walk threw a wall or any area with impassable tiles	Members never go threw a wall or furniture	P	

1 1	AI response to notes	Start a new game and wait for ghost club members to find a note with a clue	Ghost club members should gain interest in the area mentioned in the note, and start heading that way	Members went to the location mentioned in the note	P	
1 2	AI response to hot spots	Cast hot spot ability near a ghost club member	Ghost club member should avoid the hot spot	Nothing	F	Changed goal, characters should not avoid, just get afraid
1 3	AI response to cold spots	Cast cold spot ability near a ghost club member	Ghost club member should avoid the cold spot	Nothing	F	Changed goal, characters should not avoid, just get afraid
1 4	AI response to orbs	Cast orb ability near a ghost club member	Ghost club member should avoid the orb	Nothing	F	Changed goal, characters should not avoid, just get afraid
1 5	Furniture should be surrounded by impassable tiles	Open up the map in the map editor	Orange impassable terrain tiles should surround all furniture	Furniture is surrounded by impassable terrain tiles	P	
1 6	Walls should be surrounded by impassable tiles	Open up the map in the map editor	Orange impassable terrain tiles should surround all walls	Walls are surrounded by impassable terrain tiles	P	
1 7	Characters move animations	Start a new game	Ghost club members should display moving animations as they move	Move animations show up	P	

18	Characters find interesting spot animation	Start a new game and wait for characters to find interesting spot	Ghost club members should have question marks flash above their heads periodically	Question mark appears over members heads	P	
19	Text appear for notes	Start a new game, wait for characters to find a note, and mouse over it	Text should be displayed where the cursor is that shows that the note reads	Text appears correctly	P	
20	Notes found	Start a new game, wait for characters to find a note	The note should appear in the top left corner of the screen	Note appears in top left	P	
21	Lose screen	Start a new game, wait for the characters to find all of the parts of the machine	The game should end and the lose screen should be displayed	All parts are found, warning that game is ending displays, game ends	P	
22	Machine parts	Start a new game	Characters should find machine parts on the level	Characters find machine parts on the level	P	
23	Play again option	Start a new game and lose, going to lose screen, click play again	Home screen should be displayed	Home screen is displayed	P	
24	<b>Title Screen</b>	<b>Start the application</b>	<b>Home screen should be displayed</b>	<b>Title screen shown</b>	<b>P</b>	
25	<b>Help button</b>	<b>Start the application and click</b>	<b>Help menu should be displayed</b>	<b>Help menu displayed</b>	<b>P</b>	



		the help button				
26	Start button	Start the application and arrive at home screen then click play	The game should start	Game starts	P	
27	Moan sound effect	Start a new game and click on the moan ability	The moan sound effect should play	No sound is played, game errors	F	Removed moan functionality

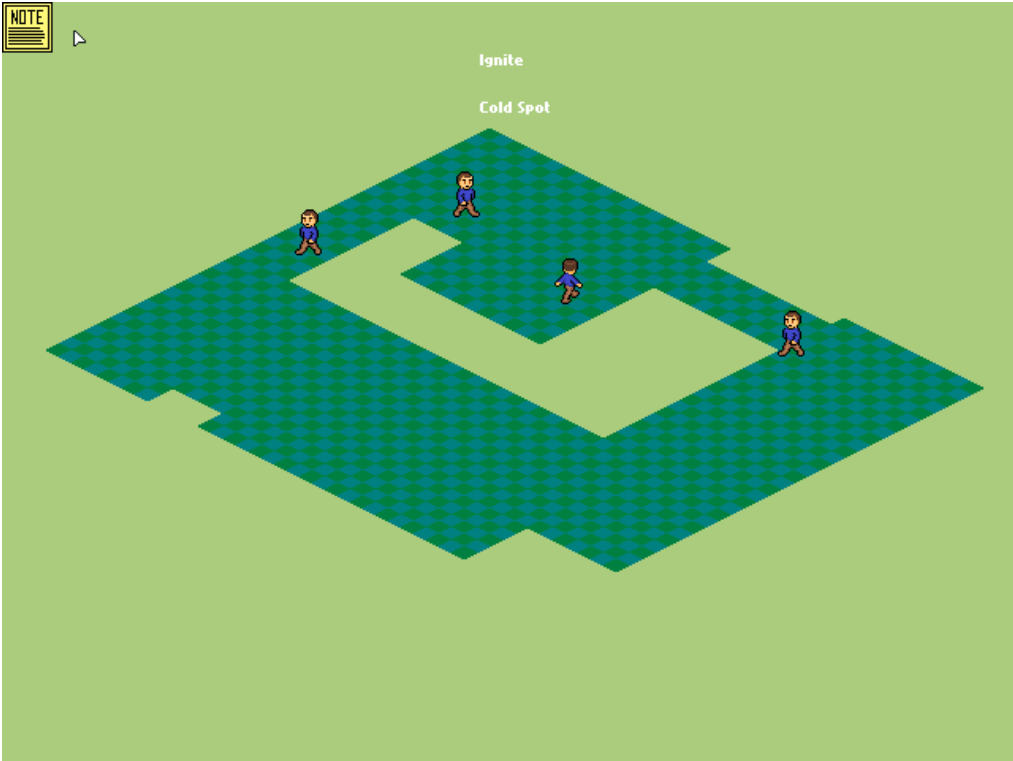
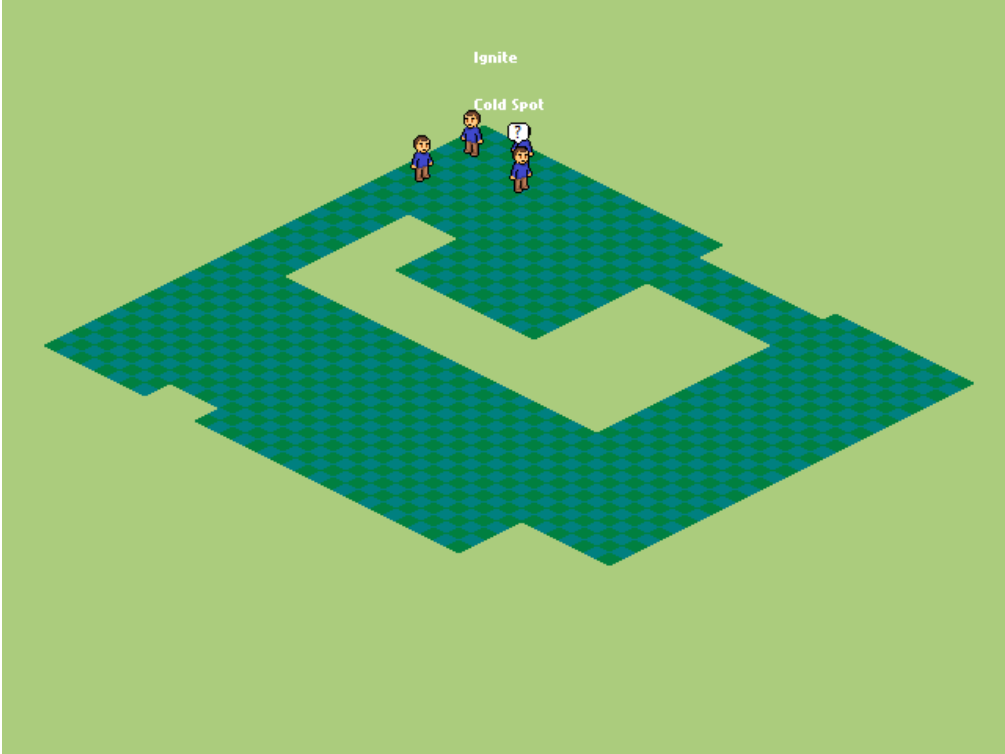



There's a ghost in this house, you should run away as fast as you can!!

Ignite

Cold Spot

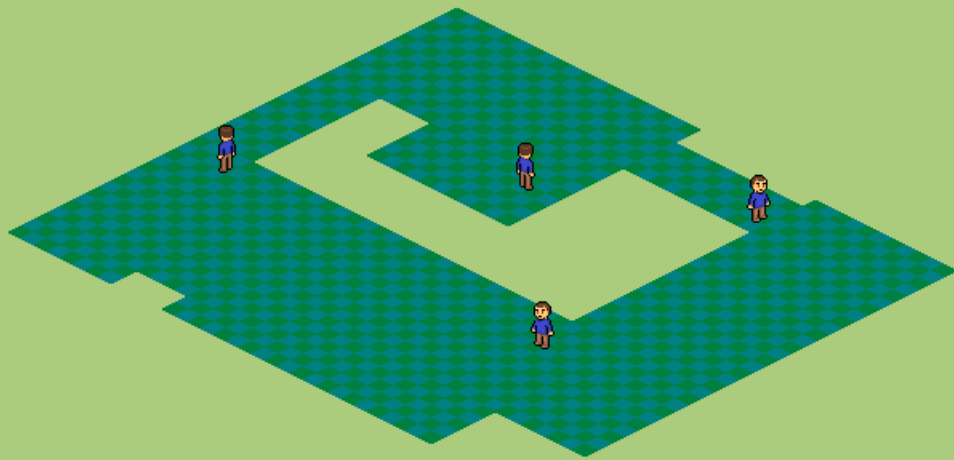

Ignite

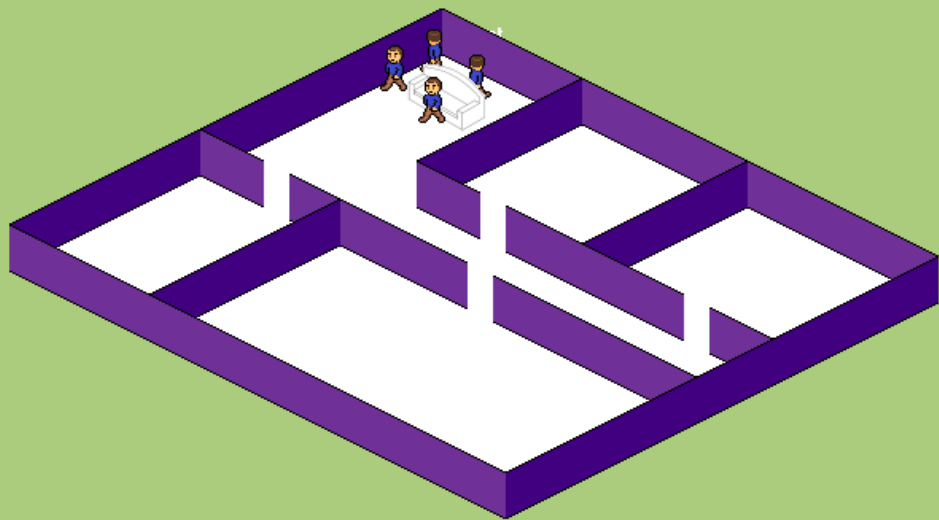

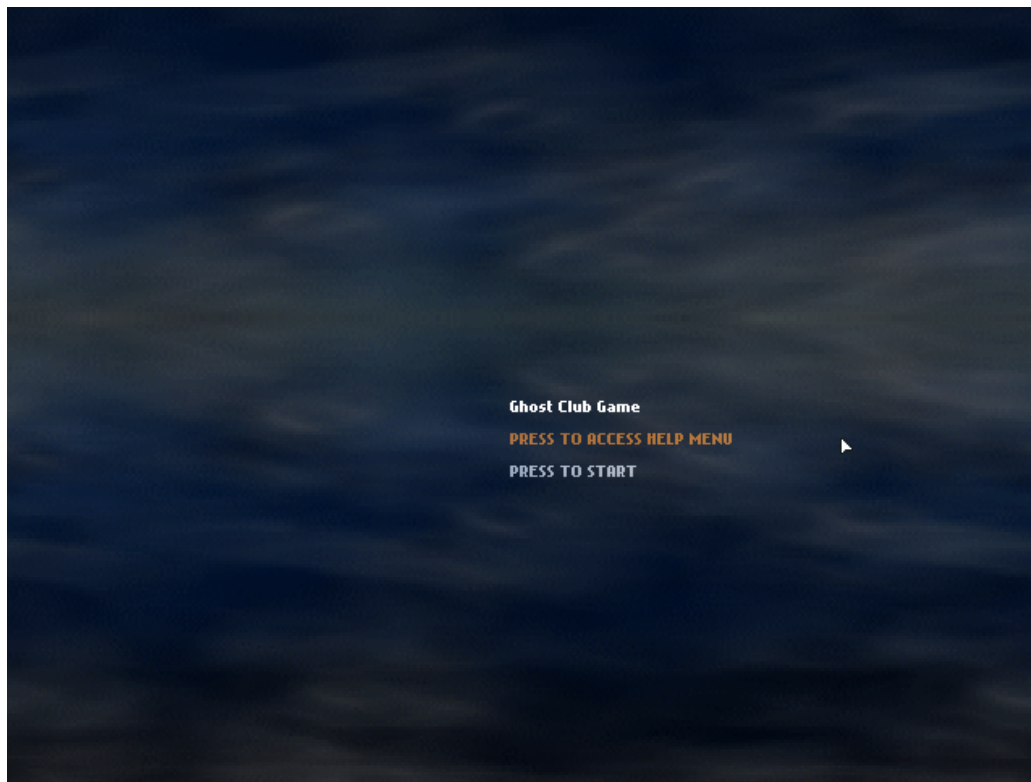
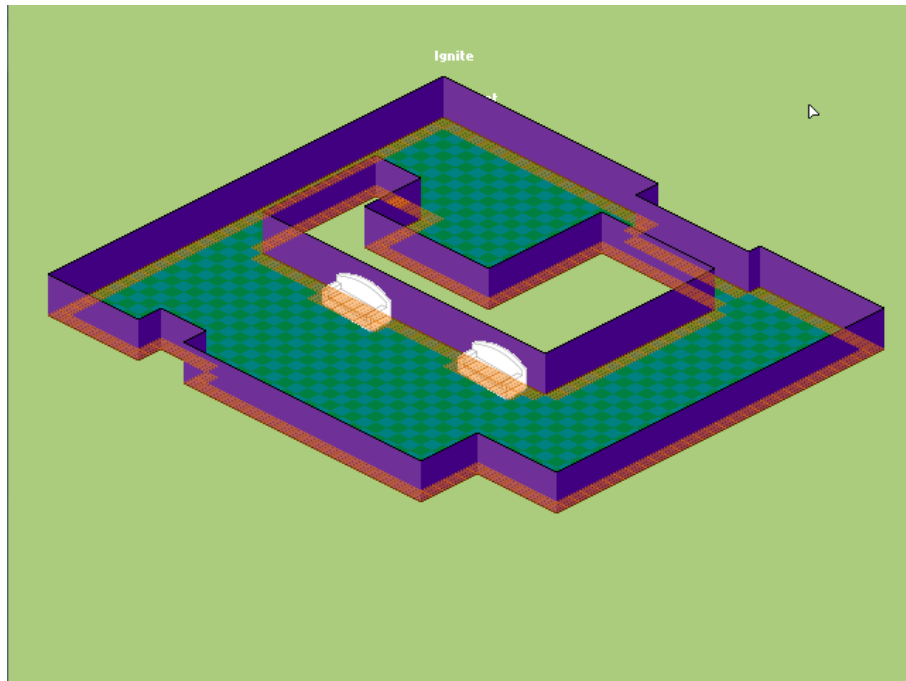

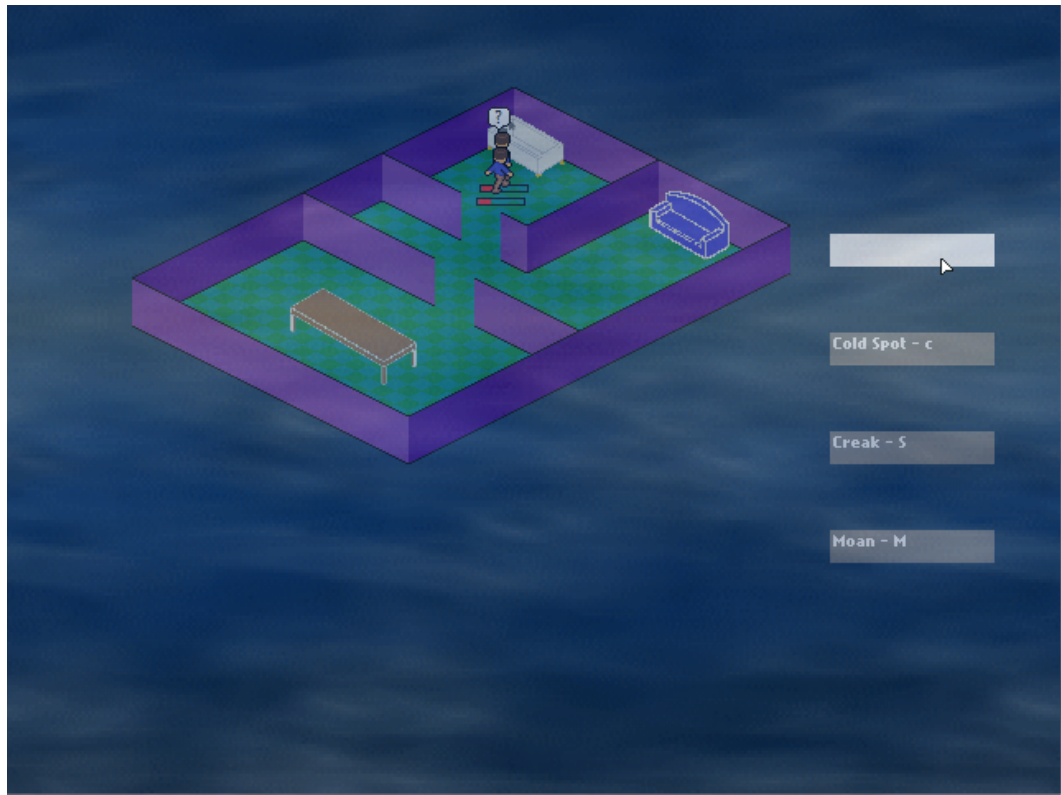

## ***Flash Game 2***

### Game Idea #1:

This game idea was suggested by Jeff, inspired by a game called Maniac Mansion. In this game idea you would be controlling the Humans playing against the computer Ghosts. Each human has specialized skills, like in the movie, therefore would have their own roles. The game would follow a similar progression as the movie, with the characters coming in together, then breaking off alone or in sets. The player can only control one set of characters at a time, and must alternate between sets. If a set is left alone for too long, they can be captured, and will not be able to be controlled until they are saved by the player utilizing a different set of characters. This would be true to the story, with various teams running into issues, and the other teams trying to save them and escape the mansion alive.

### Game Idea #2:

In this game the player will control the Ghosts. This game will look at the same story as the movie, but from another point of view. Each level in the game will be based on the 5 different main Ghosts and their respective areas of the mansion. The Ghost Club comes in, and it is the players (Ghosts) goal to get rid of them. There could be a fear meter that represents how afraid the Ghost Club members are. The goal of the game would be to raise the fear meter with smaller acts (such as cold spots, faces in mirrors, etc) to lure in the Ghost Club members initially, and to break them up from larger groups. The player will have generic ghost powers all the time, and in each room will have more

specialized powers based on which ghost lives there. Once the fear levels are raised up high enough, the player can use finishing ghost moves like combustion, freezing, or possession on vulnerable Ghost Club members. For repeatability there could be scoring based on time taken to rid the mansion of the Ghost Club members, or increasing difficulty based on more humans or more resilient humans.

**Game Idea #3:**

This game idea is based more on a detective style game. Each level would be a particular room based on the 5 main Ghosts. The level would probably be a still frame picture of the area. Players would use multiple tools along with clicking to interact with the picture to try to solve/figure out what is going on. By clicking the right areas, and using the right tools, the player (as a Ghost Club member) can try to get evidence of the existence of the Ghost in that area. Limited replayability.

**Game Idea #1: <http://www.youtube.com/watch?v=WiBx1ndz3GY>**

**Story scape:**

Parallels the story of the movie in its entirety. Also fits in because the characters must rely on the gadgets in the game, which is an important aspect of the movie. The characters and ghosts would be the same as the movie. Very related.

**Graphic style / presentation:**

Side scroller style. 2D with some level of depth. Doors you can go in. Can go in front or behind objects.

**What role play:**

Control Ghost Club members

**General Game Play:**

Switching between the groups, with different groups having different specialties based on who is in the group / which tools they have available. Leaving a group alone for too long leads to being “captured” and needs to be rescued. Options to be expanded if needed.

**Game Idea #2:**<http://www.youtube.com/watch?v=Z5EVBk81UMU>

**Story scape:**

Tells the story from a different point of view. Looks at how the ghosts view what is happening. Relates to the story by using ghost powers that were exhibited in the movie. Different story style, but the same aspect. Beginning elements are there, but things change a bit. Can vary from the movie based on how well the users do. Would stand alone from the movie more than other ideas.

**Graphic style / presentation:**

Not controlling individual characters, but will be clicking around. Overview of the entire mansion with at top down view. See what is happening, but don't move around individual thing.

**What role play:**

Control the ghosts.

**General Game Play:**

Trying scare aware the humans. Replay available increasing difficulty or scores. More of a heads up display than the first idea. Need to display what powers are



available, fear meter, etc. Doing too much big ghost activity too soon will lead to the Ghost Club members getting evidence or noticing you, and you will lose the game.

**Game Idea #3:**

**Story scape:**

Not as much as an overall of the story, but breaking down a few certain scenes and elaborating on them.

**Graphic style / presentation:**

More still pictures, limited interaction. Could possibly use actual photos of the house / movie for the graphics.

**What role play:**

Ghost Hunters

**General Game Play:**

Revolves heavily on gadgets. Trying to use tools to gather evidence. Could go threw a story having to get threw levels to get out of the mansion. Break down of the escape part of the game.

## Motivation/Opportunity

The Ghost Game will be an exciting and fun to play game that will be set in the Ghost Club scenario. This game, unlike some other games that are based on other media such as movies, will be a quality game that is fun to play and can stand alone while being part of a multi-media exploration of a story.

## Problem Statement

The problem of	Creating an exciting game that explores a story from
affects	another media
the impact of	Target gaming audience with some Ghost Club
which is	exposure
a successful	Games that are boring on their own, or do not stay
solution would be	true to their stories cannon
	A game that can stand alone, being fun to play and
	exciting, while still exploring the story from another media
	and staying true to its cannon

## Product Position Statement

For	Target gaming audience with some Ghost Club
Who	exposure
	Play the game

Our System	is all software
That	is a enjoyable standalone game that also explores a story from another media
Unlike	other games that are either boring on their own, violate their stories cannon, or are slaves to the movies
Our Product	is exciting and successful as a game on its own but also gives a new experience of a story already told from another media

### **User Demographics**

The main users of our Ghost Flash Game will be the players of the game. The users want to be able to play the game without difficulty. This means the users should be able to quickly load, start, and enjoy the game with minimal required learning or cognitive load. The users want to enjoy the game, having the maximum amount of fun possible. The users are expected to have experience playing some previous games. This would lead them to have a basic understand concepts like allies, enemies, health, and usable tools. The users might also have some experience with some other aspect of the Ghost Club which would give them greater insight into goals and plot.

### **Feature List**

Fear Meter – Meter above each ghost club member that represents that persons fear. Fear will be a measure of what abilities can be used on the particular person. Fear will change based on abilities used near those persons.

Ghost Abilities – These are the abilities that the user will be able to do in the environment to affect the ghost club members.

Interacting/Moving objects

Display face in mirror

Flickering lights

Hot/Cold spots

Creepy Noises

Combustion

Possession

Orbs

Making walls bleed

Shadows – Shadows of the players and objects

AI – How the ghost club members will move around and respond to user interactions

Level Design – How the level is set up and displayed

Character Design – How the ghost club characters will look

Animation – How things will be animated, especially ghost abilities, characters, and interactions

Level expansion – How we move from level to level, or in-between one level

Save Files

Ghost Detection – How the ghost club members can detect your presence

Lose Scenario – How you lose, and what happens when you do

Title screen

Sound effects / Background music

### **Constraints**

Use Adobe Flash

Must not violate the Ghost Club Cannon

Must not violate the Ghost Genre without explicit acceptance

Should be easy to use for first time users

Should be put online to be always available on multiple sites

Should have clean and clear code that is easy to follow, update, and maintain

### **Use Cases**

Use Case 01: Fear Meter

Primary Actor: Player

Stakeholders and Interests: Player

Preconditions: None, its always there.

Postconditions: None, its always there.

Main Success Scenario:

Fear meter increases when valid tactics are used

Fear meter decreases when mistakes are made

Fear meter decreases when people group up

Fear meter decreases when they find tools

Fear meter increases when people split up

Extensions and Alternative Flows:

None

Use 02: Ghost Abilities

Primary Actor: Player

Stakeholders and Interests: Player

Preconditions: Adequate level of fear from the fear meter

Postconditions: Increase fear, or do desired effect

Main Success Scenario:

Performs animation

Characters respond

Extensions and Alternative Flows:

None

Use 11: Lose Detection

Primary Actor: Player

Stakeholders and Interests: Player

Preconditions: Fear meter is zero or gather evidence threw use of tools

Postconditions: Game over, kick back to title screen or restart options displayed

Main Success Scenario:

Fear meter reaches zero or evidence is gathered

Game ends and is brought to end game screen

Extensions and Alternative Flows:

None

## **Brainstorming and Discovery**

### Game Idea #1:

This game idea was suggested by Jeff, inspired by a game called Maniac Mansion. In this game idea you would be controlling the Humans playing against the computer Ghosts. Each human has specialized skills, like in the movie, therefore would have their own roles. The game would follow a similar progression as the movie, with the characters coming in together, then breaking off alone or in sets. The player can only control one set of characters at a time, and must alternate between sets. If a set is left alone for too long, they can be captured, and will not be able to be controlled until they are saved by the player utilizing a different set of characters. This would be true to the story, with various teams running into issues, and the other teams trying to save them and escape the mansion alive.

### Game Idea #2:

In this game the player will control the Ghosts. This game will look at the same story as the movie, but from another point of view. Each level in the game will be based on the 5 different main Ghosts and their respective areas of the mansion. The Ghost Club comes in, and it is the players (Ghosts) goal to get rid of them. There could be a fear meter that represents how afraid the Ghost Club members are. The goal of the game would be to raise the fear meter with smaller acts (such as cold spots, faces in mirrors, etc) to lure in the Ghost Club members initially, and to break them up from larger groups.

The player will have generic ghost powers all the time, and in each room will have more specialized powers based on which ghost lives there. Once the fear levels are raised up high enough, the player can use finishing ghost moves like combustion, freezing, or possession on vulnerable Ghost Club members. For repeatability there could be scoring based on time taken to rid the mansion of the Ghost Club members, or increasing difficulty based on more humans or more resilient humans.

#### Game Idea #3:

This game idea is based more on a detective style game. Each level would be a particular room based on the 5 main Ghosts. The level would probably be a still frame picture of the area. Players would use multiple tools along with clicking to interact with the picture to try to solve/figure out what is going on. By clicking the right areas, and using the right tools, the player (as a Ghost Club member) can try to get evidence of the existence of the Ghost in that area. Limited replayability.



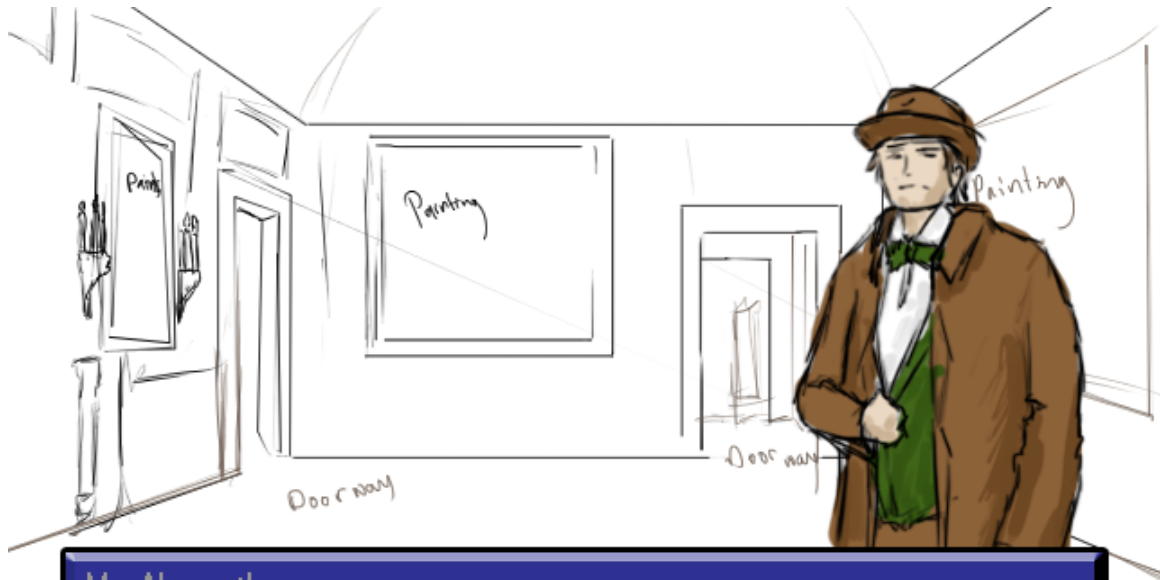

Mr. Abernathy

I heard that [insert tragedy] occurred here [some time] ago. . .

Next

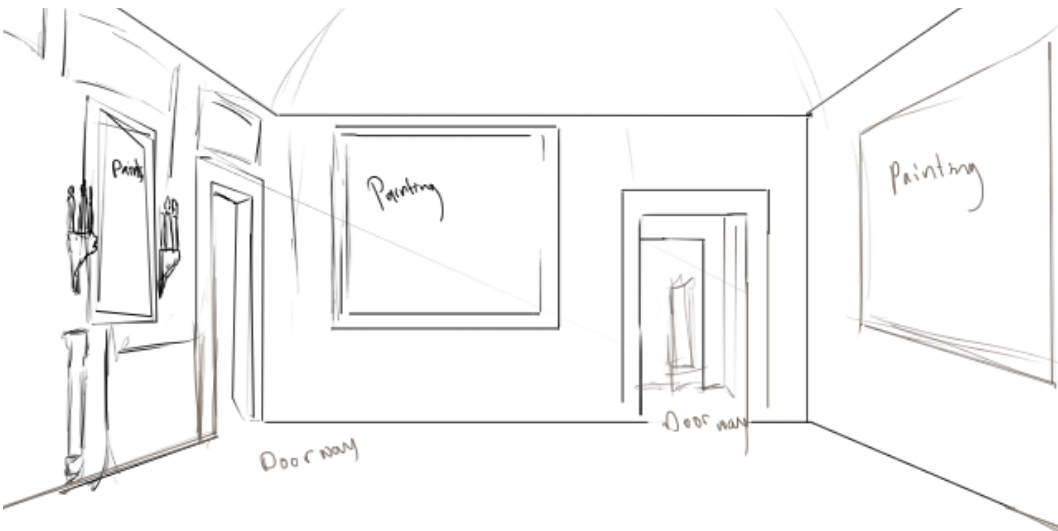

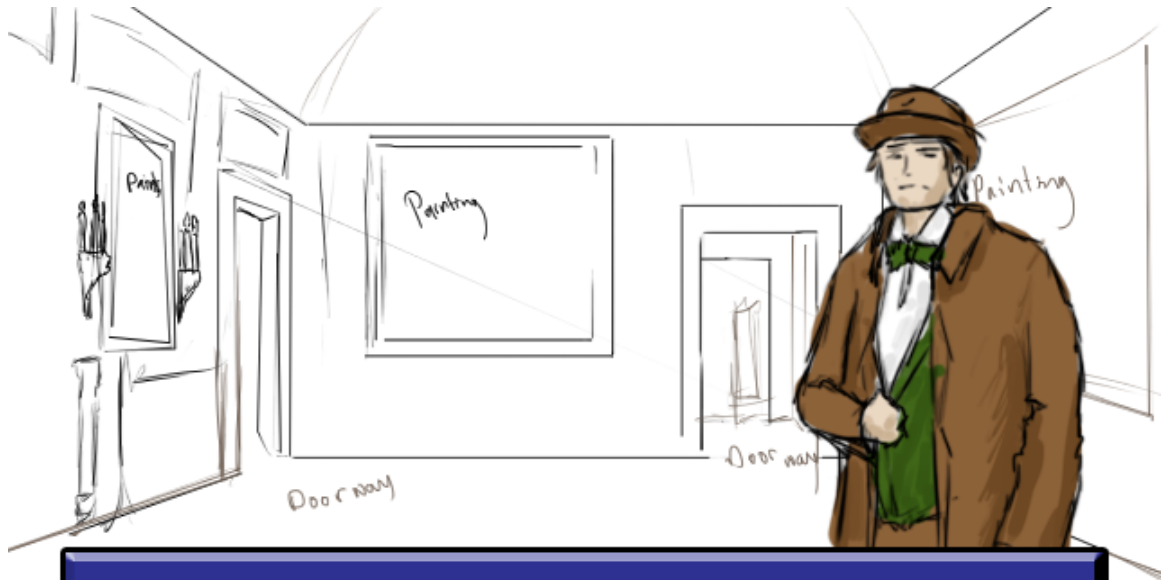

- ▶ Ask about [Insert Tragedy]
- > Ask about [Painting]
- > Show [Key Item]
- > Nevermind

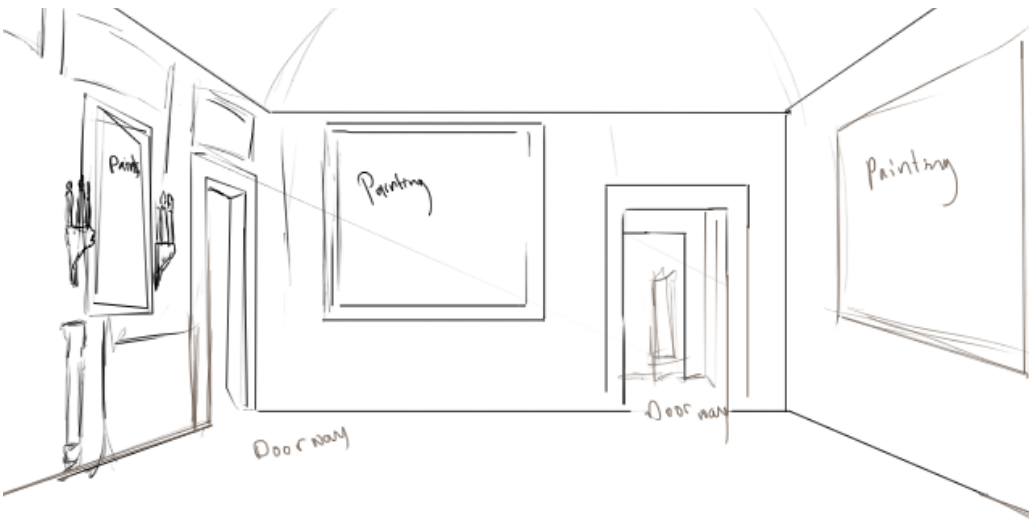

## Ghost Club Flash Game

### The Ghost Club Flash Game

Product Vision Statement

#### Motivation/Opportunity

We are building this product as a piece of a storyscape related to *The Ghost Club*. *The Ghost Club* franchise spans multiple media artifacts, and our task is to build the interactive Flash game facet of the storyscape. The goal of constructing the storyscape is to further our client's research in the field of transmedia storytelling.

#### Problem Statement

The problem of	ineffective transmedia storytelling caused by a lack of diverse media artifacts
affects	media creators and their audiences
the impact of which is	weak franchises and disappointed audiences
a successful solution would be	more diverse media artifacts to support a richer storyscape

#### Product Position Statement

For	people who are partial to settings similar to that of our storyscape
Who	enjoy playing flash games
Our System	is a flash game built for any platform with strong Flash support
That	enables users to play our game and experience part of The Ghost Club's storyscape.
Unlike	countless other non-transmedia flash games
Our Product	draws the player into a larger storyscape while also entertaining the player.

#### User Demographics

The users that the Ghost Club game targets people partial to settings similar to that of our storyscape. This demographic includes two key audiences - existing fans, and non-fans (whether they are familiar with The Ghost Club or not). Existing fans may be emotionally and intellectually invested

in The Ghost Club's mythology and universe, so for this demographic, it is more important that a game placed in the franchise's setting avoid violating its canon and mythology. On the other hand, non-

fans lack this investment, so as entertainment software, the primary expectation is that our software provides entertainment. Hopefully the entertainment value of the game, combined with its presentation of part of The Ghost Club's storyscape, will be able to appease existing fans while introducing (and hopefully making new fans of) non-fans. Gameplay accessibility is also an important requirement for both fans and non-fans alike, since inaccessible game controls frustrate and drive away inexperienced players.

#### Feature List

See Pivotal Tracker.

#### Constraints

- Must use Adobe Flash

- Must not violate The Ghost Club's cannon
- Must not contain inappropriate or offensive content
- Must use accessible controls

**User Stories**

See Pivotal Tracker.

|: :|

## REFERENCES

- Aarseth, Espen J. 1997. *Cybertext: Perspectives on Ergodic Literature*. Baltimore, Md: Johns Hopkins University Press.
- Andersen, Michael. 2011. "Game of Thrones Ask Fans to Play Mouth-Watering Metagame." *Wired*, May 5.
- Aristotle. 1968. *Aristotle on the Art of Fiction; an English Translation of Aristotle's Poetics*. London: Cambridge U.P.
- . 1998. *Aristotle's Poetics*. New York: Hill and Wang.
- Askwith, I., H Jenkins, J. Green, and T. Crosby. 2007. "Deconstructing The Lost Experience: In-Depth Analysis of an ARG." *Convergence Culture Consortium White Paper*, no. Winter.
- Askwith, Ivan. 2003. "A Matrix in Every Medium." *Salon.com*.
- Askwith, Ivan D. 2007. "Television 2.0: Reconceptualizing TV as an Engagement Medium." Massachusetts Institute of Technology.  
<http://hrenato.net/corso/narrtran/IvanAskwith2007.pdf>.
- Azuma, Ronald. 2015. "Location-Based Mixed and Augmented Reality Storytelling." In *Fundamentals of Wearable Computers and Augmented Reality*, 2nd Edition, pp. 259–76. CRC Press.
- Baker1000. 2015. "5 Years After LOST - Why It's Wrong To Judge the Show on The End."  
[http://lostpedia.wikia.com/wiki/User\\_blog:Baker1000/5\\_Years\\_After\\_LOST\\_-\\_Why\\_It%27s\\_Wrong\\_To\\_Judge\\_the\\_Show\\_on\\_The\\_End](http://lostpedia.wikia.com/wiki/User_blog:Baker1000/5_Years_After_LOST_-_Why_It%27s_Wrong_To_Judge_the_Show_on_The_End).
- Barthes, Roland. 1972. *Mythologies*. New York: Hill and Wang.
- . 1977. *Image, Music, Text*. New York: Hill and Wang.
- Blumenthal, H., and Y. Xu. 2012. "The Ghost Club Storyscape: Designing for Transmedia Storytelling." *IEEE Transactions on Consumer Electronics* 58 (2): 190–96. doi:10.1109/TCE.2012.6227412.
- Bolter, J.D., and R. Grusin. 2000. *Remediation: Understanding New Media*. The MIT Press.
- Boni, Marta. 2013. *Romanzo Criminale Transmedia and Beyond*. Edizioni Ca' Foscari - Digital Publishing.

- Bordwell, David, and Kristin Thompson. 2010. "Now Leaving from Platform 1." *Observations on Film Art*. <http://www.davidbordwell.net/blog/?p=5264>.
- Bruner, Jerome. 1987. *Actual Minds, Possible Worlds*. Vol. 1. Harvard University Press.
- Bushman, Jay, and Margaret Dunlap. 2015. "Welcome to Sanditon." *Pemberly Digital*. January 20. <http://www.pemberleydigital.com/welcome-to-sanditon/>.
- Campbell, Joseph. 1968. *The Hero with a Thousand Faces*. [2d ed. Bollingen Series 17. Princeton, N.J.]: Princeton University Press.
- Caranicas, Peter. 2009. "Transmedia Storytelling Is Future of Biz." *Variety*, June 26. <http://variety.com/2009/film/news/transmedia-storytelling-is-future-of-biz-1118005442/>.
- Clark, Brian. 2011. "Reclaiming Transmedia Storyteller." Facebook. *Brian Clarke*. May 2. <https://www.facebook.com/notes/brian-clark/reclaiming-transmedia-storyteller/10150246236508993>.
- . 2012. "Transmedia Is a Lie." Facebook. <https://www.facebook.com/notes/brian-clark/transmedia-is-a-lie/10150841850433993/>.
- Davidson, Drew, and Et al. 2010. *Cross-Media Communications*.
- Dena, Christy. 2006. "Writing Predictions for the Next Decade." *Christy's Corner of the Universe*. January 6. <http://www.christydena.com/2006/01/writing-predictions-for-the-next-decade/>.
- . 2008. "Emerging Participatory Culture Practices: Player-Created Tiers in Alternate Reality Games." *Convergence: The International Journal of Research into New Media Technologies* Vol. 14 (February): pp. 41–57.
- . 2009. "Transmedia Practice: Theorising the Practice of Expressing a Fictional World across Distinct Media and Environments." (PhD, Australia: University of Sydney).
- . 2010. "Cross/Transmedia Story Design." The Pixel Lab, UK, July 21. <http://www.slideshare.net/christydena/crosstransmedia-story-design>.
- . 2012. "Some Things I Have Learned From Transmedia Worldbuilding." Blog. *Christy's Corner of the Universe*. <http://www.christydena.com/publications/transmedia-worldbuilding/>.
- Dowd, Tom, Michael Niederman, Michael Fry, and Josef Steiff. 2013. *Storytelling Across Worlds: Transmedia for Creatives and Producers*. 1st ed. Focal Press.
- Dundes, Alan. 1997. "Binary Opposition in Myth: The Propp/Levi-Strauss Debate in Retrospect." *Western Folklore* 56 (1): 39–50.
- Eco, Umberto. 1989. *The Open Work*. Translated by Anna Cancogni. Harvard University Press.

- Evans, E. J. 2008. "Character, Audience Agency and Transmedia Drama." *Media, Culture & Society* 30 (2): 197–213.
- Evans, Elizabeth. 2007. "Character, Audience Agency and Trans-Media Drama." *Media, Culture and Society*.
- Faulkner, William. 1957. Frederick Gwynn's American Fiction Class.  
[http://faulkner.lib.virginia.edu/display/wfaudio01\\_1](http://faulkner.lib.virginia.edu/display/wfaudio01_1).
- French, Philip. 1977. *Westerns: Aspects of a Movie Genre*. Vol. 25. Oxford University Press. <http://www.getcited.org/pub/101925488>.
- Freud, Sigmund. 1930. *Civilization and Its Discontents*. New York: J. Cape & H. Smith.
- Fritz, Ben. 2011. "Starlight Runner Entertainment Creates Mythology behind Movie Franchises." *Los Angeles Times*, February 15, sec. Movies.  
<http://articles.latimes.com/2011/feb/15/business/la-fi-ct-starlight-runner-20110215>.
- Frye, Northrop. 2006. *The Great Code: The Bible and Literature*.
- Gardner, Howard. 1996. *Intelligence: Multiple Perspectives*. Fort Worth, TX ; Toronto: Harcourt Brace College Publishers.
- . 1999. *Intelligence Reframed: Multiple Intelligences for the 21st Century*. New York, NY: Basic Books.
- Gomez, Jeff. 2009. Jeff Gomez. [http://www.forbes.com/2009/03/03/jeff-gomez-advertising-leadership-cmo-network\\_starlight\\_runner.html](http://www.forbes.com/2009/03/03/jeff-gomez-advertising-leadership-cmo-network_starlight_runner.html).
- . 2010. "Whole New Worlds: Transmedia Storytelling Opens Licensing Vistas," June 8. [http://kidscreen.com/2010/06/08/transmedialicensing-20100608/?\\_\\_b=yes%3Bword%3Dgomez](http://kidscreen.com/2010/06/08/transmedialicensing-20100608/?__b=yes%3Bword%3Dgomez).
- . 2014. This Isn't Your Grandparents' Media Campaign Website. <http://www.usnews.com/opinion/economic-intelligence/2014/03/18/jeff-gomez-discusses-legos-star-wars-and-transmedia-campaigns>.
- Gray, Jonathan. 2010. *Show Sold Separately: Promos, Spoilers, and Other Media Paratexts*. NYU Press.  
<http://books.google.com/books?hl=en&lr=&id=HSWez23WtdoC&oi=fnd&pg=PR7&dq=ivan+askwith&ots=EcY9n4jyel&sig=TDRIda7fKEAxSluoA7itm47WDj0>.
- Green, Hank, and Bernie Su. 2015. "The Lizzie Bennet Diaries." *Pemberly Digital*. February 20. <http://www.pemberleydigital.com/the-lizzie-bennet-diaries/story-lbd/>.

- Hanttula, Mike. 2012. "The 'Lost' Notebook." *The "Lost" Notebook*.  
<http://www.hanttula.com/archive/projects/lost/category/images>.
- Herman, David, Manfred Jahn, and Marie-Laure Ryan, eds. 2005. *Routledge Encyclopedia of Narrative Theory*. London: Routledge.
- heroine\_tv. 2010. "LOST: Yeah, It's Really 'The End' (Part II)." *Heroine\_tv*. June 16.  
<http://www.heroinetv.com/2010/06/16/lost-yeah-its-really-the-end-part-ii/>.
- Jenkins, Henry. 2004. "Game Design as Narrative Architecture." *First Person: New Media as Story, Performance, and Game* 118.  
<http://web.mit.edu/21fms/People/henry3/games&narrative.html>.
- . 2006a. *Convergence Culture: Where Old and New Media Collide*. New York: New York University Press.
- . 2006b. "Fan Fiction as Critical Commentary." *Confessions of an Aca-Fan*. September 27.  
[http://henryjenkins.org/2006/09/fan\\_fiction\\_as\\_critical\\_commen.html](http://henryjenkins.org/2006/09/fan_fiction_as_critical_commen.html).
- . 2007a. *The Wow Climax: Tracing the Emotional Impact of Popular Culture*. New York: New York University Press.
- . 2007b. "Transmedia Storytelling 101." *Confessions of an Aca Fan*. March 22.  
[http://henryjenkins.org/2010/04/hollywood\\_goes\\_transmedia.html](http://henryjenkins.org/2010/04/hollywood_goes_transmedia.html).
- . 2009a. "Revenge of the Origami Unicorn: The Remaining Four Principles of Transmedia Storytelling." *Confessions of an Aca-Fan*. December 12.  
[http://henryjenkins.org/2009/12/revenge\\_of\\_the\\_origami\\_unicorn.html](http://henryjenkins.org/2009/12/revenge_of_the_origami_unicorn.html).
- . 2009b. "The Revenge of the Origami Unicorn: Seven Principles of Transmedia Storytelling." Blog. *Confessions of an Aca-Fan*. December 12.  
[http://henryjenkins.org/2009/12/the\\_revenge\\_of\\_the\\_origami\\_uni.html](http://henryjenkins.org/2009/12/the_revenge_of_the_origami_uni.html).
- . 2010a. "Transmedia Storytelling and Entertainment: An Annotated Syllabus." *Continuum* 24 (6): 943–58.
- . 2010b. "The Night Of a Thousand Wizards." *Confessions of an Aca-Fan*. July 21. [http://henryjenkins.org/2010/07/fear\\_and\\_loathing\\_in\\_hogwarts.html](http://henryjenkins.org/2010/07/fear_and_loathing_in_hogwarts.html).
- . 2011a. "Transmedia 202: Further Reflections." *Confessions of an Aca-Fan*.  
[http://henryjenkins.org/2011/08/defining\\_transmedia\\_further\\_re.html](http://henryjenkins.org/2011/08/defining_transmedia_further_re.html).
- . 2011b. "Reflections on Transmedia." *Future of Film*. August 15.  
<http://tribecafilm.com/stories/51b6150ec07f5db241000002-reflections-on-transmedia>.
- . 2015. "Henry Jenkins." *Facebook*.  
<https://www.facebook.com/search/top/?q=%20by%20suggesting%20that%20his%20own%20approach%20was%20diametrically%20opposite%20of%20mine%20C%20and%20then%20utterly%20convincing%20me%20with%20his%20arguments.%E2%80%9D%20>.
- Johnson, Derek. 2014. "A History of Transmedia Entertainment." *Spreadable Media*.  
<http://spreadablemedia.org/essays/johnson/#.VDwwZr7wliF>.



- Jung, C. G. 1981. *The Archetypes and The Collective Unconscious, Collected Works 9*. 2nd ed. Princeton, NJ: Bollingen.
- Kaminsky, Stuart M. 1974. *American Film Genres: Approaches to a Critical Theory of Popular Film*. Pflaum.
- Klastrup, Lisbeth, and Susana Tosca. 2004. "Transmedial Worlds – Rethinking Cyberworld Design." In *Proceedings International Conference on Cyberworlds 2004*. Los Alamitos, California: IEEE Computer Society.
- Konzack, L. 2006. "Sub-Creation of Secondary Game Worlds." In *Games 2006: iDiG - International Digital Games Conference Proceedings*, 115–22.
- Lang, Brent. 2013. "How the Battle Over 'Star Trek' Rights Killed J.J. Abrams' Grand Ambitions." Online Magazine. *The Wrap, Covering Hollywood*. May 15. <http://www.thewrap.com/movies/article/how-web-star-trek-rights-killed-jj-abrams-grand-ambitions-91766/>.
- Laurel, Brenda. 1991. *Computers as Theatre*. Reading, Mass: Addison-Wesley Pub.
- Leane, Rob. 2015. "Why There Isn't a New Star Trek TV Series." [Http://www.denofgeek.us](http://www.denofgeek.us). June 29. <http://www.denofgeek.us/tv/star-trek/247309/why-there-isn-t-a-new-star-trek-tv-series>.
- Lévi-Strauss. 1981. *Mythologiques, The Naked Man*. Vol. 4. University of Chicago Press.
- Lévi-Strauss, Claude. 1955. "The Structural Study of Myth." *The Journal of American Folklore* 68 (270). <http://people.ucsc.edu/~ktellez/levi-strauss.pdf>.
- . 1972. "The Structural Study of Myth. Four Winnebago Myths. History and Dialectic." In *The Structuralists: From Marx to Lévi-Strauss*, edited by Richard T De George, 1st ed. Garden City, N.Y: Anchor Books.
- . 1983a. *Structural Anthropology*. University of Chicago Press ed. Chicago, Ill: University of Chicago Press.
- . 1983b. *The Raw and the Cooked*. Chicago: University of Chicago Press.
- Lévy, Pierre. 1997. *Collective Intelligence*. Plenum/Harper Collins.
- Lindelof, Damon, and J.J. Abrams. 2006. When Stephen King met the "Lost" boys...Website. <http://www.ew.com/ew/article/0,,1562722,00.html>.
- Lindelof, Damon, and Carlton Cuse. 2007. BuddyTV Interviews LOST's Damon Lindelof and Carlton Cuse - and gets Answers!Website. <http://www.buddytv.com/articles/lost/buddytv-interviews-losts-damon-4766.aspx>.
- Lønberg, Oliver, and Phillip Rasmussen. 2011. "The Pottermore Concept and Transmediality," no. November.

- Long, Geoffrey A. 2007. "Transmedia Storytelling : Business, Aesthetics and Production at the Jim Henson Company." Massachusetts Institute of Technology. <http://dspace.mit.edu/handle/1721.1/39152>.
- "Lostpedia." 2013. Accessed March 23. [http://lostpedia.wikia.com/wiki/Main\\_Page](http://lostpedia.wikia.com/wiki/Main_Page).
- Manovich, Lev. 2002. *The Language of New Media*. 1st MIT Press pbk. ed. Cambridge, Mass: MIT Press.
- Mateas, Michael. 1998. "A Preliminary Poetics for Interactive Drama and Games."
- Mateas, Michael, and Andrew Stern. 2006. "Invited Talk : Facade: Architecture and Authorial Idioms for Believable Agents in Interactive Drama." In *Intelligent Virtual Agents*, 446–48.
- McCloud, Scott. 1994. *Understanding Comics: The Invisible Art*. Reprint. William Morrow Paperbacks.
- McMillan, Graeme. 2015. "The Flaws of Marvel's 'It's All Connected' Cinematic Universe." May 3.
- Mittell, Jason. 2006. "Narrative Complexity in Contemporary American Television." *The Velvet Light Trap* Number 58.
- . 2009. *Television & American Culture*. New York, N.Y: Oxford University Press.
- . 2012. "Playing for Plot in the Lost and Portal Franchises." *Eludamos. Journal for Computer Game Culture; Vol 6, No 1 (2012)*. <http://www.eludamos.org/index.php/eludamos/article/view/vol6no1-2/6>.
- . n.d. "Forensic Fandom and the Drillable Text." Blog. *Spreadable Media*. <http://spreadablemedia.org/essays/mittell/#.VOkEwN5Re-Q>.
- Moore, Ronald D. 2003. "Battlestar Galactica, Series Bible."
- Murphy, Kevin. 2013. Kevin Murphy Talks Syfy's TV Series/Transmedia Project "Defiance," Mythology Coordinators and the Second Season That's Already in the WorksWebsite. <http://www.indiewire.com/article/television/kevin-murphy-defiance-syfy>.
- Murray, Janet. 2011. "Transcending Transmedia Part 1." *Humanistic Design for an Emerging Medium*. November 19. <http://inventingthemedium.com/2011/11/19/transcending-transmedia-part-1/>.
- . 2012. "Transcending Transmedia : Emerging Story Telling Structures for the Emerging Convergence Platforms." In *EuroiTV '12 Proceedings of the 10th European Conference on Interactive Tv and Video*, 1–6. Berlin, Germany.
- Murray, Janet H. 1998. *Hamlet on the Holodeck: The Future of Narrative in Cyberspace*. Cambridge, Mass: MIT Press.

- Murray, Janet H. 2011. *Inventing the Medium: Principles of Interaction Design as a Cultural Practice*. The MIT Press. <http://dl.acm.org/citation.cfm?id=2132832>.
- New Media Age. 2010. "TRANSMEDIA: Starring Role." <http://www.californiachronicle.com/articles/yb/149649271>.
- Norman, Donald. 1988. *The Psychology of Everyday Things*. New York: Basic Books.
- Pearce, Celia. 1997. *The Interactive Book*. Indianapolis. McMillan Technical Publishing.
- Producers Guild of America. 2010. *Producers Code of Credits*. [http://www.producersguild.org/?page=coc\\_nm](http://www.producersguild.org/?page=coc_nm).
- Propp, V. ÎA. 1958. *Morphology of the Folktale*. International Journal of American Linguistics, v. 24, no. 4, pt. 3. Bloomington, Ind: Research Center, Indiana University.
- Rose, Frank. 2012. *The Art of Immersion: How the Digital Generation Is Remaking Hollywood, Madison Avenue, and the Way We Tell Stories*. Reprint. W. W. Norton & Company.
- Ruppel, Marc. 2012. "Visualizing Transmedia Networks: Links, Paths and Peripheries." University of Maryland.
- Ryan, Marie-Laure. 2001. "Beyond Myth and Metaphors: Narrativity in Digital Media." *Gamestudies*.
- . 2003. "On Defining Narrative Media." *Image & Narrative*, Medium Theory, , no. 6 (February). <http://www.imageandnarrative.be/inarchive/mediumtheory/marielauryan.htm>.
- . , ed. 2004. *Narrative Across Media: The Languages of Storytelling*. Frontiers of Narrative. Lincoln: University of Nebraska Press.
- . 2006a. *Avatars of Story*. Electronic Mediations, v. 17. Minneapolis: University of Minnesota Press.
- . 2006b. *Avatars of Story*. Electronic Mediations, v. 17. Minneapolis: University of Minnesota Press.
- . 2012. "Transmedial Storytelling and Transfictionality." Edited by Karl Renner. *Poetics Today* 34.3 (June): 362–88.
- . 2013. "Transmedia Storytelling: Myth or Reality?" In *Rethinking Intermediality in the Digital Age*.
- Siobhan O'Flynn. 2010. "Piece Adds New Elements to Definition – Don't Agree with All Myself: California Chronicle | Transmedia: Starring Role." *Transmediacamp 101*. September 13.
- Spivak, Josh. 2010. "Journey to The End, Chapter 2." *The Lost Flashbacks*. June 3. <http://thelostflashbacks.blogspot.com/>.

- Stenros, Jaakko, Jussi Holopainen, Annika Waern, Markus Montola, and Elina Ollila. 2011. "Narrative Friction in Alternate Reality Games: Design Insights from Conspiracy For Good." In *Think Design Play*.
- Sturken, Marita, and Lisa Cartwright. 2009. *Practices of Looking: An Introduction to Visual Culture*. 2nd ed. New York: Oxford University Press.
- Tolkien, J.R.R. 1966. "On Fairy Stories." In *The Tolkien Reader (Reissue Edition Ed.)*. New York: Del Rey.
- Vinge, Vernor. 2007. *Rainbows End*. First Thus. Tor Science Fiction.
- Vogler, Christopher. 2007. *The Writer's Journey: Mythic Structure for Writers*. 3rd edition. Michael Wiese Productions.
- Weiler, L. 2015. "Building Storyworlds: The Art, Craft & Biz of Storytelling in 21c." January 7. <https://medium.com/purposeful-storytelling-play/building-storyworlds-the-art-craft-biz-of-storytelling-in-21c-effb31b9904e>.
- Wolf, Mark J. P. 2013. *Building Imaginary Worlds: The Theory and History of Subcreation*. New York: Routledge.
- Wright, Ronald. 2004. *A Short History of Progress*. Toronto: House of Anansi Press.